

NORDITALIA RICAMBI

GENERAL CATALOGUE / CATALOGO GENERALE

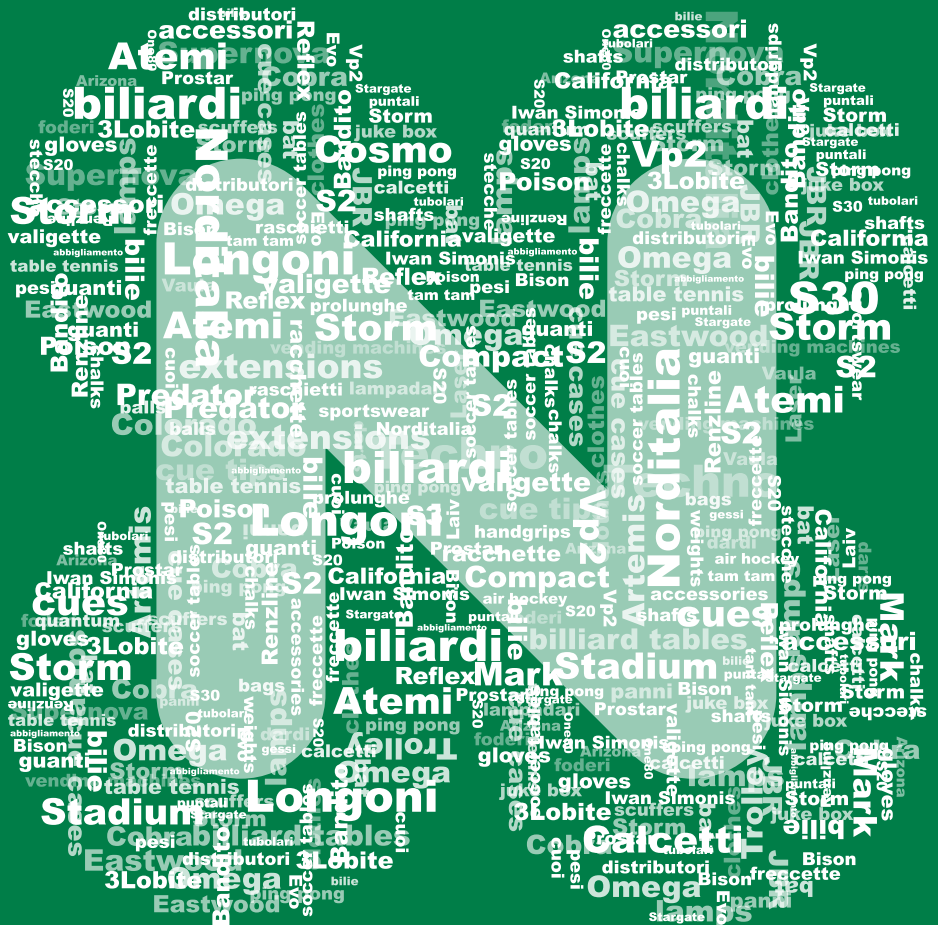



Billiard tables
Tavoli da biliardo



REVOLUTION

Best selling Italian style table. A real masterpiece of lombard cabinet-making: reinforced frame and first quality slate. It can be produced in several finishings, shades and selected dried essences: available for pool, carom and internazionale game. The legs are turned and, together with the aprons, they can be pickled on request. The "mascarons" are available in gold plated, silver plated and old-looking version.



Tavolo italiano per eccellenza. Un vero capolavoro di ebanisteria lombarda: telaio rinforzato e ardesia di prima qualità. Viene prodotto in diverse finiture, tonalità ed essenze selezionate ed essicate: disponibile per il gioco del pool, della carambola e dell'italiana/internazionale. Le gambe sono tornite sempre partendo dal massello. Fasce e gambe possono essere decapate a richiesta. I mascheroni sono disponibili nella versione dorata, argentata e antica.



P40 - P50 - NARCISO - CASINO'

Billiard tables suitable for every occasion, incomparable thanks to their quality and features. An absolute innovation both in the aesthetic and in the technical aspect. These tables are something amazing for lovers of the masterpiece. Multi-functional tables available in several materials (wood, steel, crystal and plexiglass) and colours. Perfect result between a billiard table and an object with sinuous shapes and rigorous playfield's geometry. P40 - P50 - NARCISO - CASINO' come out on request with a dining top that turns your pool table into a wonderful dining table, suitable for each kind of room. Completely built by Italian Masters. You can customize the size, material and colour of the tables.

P40 - P50 - NARCISO - CASINO'

I tavoli-biliardo per ogni occasione, inimitabili per qualità e prestazioni. Completamente rivoluzionari sia nella parte estetica che nella parte tecnica, sono biliardi strepitosi per gli amanti di oggetti unici. Oggetti polifunzionali declinati in tutte le varianti di materiale (legno, acciaio, cristallo e plexiglass) e di colore possibili. Perfetta sintesi tra tavolo di gioco, oggetto di forme sinuose e la rigorosa geometria del piano. Utile sia per il tempo libero, sia come tavolo da lavoro, sia come elemento d'arredo grazie alla versatilità ad adattarsi ad ogni tipo di ambiente. Completamente costruiti da maestri italiani. A richiesta personalizzabili nella misura, materiale e colore.

P40[®]





P50®



NARCISO®



CASINO[®]



Vivaldi



A billiard table is not a simple game but represents the life style of the owner. Vivaldi table has a typical Italian temper: smart and rebel. Out of all the classical schemes, it wants to be the right product for whom lives in an elegant and modern background. Developed to allow several matches of colours, it is available in 9 different leather's shades besides to antiqued leathers, both of reptiles and printed. Legs and frame can be finished in glossy metallized or pastel versions. Playfield and cushions can be covered with Simonis 860 cloth which, at present, has in the range more than 18 different colours. The Vivaldi model is from the pen of the architects Pozzoli Enzo and Cappelletti Giuliano, A.D.I members, in collaboration with the Longoni staff's technicians. To create a model aesthetically involving and technically functional was our aim. Now, prestige and fun to you! Available in different versions.

Il biliardo non è un semplice gioco ma rappresenta lo stile di vita di chi lo possiede. Vivaldi è nato con un carattere tipicamente italiano: elegante e ribelle. Rompendo tutti gli schemi classici vuole essere il prodotto giusto per chi vive un ambiente elegante e moderno. Sviluppato per consentire grande versatilità negli abbinamenti di colore è disponibile in 9 tonalità di cuoio oltre a pelli anticate, di rettile e stampate. Le gambe ed il telaio possono essere finiti lucidi metallizzati e pastello. Piano e sponde sono rivestibili con panno originale Simonis 860 che ha attualmente nella gamma oltre 18 varianti di colore. Il modello Vivaldi nasce dalla penna degli architetti Pozzoli Enzo e Cappelletti Giuliano, membri dell' A.D.I., in collaborazione con lo staff tecnico Longoni. Creare un modello esteticamente coinvolgente e tecnicamente funzionale è stato il nostro obiettivo. A voi il prestigio e il divertimento. Disponibile in diverse finiture.



Billiard table with minimal, but smart design, exceptional quality completed by extremely modern technologies. The table changes in a few seconds from an object of perfect design into a real and spacious dining table or into a professional billiard table. The lot studied to let you enjoy your home in the best possible way. Fusion is available with a steel structure painted in aluminium colour or, as alternative, in stainless steel. In both cases the cover top is realized in veneered wood, available in different versions.

Billardo dal design semplice ed elegante con una qualità eccezionale integrata da modernissime tecnologie. Si trasforma in pochi secondi da oggetto di design in una vera e spaziosa tavola da pranzo, in un tavolo da gioco o in un biliardo professionale. Il tutto studiato per farvi vivere al meglio la vostra casa. Fusion è disponibile con una struttura in acciaio verniciata color alluminio o in alternativa in acciaio inox. In entrambi i casi il piano di copertura è realizzato in legno impiallacciato disponibile in diverse essenze.





RED DEVIL

Entry-level product of Longoni range. Strong and essential style product, thanks to the scratch resistant formica, it is the perfect table for your leisure and game room, suitable for the whole family. Supplied with two pieces table top, always in scratch resistant formica. The legs in powder coated steel are each one adjustable to assure a perfect balance. Available in the pool or carom version, 6' and 7,5'.

E' il prodotto entry-level della gamma Longoni. Robusto e minimalista, grazie alla formica antigraffio si presta ad essere un ottimo prodotto per tutta la famiglia. Dotato di coperchio diviso in 2 parti sempre rivestito in formica antigraffio. Le 4 gambe in alluminio verniciato a polvere epossidica sono regolabili indipendentemente per un perfetto equilibrio. Disponibile nella variante pool o carambola, nella misura 6' e 7,5'.



RED DEVIL WENGE'

Inspired from the classic version "Red Devil", this table is always made of scratch resistant formica wengé with abs edging in the same colour. The choice of shaped corners has been made to better match the table to the nowadays modern furniture. Supplied with 3 pcs table top to make easier the handle of the billiard. Available in the pool or carom version, 6' and 7,5'.

Derivato dalla versione classica "Red Devil", questo tavolo è caratterizzato da una formica antigraffio wengé con bordatura abs in tinta. Gli angoli sagomati sono stati scelti per poterlo maggiormente abbinare agli arredamenti moderni. Dotato di coperchio diviso in 3 pezzi per facilitare ulteriormente le operazioni di trasformazione. Disponibile nella variante pool o carambola, nella misura 6' e 7,5'.





White oak / rovere sbiancato



Classic oak / rovere classico



NAPOLEON



Classic victorian style pool table, entirely made in oak. The 4 legs are completely hand inlaid and, thanks to the match with the structure and the cushions, they give to the table minimalistic aspect. The corners and the pockets are made of leather. Available in the pool version, 7' (classic oak) and 8' (white oak and classic oak).

Classico tavolo da pool in stile vittoriano, costruito interamente in rovere. Le 4 gambe sono intarsiate completamente a mano. Grazie al loro abbinamento con il cassone e le sponde donano uno stile sobrio a tutto il biliardo. Gli angolari e i cestelli di raccolta delle bilie sono interamente in cuoio. Disponibile nella variante pool, nella misura 7' (rovere classico) e 8' (rovere sbiancato e rovere classico).



BISMARCK



Table with marked lines, supplied with a strong frame, it is a billiard suitable not only for home use, but also for clubs. The pockets, in the pool version, are in the classic American style with fringes in the same colour as table body. Easy to disassemble and to be mounted even in that rooms which are not easily reachable. Available in the pool 8'.

Tavolo dalle linee squadrate, dotato di robusto telaio, è un biliardo adatto non solo ad abitazioni ma anche a circoli e club. I cestelli di raccolta, nella versione pool, sono in classico stile americano con frangette in tinta con il cassone. Totalmente smontabile e facile da assemblare anche nei locali poco accessibili. Disponibile nella misura pool 8'.



PATRIOT

Elegant billiard table made of solid wood with mahogany and cognac colour finishing. The pool is decorated with tasteful inlays situated on the lateral cushions and majestic legs which enrich even more the imagine of this product. Available in the pool 8' or carom version, 7,5'.

Elegante biliardo in legno massello con finiture colore mogano-cognac. Tavolo di ottimo gusto impreziosito da inserti sulle fasce laterali e sulle gambe imponenti che arricchiscono ancora di più l'immagine di questo prodotto. Disponibile nella variante pool 8' e carambola 7,5'.



VERNON

Elegant matt black lacquered table made of solid wood with brown inlays on cushions and pockets. Supplied with leathered black pocket. Its untraditional design makes it even more interesting. Available in the pool 8'.

Elegante biliardo in legno massello laccato nero opaco con giochi di inserti marroni sulla sponda e sui pocket. Dotato di cestelli interni in pelle nera. Il design non tradizionale lo rende ancora più interessante. Disponibile nella variante pool 8'.





CAMELOT

French style table with squared lines for the pool game. Characterised by an elegant and simple style, this table is completely produced in solid wood with old-looking walnut finish. A piece of furniture which quickly becomes a big and comfortable dining table with top cover in 3pcs (included in the billiard table) to make the installation easier. Practical to valorize every kind of room or basement room. Available in the pool version, 7' and 8'.

Biliardo per il gioco del pool in stile francese caratterizzato dalle linee squadrate. Uno stile elegante e semplice caratterizza l'aspetto di questo tavolo completamente costruito in legno massello con finitura in noce anticata. Mobile che diventa velocemente un grande e comodo tavolo da pranzo con copertura (inclusa nel biliardo) in legno in 3 pezzi per facilitare il montaggio. Pratico per valorizzare ogni tipo di salone o taverna. Disponibile nella variante pool, nella misura 7' e 8'.



ELYSEE

Original and innovative billiard table for the pool game. Completely in beech wood with honey finish, this table is equipped with high quality leather black pockets. A piece of furniture which quickly becomes a big and comfortable dining table with top cover in 3pcs (included in the billiard table) to make the installation easier. Practical to enhance every kind of room or basement room. Available in the pool version, 7' and 8'.

Biliardo originale e innovativo per il gioco del pool. Completamente costruito in legno di faggio con finitura miele, con pocket a vista in pelle di qualità color nero. Caratterizzato da un mobile che diventa velocemente un grande e comodo tavolo da pranzo con copertura (inclusa nel biliardo) in legno in 3 pezzi per facilitare il montaggio. Pratico per valorizzare ogni tipo di salone o taverna. Disponibile nella variante pool, nella misura 7' e 8'.





NOIR

Original and innovative billiard table for the pool game. Completely in black matt solid wood, it is equipped with high quality leather black pockets. A piece of furniture which quickly becomes a big and comfortable dining table with top cover in 3pcs (included in the billiard table) to make the installation easier. Practical to enhance every kind of room or basement room. Available in the pool version, 7' and 8'.

Biliardo originale e innovativo per il gioco del pool. Completamente costruito in legno massello laccato nero opaco con pocket a vista in pelle di qualità color nero. Caratterizzato da un mobile che diventa velocemente un grande e comodo tavolo da pranzo con copertura (inclusa nel biliardo) in legno in 3 pezzi per facilitare il montaggio. Pratico per valorizzare ogni tipo di salone o taverna. Disponibile nella variante pool, nella misura 7' e 8'.



NEW MEXICO

Table suitable if you want to enter in the billiard world, good value for money. It is supplied with accessories and cloth (only burgundy) already mounted. It is easy to handle and the mdf playing field gives to the table stability and lightness. For this reason it is suitable to be located also in certified loft. Available in 7' pool size only. Equipped with 2 cues of 145 cm, 1 balls set with a diameter of 57 mm, 1 wooden ball triangle and 2 chinks.

Tavolo adatto a chi vuole avvicinarsi al gioco del biliardo con un investimento limitato. E' fornito completo di accessori e con panno (unicamente di colore bordeaux) montato. E' di facile installazione e il piano in mdf rende il tavolo stabile e leggero, adatto anche per essere montato su soppalchi certificati. Disponibile nella sola misura pool 7'. Fornito con 2 stecche da 145 cm, 1 set di bilie diametro 57 mm, 1 triangolo e 2 gessi.



Oak version
Versione rovere



Black version
Versione nera

TORONTO

Table suitable if you want to enter in the billiard world, good value for money. It is supplied with accessories and cloth (only green) already mounted. It is easy to handle and the MDF playing field gives the table stability and lightness. For this reason it is suitable to be located also in certified lofts. Available in 6' pool size only. Equipped with 2 cues of 145 cm, 1 balls set with a diameter of 57 mm, 1 wooden ball triangle, 2 chinks and one table plastic brush.

Tavolo adatto a chi vuole avvicinarsi al gioco del biliardo con un investimento limitato. E' fornito completo di accessori e con panno (unicamente di colore verde) montato. E' di facile installazione ed il piano in MDF rende il tavolo stabile e leggero, adatto anche per essere montato su soppalchi certificati. Disponibile nella sola misura pool 6'. Fornito con 2 stecche da 145 cm, 1 set di bilie diametro 57 mm, 1 triangolo, 2 gessi ed una spazzola in plastica.



CHALLENGER

Amazing pool billiard table with a modern and linear style suitable for an home use. Solid wood cushions and upper cushions covered in fireproof and anti-scratch laminated formica, cushions and legs both in MDF. Enriched with corners, profiles and adjustable feet for a perfect levelling all of them in aluminium alloy. Equipped with 3 pieces, 25 mm slate and cushions model K66 for a perfect playing geometry. The table does not include cloth and accessories. Available in 9' size only.

Splendido pool in stile moderno e lineare ad uso domestico. Biliardo con sponde in legno massello, sponde superiori rivestite in formica laminata ignifuga e antigraffio, fasce e gambe in MDF. Arricchito da angolari, profili e piedini regolabili per una perfetta livellatura tutti in lega di alluminio. Dotato di piano in ardesia diviso in 3 pezzi da 25 mm e sponde modello K66 per una perfetta geometria di gioco. Il tavolo non include panno e accessori. Disponibile nella sola misura 9'.



CHARME

Solid billiard table, original and innovative for the pool game. Furnishing element entirely built in MDF with anti-scratch finishing in three different colors: white, oak or Grey. Characterised by a structure that fastly become a big and comfortable dining table with a cover easy to assemble. Equipped with squared legs with adjustable feet for a perfect levelling; the slate is composed by one piece of 19 mm with possibility to choose the color of the cloth (dark red, green or blue). Available in the only version 6'. Optional extra: kit that allowed to transform the pool billiard table into a carom billiard table.

Solido biliardo, originale ed innovativo per il gioco del pool. Complemento d'arredo completamente costruito in MDF con a scelta rifinitura antigraffio color bianca, rovere o grigia. Facile da assemblare, il biliardo diventa velocemente un grande e comodo tavolo da pranzo con coperchio in 2 pezzi. Dotato di gambe squadrate con piedini regolabili per un perfetto livellamento; ardesia ad un 1 pezzo, 19 mm di spessore con possibilità di scelta del colore del panno (rosso scuro, verde o blu). Disponibile nell'unica misura 6'. Optional extra: il kit per trasformare il biliardo da pool a carambola.



ATLANTA

Billiard pool table entirely in brown pine wood suitable to become the center of maximum attraction in every room of your home. Equipped with a cover to turn into a splendid dining table.

The multi-step finishing process brings out the natural luster and beauty of the wood grain.

The legs of the table add an aesthetic value and with the addition of metal rods and stringers they guarantee exceptional stability.

The cushions, which mount the K66 professional rubbers specific for tournaments, are fixed at three different points to the slate, giving the ball the maximum response on the table.

The three-piece 25 mm slate combined with the massive wooden structure of the table, offers maximum stability and strength.

The cloth is resistant to the scratches of the sticks, to the traces of the balls and to the day-to-day use.

To enrich the table structure there are metal plates and pockets in genuine leather.

Available in 8' size only.

Optional: matching bench/ accessories holder.

Tavolo da pool interamente in legno di pino marrone adatto per diventare il centro di massima attrazione in ogni stanza della tua abitazione. Dotato di coperchio per trasformarsi in uno splendido tavolo da pranzo.

La lavorazione di rifinitura multi-strato valorizza la naturale lucentezza e bellezza delle venature del legno.

Le gambe del tavolo aggiungono un valore estetico e con l'aggiunta di aste e traversi in metallo garantiscono un'eccezionale stabilità.

Le sponde, che montano la gomma professionale K66 specifica per i tornei, sono fissate in tre diversi punti all'ardesia, dando alla bilia la massima risposta sul tavolo.

L'ardesia in 3 pezzi da 25 mm abbinata alla massiccia struttura in legno del tavolo, offre una massima stabilità e forza.

Il panno è resistente ai graffi delle stecche, alle tracce delle bilie e all'utilizzo quotidiano.

Ad arricchire la struttura del tavolo sono presenti placche in metallo e buche in vera pelle.

Disponibile nell'unica misura in 8'.

Optional: panca in tinta.



Brown oak version / versione rovere marrone



BOSTON

Billiard pool table entirely in oak suitable to become the center of maximum attraction in every room of your home. Equipped with a cover to turn into a splendid dining table. The multi-step finishing process brings out the natural luster and beauty of the wood grain. The table legs add an aesthetic value thanks to the play of curves and with their resilience guarantee an exceptional stability.

The cushions, which mount the K66 professional rubbers specific for tournaments, are fixed at three different points to the slate, giving the ball the maximum response on the table.

The three-piece 25 mm slate combined with the massive wooden structure of the table, offers maximum stability and strength. The structure of the table is enriched with ebony inlays and pockets in genuine leather.

Available in 8' size only. Available colors: brown oak (with cover) and gray oak (without cover). Optional: matching bench / accessory holder.

Tavolo da pool interamente in rovere adatto per diventare il centro di massima attrazione in ogni stanza della tua abitazione. Dotato di coperchio per trasformarsi in uno splendido tavolo da pranzo. La lavorazione di rifinitura multi-strato valorizza la naturale lucentezza e bellezza delle venature del legno. Le gambe del tavolo aggiungono un valore estetico grazie al gioco di curve e con la loro robustezza garantiscono un'eccezionale stabilità. Le sponde, che montano la gomma professionale K66 specifica per i tornei, sono fissate in tre diversi punti all'ardesia, dando alla bilia la massima risposta sul tavolo. L'ardesia in 3 pezzi da 25 mm abbinata alla massiccia struttura in legno del tavolo, offre una massima stabilità e forza. Ad arricchire la struttura del tavolo sono presenti intarsi in ebano e buche in vera pelle. Disponibile nell'unica misura in 8'. Colorazioni disponibili: rovere marrone (con coperchio) e rovere grigio (senza coperchio). Optional: panca in tinta.



NEBRASKA

Billiard pool table entirely in solid pine wood suitable to become the center of maximum attraction in every room of your home.

The multi-step finishing process brings out the natural luster and beauty of the wood grain.

The table legs add an aesthetic value and with triple anchor support they guarantee exceptional stability.

The cushions, which mount the K66 professional rubber specific for tournaments, are fixed at three different points to the slate, giving the ball the maximum response on the table.

The three-piece 25 mm slate combined with the massive wooden structure of the table, offers maximum stability and strength.

The structure of the table is enriched by diamond inlays and pockets in genuine leather.

Available in 8' size only.

Tavolo da pool interamente in legno di pino massiccio adatto per diventare il centro di massima attrazione in ogni stanza della tua abitazione.

La lavorazione di rifinitura multi-strato valorizza la naturale lucentezza e bellezza delle venature del legno.

Le gambe del tavolo aggiungono un valore estetico e con il triplo supporto garantiscono un'eccezionale stabilità.

Le sponde, che montano la gomma professionale K66 specifica per i tornei, sono fissate in tre diversi punti all'ardesia, dando alla bilia la massima risposta sul tavolo.

L'ardesia in 3 pezzi da 25 mm abbinata alla massiccia struttura in legno del tavolo, offre una massima stabilità e forza.

Ad arricchire la struttura del tavolo sono presenti intarsi di metallo diamantato e buche in vera pelle.

Disponibile nell'unica misura 8'.



WYOMING

Billiard pool table entirely in pine wood with antique honey finishing suitable to become the center of maximum attraction in every room of your home.

The multi-step finishing process bring out the natural luster and beauty of the wood grain.

The essentiality of the legs make the aesthetics of this model the most "light" of the "American Style" range.

The cushions, which mount the K66 professional rubbers specific for tournaments, are fixed at three different points to the slate, giving the ball the maximum response on the table.

The three-piece 25 mm slate combined with the massive wooden structure of the table, offers maximum stability and strength.

To enrich the structure of the table there are inlays and pockets in genuine leather.

Available in 8' size only.

Tavolo da pool interamente in legno di pino con finitura in miele antico adatto per diventare il centro di massima attrazione in ogni stanza della tua abitazione.

La lavorazione di rifinitura multi-strato valorizza la naturale lucentezza e bellezza delle venature del legno.

L'essenzialità delle gambe rendono l'estetica di questo modello la più "leggera" della gamma "American Style".

Le sponde, che montano la gomma professionale K66 specifica per i tornei, sono fissate in tre diversi punti all'ardesia, dando alla bilia la massima risposta sul tavolo.

L'ardesia in 3 pezzi da 25 mm abbinata alla massiccia struttura in legno del tavolo, offre una massima stabilità e forza.

Ad arricchire la struttura del tavolo sono presenti intarsi e buche in vera pelle.

Disponibile nell'unica misura: 8'.



GEORGIA

There is no need to compromise when choosing the Georgia table for the home billiard room. All the quality and details are there: load-bearing frame in solid wood, slate top 25 mm thick divided into 3 pieces for an easy installation, external covering with clean and strong lines in solid wood with two-tone finishing, squared legs, leather pockets, abalone inlays. Available in the only size 8'.

GEORGIA: Non è necessario scendere a compromessi quando si sceglie il tavolo Georgia per la sala da biliardo di casa. Tutta la qualità e i dettagli ci sono: telaio portante in legno massello, piano di gioco in ardesia spessore 25 mm divisa in 3 pezzi per una facile installazione, rivestimento esterno dalle linee pulite e forti in legno massello con finitura bicolore, gambe squadrate, buche in pelle, intarsi in abalone. Disponibile nell'unica misura 8'.



SNOOKER SHETLAND XV

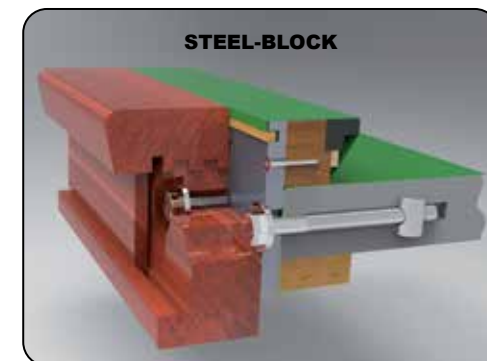

Shetland is a fantastic snooker table manufactured in solid wood and finished in an elegant mahogany colour. The slate (easy to be mounted) is rectified and thick so that the table is stable and longlasting. The style of the table is typical English style: high professional game mixed with elegance.

Each turned leg is equipped with leg levellers and this grants also stability to the table. For this table, we suggest original Simonis Snooker cloth (optional) for a precise and good quality of the game. Available in two sizes: 10' and 12'.

Shetland è un fantastico tavolo da snooker costruito interamente in solido legno massello di faggio rifinito in tinta mogano. L'ardesia di facile installazione è rettificata e molto spessa in modo da rendere il tavolo altamente stabile e duraturo nel tempo. Poggiato su gambe tornite, questo biliardo dal look classico inglese si presta ad un gioco altamente professionale senza perdere il fascino dell'eleganza. Ogni gamba è dotata di un piedino regolabile per garantire un piano perfettamente livellato. Su richiesta disponibile con panno originale Simonis (opzionale), suggerito dal nostro staff per un gioco preciso e di qualità. Disponibile nella misura da 10' o 12'.

Art.	Size Misura	Version Versione	Legs Gambe	External sizes Mis. Esterne	Playingfield Campo gioco	Slate Ardesia	Slate weight Peso ardesia	H. Playingfield H. Piano gioco	Total weight Peso totale	Acc. included Acc. inclusi
3505	10'	Mahogany Mogano	6	323 X 174 cm	294,8 X 146,4 cm	3 pcs / pz 38 mm	645 Kg ca.	84,5 cm ca.	890 kg	-
15884	12'	Mahogany Mogano	8	387 X 208 cm	356 X 178 cm	5 pcs / pz 45 mm	795 Kg ca.	84,5 cm ca.	1100 kg	-

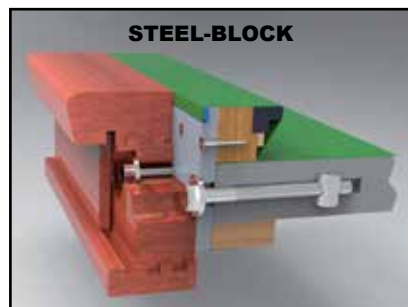

GOLD CAVALIER

Billiard table for professional use completely made of solid wood, designed with competition sizes and made in perfect style and contemporary design.

The billiard table is in classic mahogany color embellished with gold-colored shades and it has 6 holes enhanced by a leather cover.

Equipped with high quality slate with a thickness of 42 mm covered with the 6811 English snooker cloth and adjustable wooden feet that allow a perfect leveling.

This model of tavolo da biliardo garantisce special playing features of play and speed thanks to the 12 mm metal plate located in the cushion ("steel block"), which will surely satisfy the most demanding players.

Available in 9' size.

Tavolo da biliardo ad uso professionale interamente in legno massello, progettato con misure da competizione e realizzato in perfetto stile e design contemporaneo.

Il biliardo è in tinta color mogano classico impreziosito da sfumature color oro e dotato di 6 buche valorizzate dal rivestimento in pelle.

Dotato di piano in ardesia di alta qualità con spessore di 42 mm rivestito con il panno da snooker inglese 6811 e piedini in legno regolabili che consentono una perfetta livellatura.

Questo modello di tavolo da biliardo garantisce speciali caratteristiche di gioco e velocità grazie alla piastra di metallo da 12 mm situata nella sponda ("steel block"), che soddisferà di sicuro i giocatori più esigenti.

Disponibile nella misura 9'.

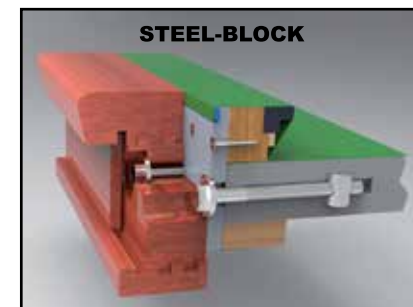

GOLD PHOENIX

Billiard table for professional use with high density solid wood sides and sturdy wooden frame.

Designed with tournaments sizes, the billiard table is finished in a black color with red oak geometric plays, enriched by brushed nickel metal elements and 6 holes enhanced by leather upholstery, all to show the modern and fashionable style .

Equipped with a high quality slate top with a thickness of 42 mm covered with the English snooker cloth 6811.

This model of billiard table guarantees special features of play and speed thanks to the 12 mm metal plate located in the bank ("steel block"), which will surely satisfy the most demanding players.

Available in 9' size.

Tavolo da biliardo ad uso professionale con sponde in legno massello ad alta densità e robusto telaio in legno.

Progettato con misure da competizione, il biliardo è rifinito in tinta color nera con giochi geometrici in legno di quercia rossa, arricchito dagli elementi di metallo in nichel spazzolato e dalle 6 buche valorizzate dal rivestimento in pelle, tutto per mostrare lo stile moderno e alla moda.

Dotato di piano in ardesia di alta qualità con spessore di 42 mm rivestito con il panno da snooker inglese 6811.

Questo modello di tavolo da biliardo garantisce speciali caratteristiche di gioco e velocità grazie alla piastra di metallo da 12 mm situata nella sponda ("steel block"), che soddisferà di sicuro i giocatori più esigenti.

Disponibile nella misura 9'.



THE POOL TABLE

My table choice
— *Nick Fejer* —

Club "Tour Edition"

A MASTERPIECE
UN'OPERA D'ARTE

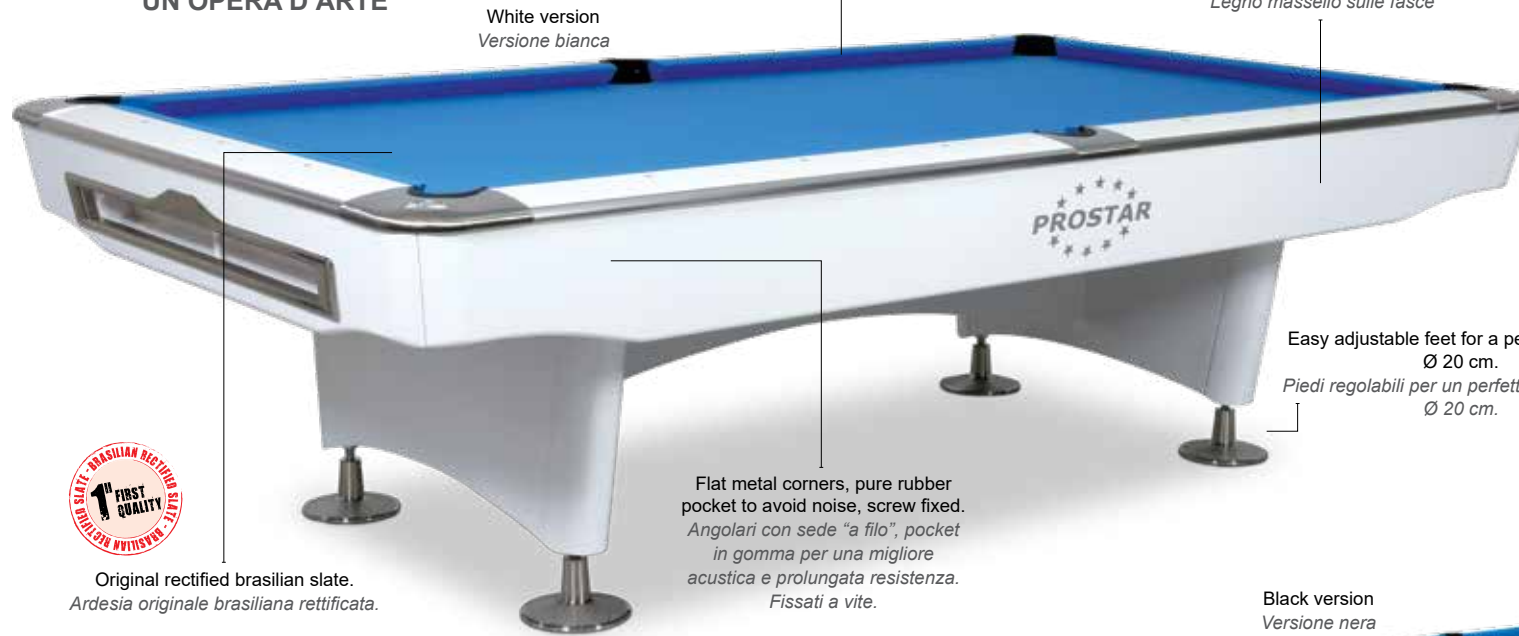

White version
Versione bianca

Anti-aging pro cushions.
Gomme professionali a lunga durata.

Solid wood on the sides
Legno massello sulle fasce

Easy adjustable feet for a perfect leveling.
Ø 20 cm.
Piedi regolabili per un perfetto livellamento.
Ø 20 cm.

Flat metal corners, pure rubber pocket to avoid noise, screw fixed.
Angolari con sede "a filo", pocket in gomma per una migliore acustica e prolungata resistenza. Fissati a vite.



Original rectified brasilian slate.
Ardesia originale brasiliana rettificata.



"Heavy duty" slate frame, which can be totally disassembled.
Telaio in legno compensato ad altissima resistenza, completamente smontabile.



24 Adjustment points of the slates
24 Punti di regolazione delle ardesie.



Black version
Versione nera

Prostar suggests Simonis original cloth
Prostar suggerisce panno originale Simonis.



Mahogany version
Versione mogano

Pocket sizes.
Misure pocket.

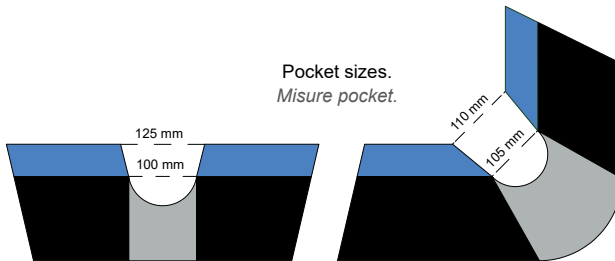

Prostar Club Tour Edition has been developed as an evolution of the previous production. The strong structure of the frame has been even more reinforced adding the possibility to adjust the slate level thanks to its 24 screws distributed in the key points. The diameter of the pockets has been narrowed as required by the new international standard rules. More elastic and strong rubbers allowed to improve the game strategy. All the components are in brushed stainless steel to grant a longer lifetime. To play billiard on the Club Tour Edition table will be even more funny and your investment will be assured for a long time.

Il pool Prostar Club tour edition è stato sviluppato come evoluzione della precedente serie. La robusta struttura del telaio è stata ulteriormente rinforzata aggiungendo anche la possibilità di regolare il livello dell'ardesia grazie a 24 viti distribuite nei punti chiave. L'entrata delle buche è stata ristretta come richiesto dai nuovi standard internazionali. Gomme piu' elastiche e resistenti hanno permesso di migliorare le traiettorie di gioco. Tutti i particolari sono in acciaio spazzolato per garantire una maggiore resistenza nel tempo. Giocare a pool sul tavolo Club Tour Edition sarà ancora piu' divertente ed il vostro investimento sarà assicurato nel tempo.



Electronic system of balls ejection
Sistema elettronico di espulsione bilie



SINCE 1680
Simonis
SIMONIS CLOTH

Simonis 860 grey cloth (included)
Panno Simonis 860 grigio (incluso)

NEW YORK

The New York pool is one of the best coin-op tables ever. Completely built in high quality plywood and covered with antiscratch formica, this table shows a New York headquarter on its sides. Aluminium cushions covered with antiscratch black formica and high precision American rubber. Fiberglass black varnished legs with leg levellers adjustable in height. Rectified one-piece diamond slate covered with Simonis 860 grey cloth (included). The electronic system of the coinshute provides an excellent reliability to the ejection balls mechanism. Internal system with magnetic ball ejection. Cushions set easy to open for a quicker replacement of the cloth. In its standard version the table is equipped with mechanic 2 € coinshute. Available in the pool version, both 7' and 8'.

Accessories included: 4 cues, 1 pool 57 mm balls set, 1 triangle, 1 brush, 1 cue rack for 4cues, 1 box of 12 pcs chalk, 1 plastic cover.

Il pool New York e' considerato tra i migliori tavoli con gettoniera del settore. E' completamente costruito in compensato di qualita' e rivestito in formica antigraffio raffigurante un quartiere di New York. Le sponde sono in estruso di alluminio rivestite con formica nera antigraffio e con gomme americane di alta precisione sulle sponde. Gambe in fibra di vetro verniciate nere con piedini regolabili in altezza. Ardesia rettificata al diamante ad un pezzo rivestita con panno Simonis 860 grigio (incluso). Il sistema elettronico della gettoniera per l'espulsione delle bilie fornisce un'altissima affidabilita' al meccanismo di espulsione. Sistema interno con espulsione pallino magnetico. Facile apertura del gioco sponde per una piu' rapida sostituzione del panno. Nella versione standard il tavolo e' fornito con gettoniera meccanica a 2 euro. Disponibile nella variante pool, nella versione 7' e 8'.

Accessori inclusi: 4 stecche, 1 gioco di bilie da pool 57mm, 1 triangolo, 1 spazzola, 1 portastecche a 4posti, 1 scatola da 12 cubetti di gesso, 1 coperta in plastica.

MODEL MODELLO	POOL / ITALIANA	CAROM	SIZE MISURA	COLOUR / VERSION COLORE / VERSIONE	EXTERNAL SIZE MISURE EXT.
ATLANTA	15213	-	8'	brown pine finish/finitura pino marrone	256 x 144 cm
BISMARCK	15913	-	8'	walnut/noce	252 x 140 cm
BOSTON	15211	-	8'	brown oak/rovere marrone	256 x 144 cm
	15212	-	8'	grey oak/rovere grigio	256 x 144 cm
CAMELOT	15997	-	7'	noce anticata	230 x 130 cm
	15992	-	8'	noce anticata	254 x 142 cm
CHALLENGER	16736	-	9'	matt black/nero opaco	286 x 159 cm
CHARME	15219	-	6'	oak or grey/rovere o grigio	200 x 116 cm
ELYSEE	15990	-	7'	honey finish/finitura miele	235 x 135 cm
	15996	-	8'	honey finish/finitura miele	254 x 142 cm
GEORGIA	15210	-	8'	dark driftwood/legno scuro	253 x 141 cm
NAPOLEON	15908	-	7'	classic oak/rovere classico	232 x 130 cm
	15921	-	8'	classic oak/rovere classico	252 x 140 cm
	15909	-	8'	white oak/rovere sbiancato	252 x 140 cm
NEBRASKA	15207	-	8'	pine/pino	256 x 144 cm
NEW MEXICO	15907	-	7'	black/nero	223 x 125 cm
NEW YORK	15927	-	7'	manhattan	232 X 133 cm
	15924	-	8'	manhattan	254 x 142 cm
NOIR	16505	-	7'	matt black/nero opaco	230 x 130 cm
	16506	-	8'	matt black/nero opaco	259 x 147 cm
PATRIOT	-	15970	7,5'	mogano-cognac	240 x 135 cm
	15971	-	8'	mogano-cognac	254 x 142 cm
PROSTAR CLUB TOUR EDITION	16503	-	8'	black/nero	260 x 148 cm
	16502	-	9'	black/nero	290 x 163 cm
	16504	-	8'	mahogany/mogano	260 x 148 cm
	16501	-	9'	mahogany/mogano	290 x 163 cm
	16507	-	9'	white/bianco	290 x 163 cm
RED DEVIL	15133	-	6'	matt black/nero opaco	216 x 125 cm
	15120	-	7,5'	matt black/nero opaco	239 x 134 cm
RED DEVIL WENGE'	15200	-	6'	wengé	216 x 125 cm
	15199	-	7,5'	wengé	239 x 134 cm
REVOLUTION	15513	-	10'	solid wood/massello	305 x 170 cm
TORONTO	16320	-	6'	oak /rovere	183 x 103 cm
	16321	-	6'	black/nero	183 x 103 cm
VERNON	15973	-	8'	matt black/nero opaco	254 x 142 cm
VIVALDI	15536	-	10'	(pag 8-9)	314 x 172 cm
WYOMING	15209	-	8'	antique honey / miele antico	256 x 144 cm

PLAYINGFIELD CAMPO GIOCO	SLATE ARDESIA	SLATE WEIGHT PESO ARDESIA	H PLAYINGFIELD H PIANO GIOCO	TOTAL WEIGHT PESO TOTALE	ACCESS. INCLU. ACC. INCLUSI	DINING TOP COPERCHIO
224 x 112 cm	3 pcs/pz 25 mm	ca. 288 kg	ca. 75/77 cm	437 kg	no	yes / si
224 x 112 cm	3 pcs/pz 25 mm	ca. 228 kg	ca. 75/77 cm	354 kg	no	no
224 x 112 cm	3 pcs/pz 25 mm	ca. 288 kg	ca. 75/77 cm	438 kg	no	yes / si
224 x 112 cm	3 pcs/pz 25 mm	ca. 288 kg	ca. 75/77 cm	438 kg	no	no
200 x 100 cm	3 pcs/pz 19 mm	ca. 171 kg	ca. 75 cm	350 kg	no	yes / si
224 x 112 cm	3 pcs/pz 19 mm	ca. 213 kg	ca. 75 cm	400 kg	no	yes / si
254 x 127 cm	3 pcs/pz 25 mm	-	ca. 75 cm	437 kg	no	no
172 x 86 cm	1 pc/pz 19 mm	-	ca. 75 cm	175 kg	no	yes / si
200 x 100 cm	3 pcs/pz 19 mm	ca. 171 kg	ca. 75 cm	350 kg	no	yes / si
224 x 112 cm	3 pcs/pz 19 mm	ca. 213 kg	ca. 75 cm	400 kg	no	yes / si
224 x 112 cm	3 pcs/pz 25 mm	ca. 288 kg	ca. 75/77 cm	411 kg	no	no
198 x 99 cm	3 pcs/pz 25 mm	ca. 178 kg	ca. 75/77 cm	299 kg	no	no
224 x 112 cm	3 pcs/pz 25 mm	ca. 215 kg	ca. 75/77 cm	354 kg	no	no
224 x 112 cm	3 pcs/pz 25 mm	ca. 215 kg	ca. 75/77 cm	354 kg	no	no
224 x 112 cm	3 pcs/pz 25 mm	ca. 288 kg	ca. 75/77 cm	434 kg	no	no
198 x 99 cm	MDF 17 mm	-	ca. 75 cm	130 kg	yes / si	no
198 x 99 cm	1 pc/pz 22 mm	ca. 142 kg	ca. 75/77 cm	309 kg	yes / si	no
224 x 112 cm	1 pc/pz 22 mm	ca. 173 kg	ca. 75/77 cm	380 kg	yes / si	no
200 x 100 cm	3 pcs/pz 19 mm	ca. 171 kg	ca. 75 cm	350 kg	no	yes / si
224 x 112 cm	3 pcs/pz 19 mm	ca. 213 kg	ca. 75 cm	400 kg	no	yes / si
210 x 105 cm	3 pcs/pz 40 mm	ca. 294 kg	ca. 74/77 cm	430 kg	no	no
224 x 112 cm	3 pcs/pz 24 mm	ca. 228 kg	ca. 74/77 cm	390 kg	no	no
224 x 112 cm	3 pcs/pz 25 mm	ca. 215 kg	ca. 75/77 cm	365 kg	no	no
254 x 127 cm	3 pcs/pz 25 mm	ca. 275 kg	ca. 75/77 cm	420 kg	no	no
224 x 112 cm	3 pcs/pz 25 mm	ca. 215 kg	ca. 75/77 cm	365 kg	no	no
254 x 127 cm	3 pcs/pz 25 mm	ca. 275 kg	ca. 75/77 cm	420 kg	no	no
254 x 127 cm	3 pcs/pz 25 mm	ca. 275 kg	ca. 75/77 cm	420 kg	no	no
180 x 90 cm	1 pc/pz 19 mm	ca. 114 kg	ca. 75/77 cm	254 kg	no	yes / si
210 x 105 cm	1 pc/pz 19 mm	ca. 155 kg	ca. 75/77 cm	332 kg	no	yes / si
180 x 90 cm	1 pc/pz 19 mm	ca. 114 kg	ca. 75/77 cm	260 kg	no	yes / si
210 x 105 cm	1 pc/pz 19 mm	ca. 155 kg	ca. 75/77 cm	338 kg	no	yes / si
284 x 142 cm	3 pcs/pz 40 mm	ca. 520 kg	ca. 75/77 cm	1100 kg	no	no
160 x 80 cm	MDF 18 mm	-	ca. 75 cm	70 kg	yes / si	no
160 x 80 cm	MDF 18 mm	-	ca. 75 cm	70 kg	yes / si	no
224 x 112 cm	3 pcs/pz 24 mm	ca. 228 kg	ca. 74/77 cm	360 kg	no	no
284 x 142 cm	5 pcs/pz 45 mm	ca. 750 kg	ca. 78 cm	1200 kg	no	no
224 x 112 cm	3 pcs/pz 25 mm	ca. 288 kg	ca. 75/77 cm	434 kg	no	no

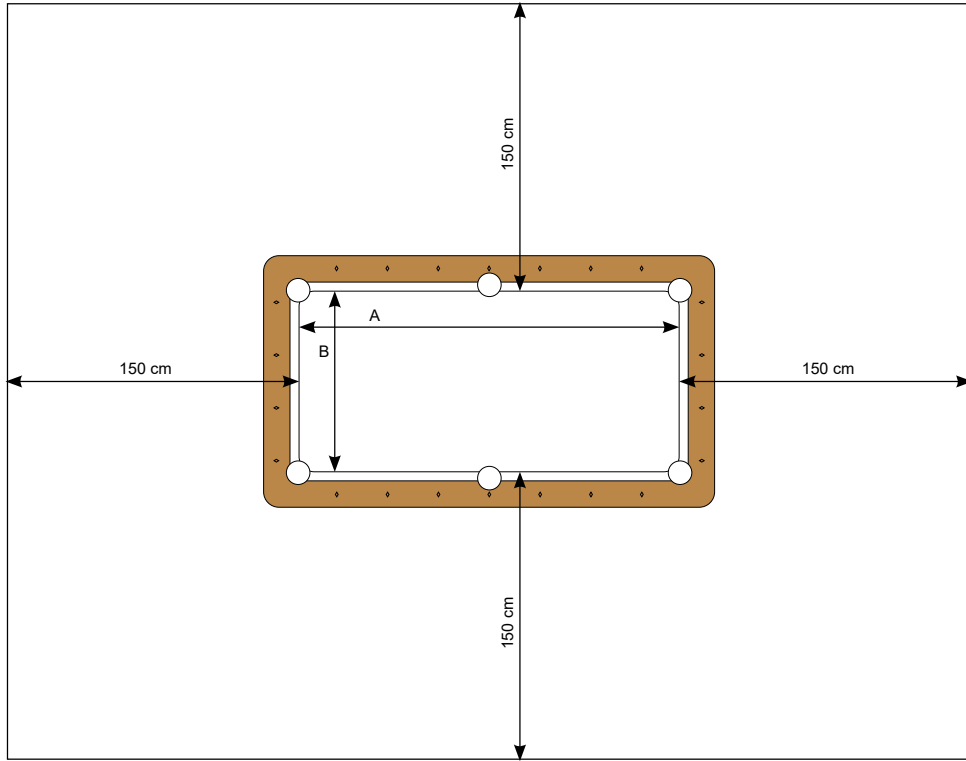



Size Misura	A	B	Room size Misure stanza
6'	180 cm	90 cm	5 X 4 m
7'	198 cm	99 cm	5 X 4 m
7,5'	210 cm	105 cm	5 X 4 m
8'	224 cm	112 cm	6 X 4 m
9'	254 cm	127 cm	6 X 6 m
10'	284 cm	142 cm	6 X 5 m
12'	360 cm	180 cm	7 X 5 m



Lamps & accessories
Lampadari & accessori

MILANO MADE IN ITALY



NEON LIGHT / NEON 						NORMAL LIGHT / LUCE NORMALE 					
1	2	3	4	5	6	1	2	3	4	5	6
-	10004	10070	10058	10129	10296	10001	10003	10036	10146	10167	10294

SHADE COLOURS / COLORI CAMPANA



ROD COLOURS / COLORI ASTA



PARIGI MADE IN ITALY



NEON LIGHT / NEON 					NORMAL LIGHT / LUCE NORMALE				
1	2	3	4	5	1	2	3	4	5
10159	10130	10131	10132	10133	-	-	10078	10271	-

SHADE COLOURS / COLORI CAMPANA



ROD COLOURS / COLORI ASTA



AMSTERDAM MADE IN ITALY





1 	10053
---------------------------------------------------------------------------------------	-------

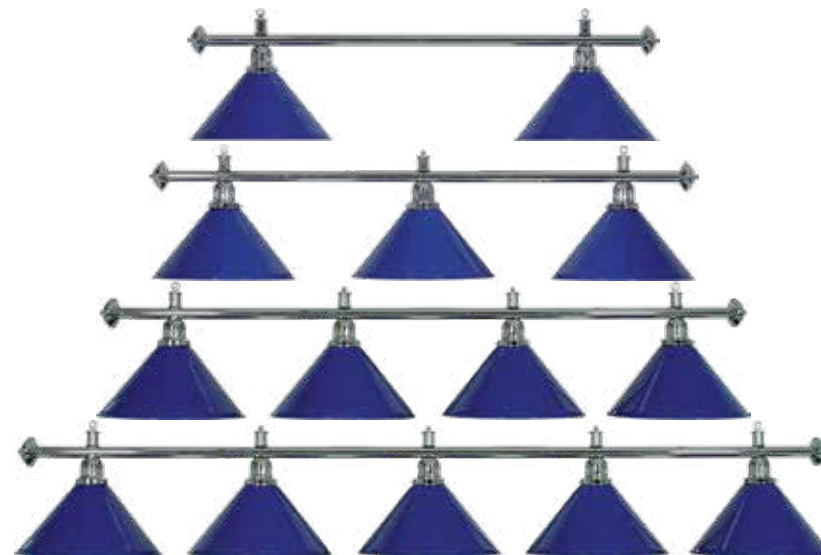

SHADE COLOURS / COLORI CAMPANA

MOONLIGHT MADE IN ITALY





NORMAL LIGHT / LUCE NORMALE 			
2	3	4	5
10347	10348	10349	10386

SHADE COLOURS / COLORI CAMPANA

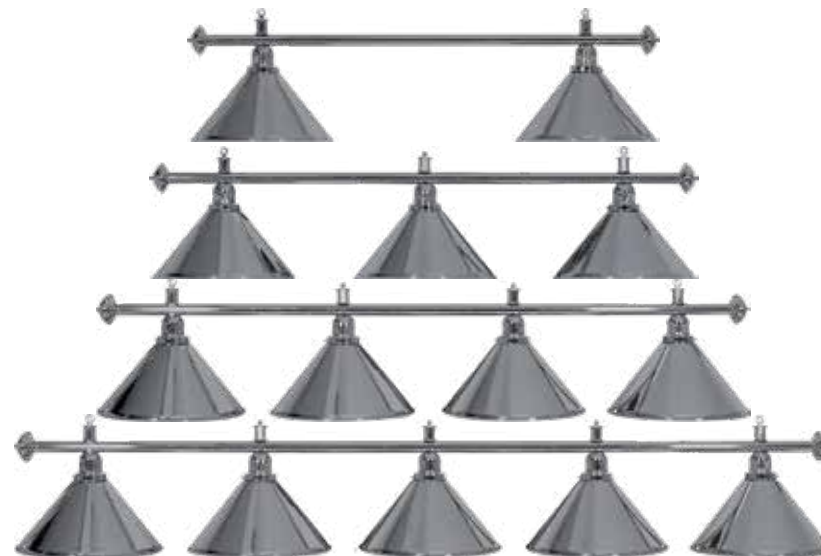

ROD COLOURS / COLORI ASTA



NORMAL LIGHT / LUCE NORMALE 			
2	3	4	5
10356	10357	10358	10384

SHADE COLOURS / COLORI CAMPANA



ROD COLOURS / COLORI ASTA



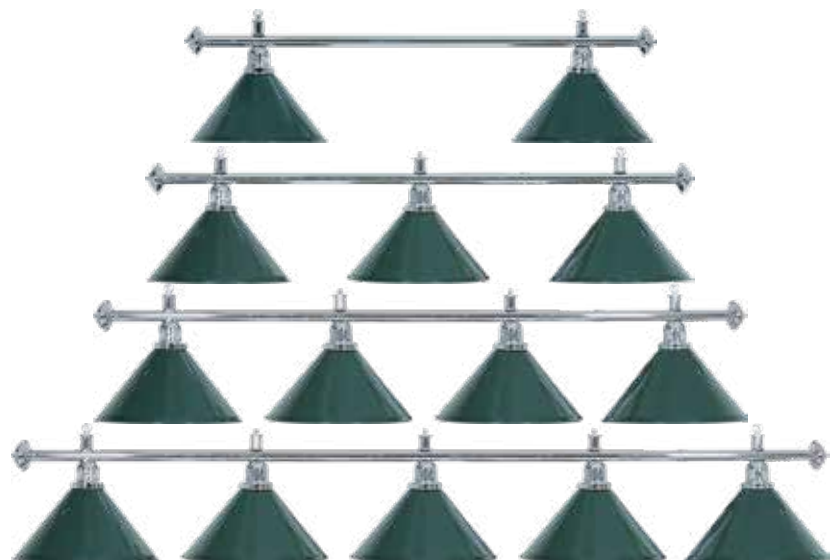

NORMAL LIGHT / LUCE NORMALE 			
2	3	4	5
10350	10351	10372	10385

SHADE COLOURS / COLORI CAMPANA 

ROD COLOURS / COLORI ASTA 



NORMAL LIGHT / LUCE NORMALE 				
10364	10365	10366	10367	10368



10363	10359	10360	10362	10361
-------	-------	-------	-------	-------



ART. 10041

CHROMIUM-PLATED CHAIN FOR STANDARD LAMPS, SUPPLIED BY THE METER
CATENA CROMATA PER LAMPADARI, VENDUTA AL METRO

ART. 10041O

GOLDEN CHAIN FOR STANDARD LAMPS, SUPPLIED BY THE METER
CATENA PER LAMPADARI ORO, VENDUTA AL METRO

ART. 10041B

BLACK CHAIN FOR STANDARD LAMPS, SUPPLIED BY THE METER
CATENA PER LAMPADARI NERA, VENDUTA AL METRO



ART. 300094

CHROMIUM-PLATED DISH

PIATTELLO CROMATO

ART. 10076

BLACK DISH

PIATTELLO NERO



ART. 300258

CHROMIUM-PLATED TIGET

TIGETTA CROMATA

ART. 300258O

BRASS TIGET

TIGETTA OTTONE

ART. 300258N

BLACK TIGET

TIGETTA NERA



ART. 300084

COMPLETE LATCH WITH NORMAL LIGHT

SALISCENDI COMPLETO CON LUCE NORMALE



ART. 300095

LAMP-HOLDER

PORTALAMPADA



ART. 10051

REACTOR - HOLDER

PORTA REATTORE



ART. 10042

CIRCULAR NEONTUBE ICE COLOUR 32 W

CIRCOLINA 32 W LUCE BIANCO GHIACCIO



ART. 10049

PLATE FOR NEONTUBE HOLDER

PIATTO PORTACIRCOLINA



ART. 10060

CIRCOLUX EL 24W/827 E27

CIRCOLUX EL 24W/827 E27



REACTOR / REATTORE TRADIZIONALE

WATT	32 W	40 W	65 W
ART.	10044	302109	302110



ART. 10043
WIRE STARTER-HOLDER
PORTASTARTER A FILO

TRADITIONAL LAMPS
LAMPADARIO TRADIZIONALE



90 cm
SUGGESTED LAMP HEIGHT
ALTEZZA SUGGERITA PER LAMPADARIO



ART. 10046
STARTER / STARTER

TECHNICAL DETAILS LAMPS / TABELLA DATI TECNICI LAMPADARI

LAMPS REFERENCE TABLE / TABELLA TECNICA							
MODEL MODELLO	LIGHT LUCE	ROD LENGHT LUNGH. ASTA	HEIGHT SHADE ALTEZ. CAMPANA	WIDTH SHADE LARGH. CAMPANA	DIST. BETWEEN CHAINS INTERASSE	SHADE MATERIAL MATERIALE CAMPANA	ROD MATERIAL MATERIALE ASTA
AMSTERDAM	1	-	25	33	-	POLYSTYRENE POLISTIRENE	-
MILANO	1	-	30	35	-	POLYSTYRENE POLISTIRENE	-
MILANO	2	130	44	35	45		ALUMINIUM ALLUMINIO
MILANO	3	185	44	35	88		
MILANO	4	211	44	35	103		
MILANO	5	230	44	35	134		
MILANO	6	320	44	35	190		
MOONLIGHT	1	-	20	39	-	FERRO / IRON	-
	2	135	20	39	90	FERRO / IRON	IRON
	3	155	20	39	110	FERRO / IRON	IRON
	4	185	20	39	140	FERRO / IRON	IRON
	5	251	20	39	210	FERRO / IRON	IRON
PARIGI	1	-	19	35	-	POLYSTYRENE POLISTIRENE	-
PARIGI	2	130	36	35	45		ALUMINIUM ALLUMINIO
PARIGI	3	185	36	35	88		
PARIGI	4	211	36	35	103		
PARIGI	5	230	36	35	134		

NAUTILUS COMPACT



The professional lamp
Made in Italy

NAUTILUS

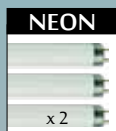
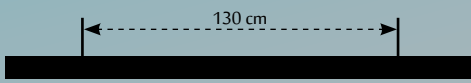

90 cm SUGGESTED HEIGHT FOR NEON LAMP
90 cm ALTEZZA SUGGERITA PER LAMPADARIO AL NEON

ART	LAMP SIZES MISURE	WEIGHT PESO	LIGHT LUCE	N. NEON/LED	BALLAST REATTORE	WATT POWER M. POTENZA WATT M.	VOLTS/HZ
10376	205 X 31 X 6 cm	11,30 kg	NEON T8	4 X 30 W	ELECTRONIC	144 W	220/50
10377	247 X 31 X 6 cm	15,65 kg	NEON T8	4 X 36 W	ELECTRONIC	173 W	220/50
10378	287 X 31 X 6 cm	17 kg	NEON T8	2 X 36 W 2 X 58 W	ELECTRONIC	226 W	220/50
10379	320 X 31 X 6 cm	18,6 kg	NEON T8	6 X 58 W	ELECTRONIC	420 W	220/50

PACKAGING SIZE MISURE IMBALLO	PACKAGING WEIGHT PESO IMBALLO	SUGGESTED FOR CONSIGLIATO PER
223 X 11 X 43 cm	15 kg	POOL & CAROM 7' (198 X 99 cm) 8' (224 X 112 cm)
265 X 11 X 43 cm	19 kg	POOL & CAROM 9' (254 X 127 cm)
304 X 11 X 43 cm	21 kg	GRAND MATCH CAROM & 5 BIRILLI 10' (284 X 142 cm)
337 X 11 X 43 cm	22,2 kg	RUSSIAN PYRAMID & SNOOKER

NAUTILUS *Led*

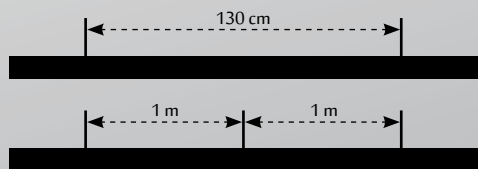
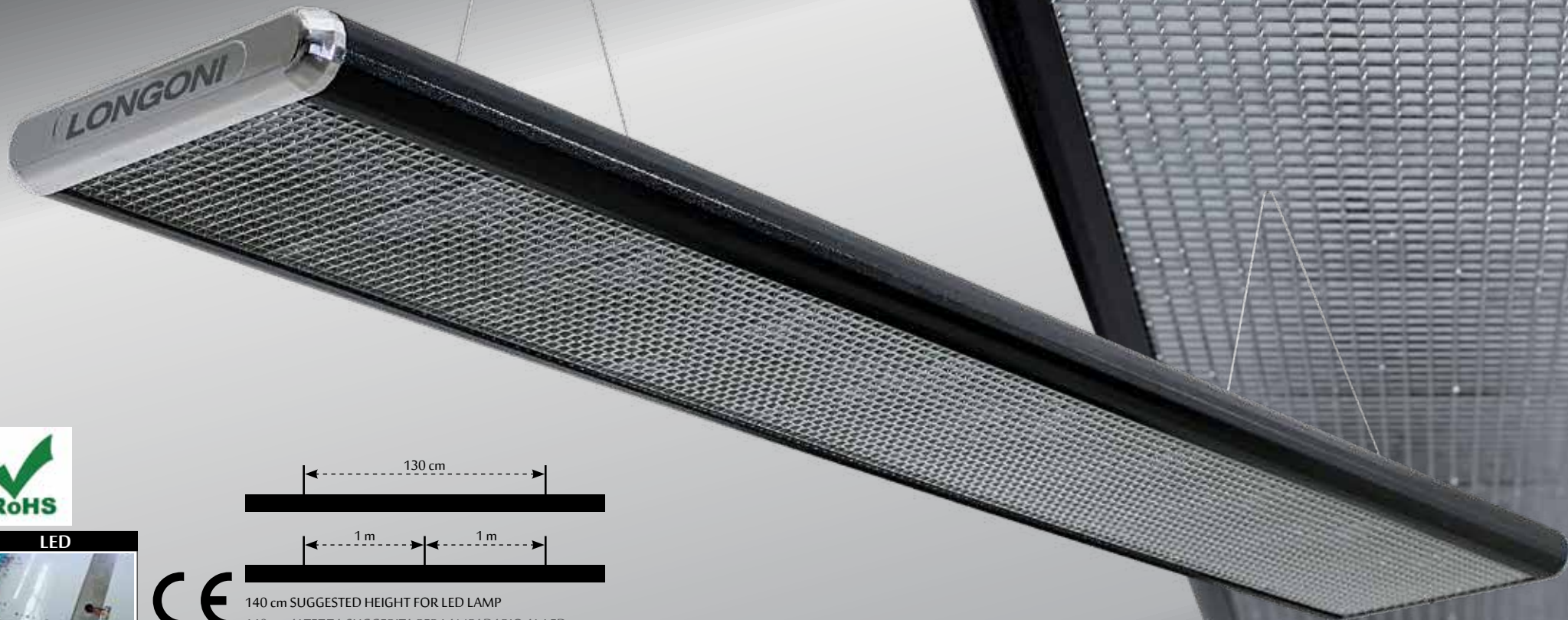

140 cm SUGGESTED HEIGHT FOR LED LAMP
140 cm ALTEZZA SUGGERITA PER LAMPADARIO AL LED

ART	LAMP SIZES MISURE	WEIGHT PESO	LIGHT LUCE	LED	WATT POWER M. POTENZA WATT M.	VOLTS/HZ
10297	205 X 31 X 6 cm	10,9 kg	LED*	200	65 W	110-230/50-60
10298	247 X 31 X 6 cm	15,65 kg	LED*	300	98 W	110-230/50-60
10299	287 X 31 X 6 cm	16,6 kg	LED*	350	114 W	110-230/50-60
10300	320 X 31 X 6 cm	19,3 kg	LED*	400	130 W	110-230/50-60

LUX ON THE PLAYFIELD LUX SUL PIANO	PACKAGING SIZE MISURE IMBALLO	PACKAGING WEIGHT PESO IMBALLO	SUGGESTED FOR CONSIGLIATO PER
550	223 X 11 X 43 cm	14,7 kg	POOL & CAROM 7' (198 X 99 cm) 8' (224 X 112 cm)
550	265 X 11 X 43 cm	18,7 kg	POOL & CAROM 9' (254 X 127 cm)
550	304 X 11 X 43 cm	20 kg	GRAND MATCH CAROM & 5 BIRILLI 10' (284 X 142 cm)
550	337 X 11 X 43 cm	22,5 kg	RUSSIAN PYRAMID & SNOOKER

* TESTED ON A POOL TABLE WITH A LED LAMP AT 140 CM FROM SLATE - BASATO SU UN POOL CON LAMPADA A 140 CM DAL PIANO.
COLOUR'S TEMPERATURE OF THE LIGHT : 4.000 K - TEMPERATURA DI COLORE DELLA LUCE: 4000 K

COMPACT

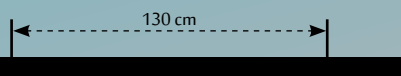
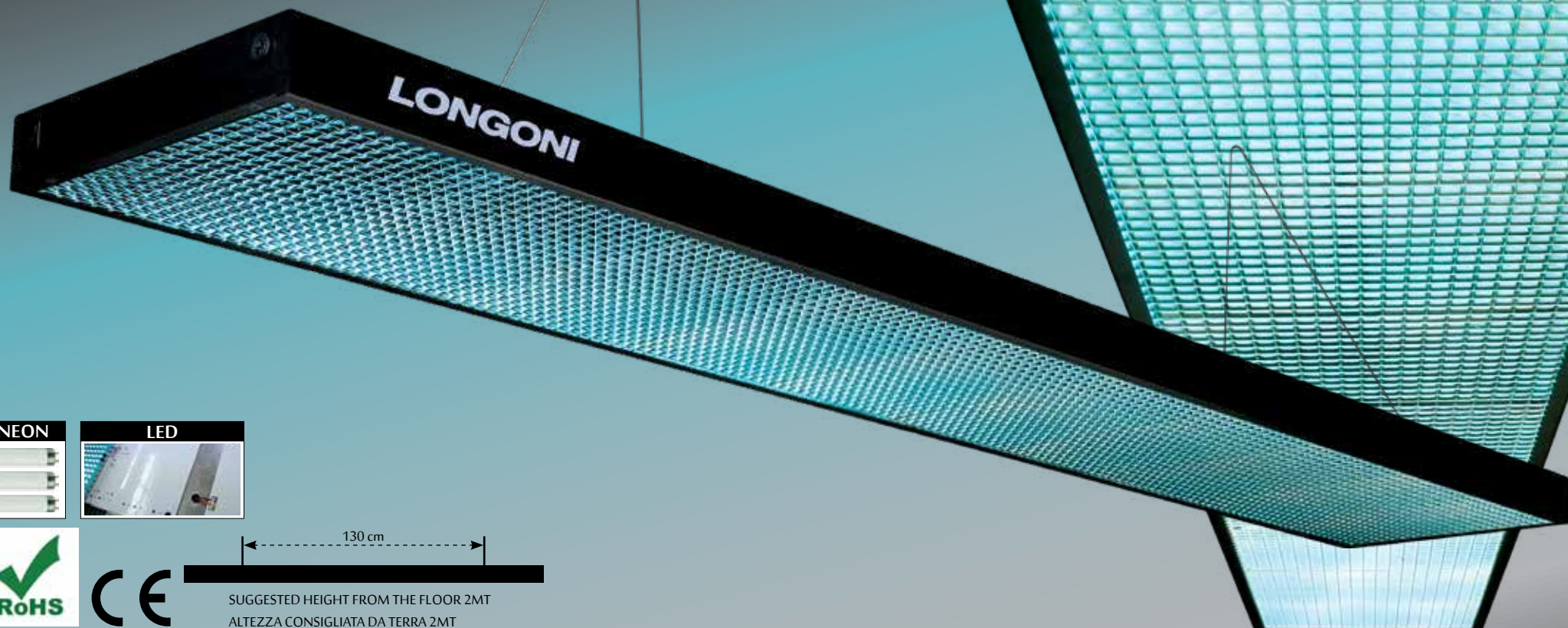

SUGGESTED HEIGHT FROM THE FLOOR 2MT
ALTEZZA CONSIGLIATA DA TERRA 2MT

ART	LAMP SIZES MISURE	WEIGHT PESO	LIGHT LUCE	N. NEON/LED	REACTOR REATTORE	WATT POWER M. POTENZA WATT M.	VOLTS/HZ
10194	205 X 31 X 6 cm	13,70 kg	NEON	4 X 32 W	MECHANIC	136 W	220/50
10193	247 X 31 X 6 cm	15,80 kg	NEON	4 X 36 W	MECHANIC	149 W	220/50
10192	287 X 31 X 6 cm	18,45 kg	NEON	2 X 36 W 2 X 58 W	MECHANIC	188 W*	220/50
10290	205 X 31 X 6 cm	11,3 kg	LED*	200	-	64 W	110-230/50-60
10291	247 X 31 X 6 cm	13,4 kg	LED*	300	-	77W	110-230/50-60
10292	287 X 31 X 6 cm	15,15 kg	LED*	350	-	102 W*	110-230/50-60

* 5500 LUMEN CR/80 - 4000° K (NATURAL WHITE / BIANCO NATURALE)

PACKAGING SIZE MISURE IMBALLO	PACKAGING WEIGHT PESO IMBALLO	SUGGESTED FOR CONSIGLIATO PER
223 X 11 X 38 cm	16,7 kg	POOL & CAROM 7' (198 X 99 cm) - 8' (224 X 112 cm)
264 X 11 X 28 cm	19 kg	POOL & CAROM 9' (254 X 127 cm)
303 X 11 X 38 cm	22 kg	GRAND MATCH CAROM & 5 BIRILLI 10' (284 X 142 cm)
223 X 11 X 38 cm	14,3 kg	POOL & CAROM 7' (198 X 99 cm) - 8' (224 X 112 cm)
264 X 11 X 28 cm	16,6 kg	POOL & CAROM 9' (254 X 127 cm)
303 X 11 X 38 cm	18,7 kg	GRAND MATCH CAROM & 5 BIRILLI 10' (284 X 142 cm)

COMPACT

FOR RUSSIAN PYRAMID & SNOOKER

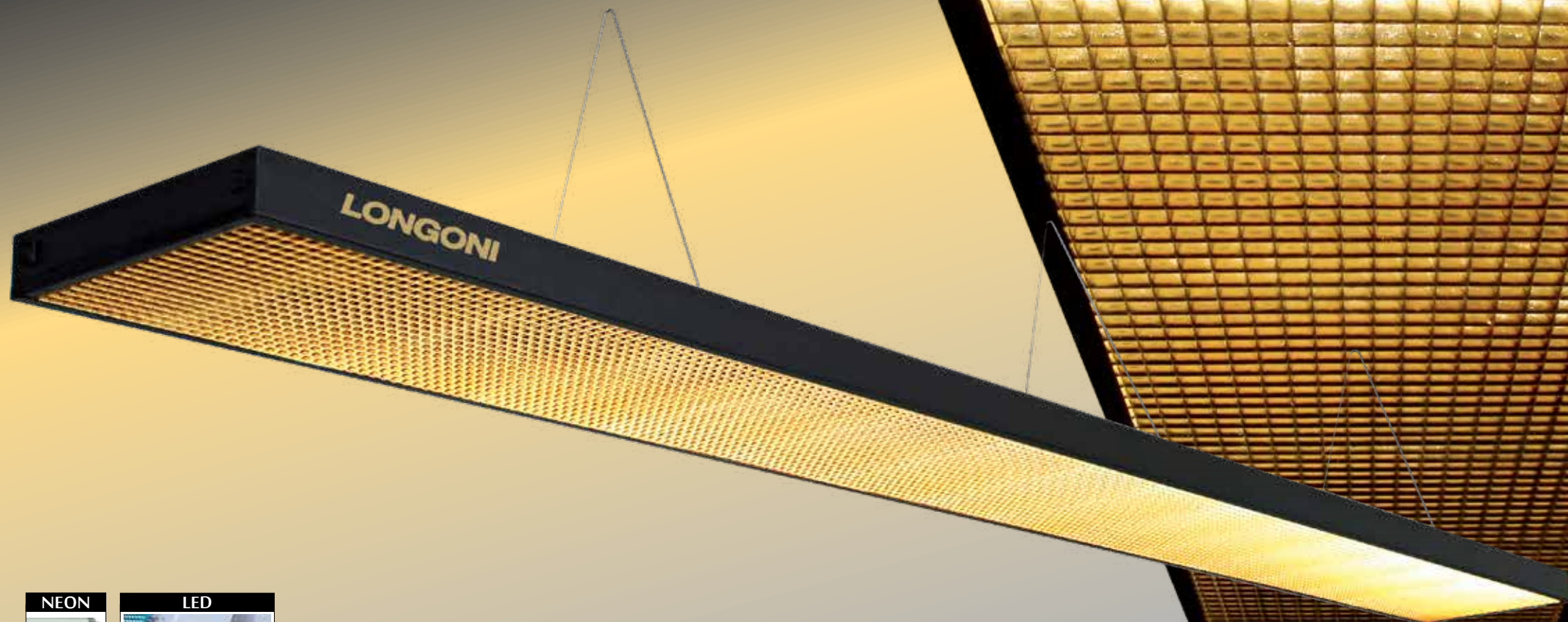

SUGGESTED HEIGHT FROM THE FLOOR 2MT
ALTEZZA CONSIGLIATA DA TERRA 2MT

ART	LAMP SIZES MISURE	WEIGHT PESO	LIGHT LUCE	N. NEON/LED	REACTOR REATTORE	WATT POWER M. POTENZA WATT M.	VOLTS/HZ
10293	320 X 31 X 6 cm	18,2 kg	NEON	6 x 58 W	ELECTRONIC	325 W	220/50
10295	320 X 31 X 6 cm	17,6 kg	LED*	400	-	116 W*	110-230/50-60

* 5500 LUMEN CR/80 - 4000° K (NATURAL WHITE / BIANCO NATURALE)

PACKAGING SIZE MISURE IMBALLO	PACKAGING WEIGHT PESO IMBALLO	SUGGESTED FOR CONSIGLIATO PER
339 X 35 X 9 cm	22,50 kg	RUSSIAN PYRAMID & SNOOKER
339 X 35 X 9 cm	21,9 kg	RUSSIAN PYRAMID & SNOOKER

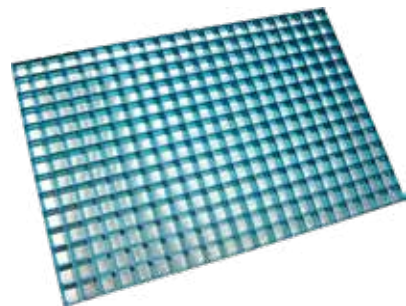

ART. 302118
COMPACT PROTECTION GRID (305 X 205 X 8 mm)
GRIGLIA AZZURRA PER LAMPADARIO COMPACT
(305 X 205 X 8 mm)

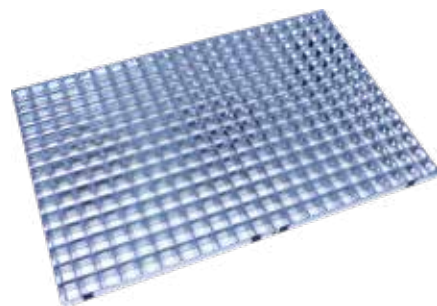

ART. 302118C
COMPACT PROTECTION GRID (305 X 205 X 8 mm)
GRIGLIA CROMO PER LAMPADARIO COMPACT
(305 X 205 X 8 mm)

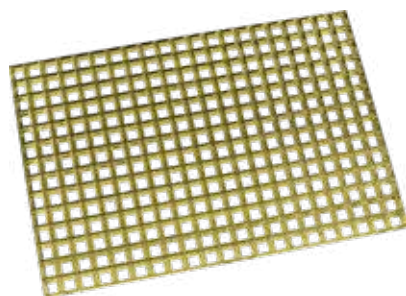

ART. 302118O
COMPACT PROTECTION GRID (305 X 205 X 8 mm)
GRIGLIA ORO PER LAMPADARIO COMPACT
(305 X 205 X 8 mm)



NEON T8 LIGHT FOR COMPACT
LAMPADA NEON T8 PER COMPACT

	30 W	36 W	58 W
ART.	302122	302116	302117
cm	90	120	150

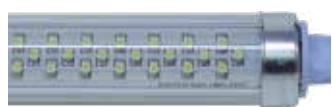

LIGHT LED FOR COMPACT
LAMPADA LED PER COMPACT

ART.	302160	302159	302161
cm	90	120	150



ART. 302114
345/ MAU LAMP-HOLDER
PORTALAMPADE 345/MAU



ART. 302115
346/ MAU LAMP-HOLDER
PORTALAMPADE 346/MAU



ART. F843
LONGONI BLACK PLASTIC CAP NAUTILUS LAMP
TAPPO PLASTICA NERO LONGONI PER LAMPADARIO
NAUTILUS



ART. F843C
LONGONI CHROMED PLASTIC CAP NAUTILUS LAMP
TAPPO PLASTICA CROMOTO LONGONI PER
LAMPADARIO NAUTILUS



MAGNETIC BALLAST 220 V
REATTORE MAGNETICO 220 V

	32 W	40 W	65 W
ART.	10044	302109	302110



ELECTRONIC BALLAST 220 V
REATTORE ELETTRONICO 220 V

	30W 220V	36 W 220V	58 W 220V
ART.	302169	302168	312167



ART. 302119
CAPACITOR 5yF
CONDENSATORE DA 5 yF



ART. 10046
STARTER



ART. 302103
SWITCH
INTERRUTTORE



ART. 302113
CONNECTING-ROSE FOR
STEEL CABLE
ROSONE PER FUNE D'ACCIAIO



ART. 302128
FUSE 8A FOR RECTANGULAR LAMP
FUSIBILE 8A PER LAMPADARIO
RETTANGOLARE



ART. 18252
TERMINAL FOR BIG WIRE
MORSETTO PER FUNE GRANDE



ART. 302111
TERMINAL FOR SMALL STEEL WIRE
MORSETTO PER FUNE D'ACCIAIO
PICCOLO



ART. 302105
FUSE HOLDER FEC
PORTAFUSIBILE FEC

ART. 302112
STEEL CABLE FOR RECTANGULAR LAMP
FUNE D'ACCIAIO PER LAMPADARIO RETTANGOLARE



ART. 300551
LED PLATE FOR COMPACT NAUTILUS LAMP
PIASTRA LED PER LAMPADARIO COMPACT NAUTILUS

- POWERFUL AND UNIFORM LIGHT ON THE TABLE
- NEON LIGHTS / LED WITH PROTECTION GRIDS
- EASY MAINTENANCE
- ITALIAN MODERN DESIGN

THE COMPACT LIGHT IS THE PERFECT LIGHTING SYSTEM FOR ALL POOL ROOMS AND THE MOST SUGGESTED ONE FOR TOURNAMENTS. THE SPECIAL DESIGNED CONE OF LIGHT ENSURES AN EQUAL LIGHTING ON THE WHOLE PLAYFIELD WITHOUT CREATING ANY SHADOWS OR DARKER AREA. DUE TO A GRID INSERT, PLAYERS EYES WILL NOT BE DAZZLED, ALLOWING A CONCENTRATED AND UNDISTURBED GAME. FEATURES: CASING IN BLACK LACQUERED METAL OVEN VARNISHED, NEON LIGHT TUBES OR LED, CHROMED PLASTIC GRID, HANGING UP CABLE INCLUDED, CE AND ROHS APPROVED.

- LUCE POTENTE ED UNIFORME SUL BILIARDO
- ILLUMINAZIONE AL NEON O LED CON GRIGLIE DI PROTEZIONE
- FACILE MANUTENZIONE
- MODERNO DESIGN ITALIANO

IL LAMPADARIO COMPACT È IL SISTEMA DI ILLUMINAZIONE PERFETTO PER TUTTE LE SALE DA GIOCO E SPECIALMENTE PER L'UTILIZZO IN EVENTI AGONISTICI. LA SPECIALE DISPOSIZIONE DELLE LUCI GARANTISCE UN'ILLUMINAZIONE OMOGENEA SU TUTTO IL CAMPO GIOCO SENZA CREARE ZONE D'OMBRA. GRAZIE AD UNA SPECIALE GRIGLIA GLI OCCHI DEI GIOCATORI NON SARANNO MAI ACCECATI DALLA LUCE. CARATTERISTICHE: STRUTTURA IN FERRO VERNICIATO A FORNO, DISPONIBILE NELL'ILLUMINAZIONE AL NEON O LED, GRIGLIA IN PLASTICA CROMATA, CAVI PER FISSAGGIO INCLUSI, CERTIFICATO CE E ROHS.

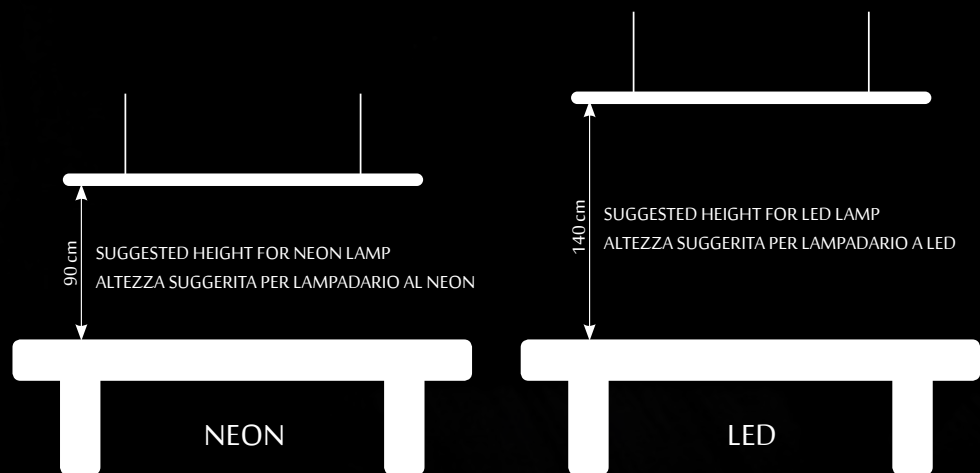

Billiard accessories
Accessori biliardo

 **aramith**® *Aramith, the signature of true Belgian Quality.*

A LEGEND IN THE BILLIARD WORLD

For several decades Belgian Aramith Billiard balls have enjoyed a legendary reputation for outstanding endurance and uncompromised quality. Used by almost 80% of players worldwide, they are recognised as the reference of the industry. Made by Saluc in Belgium, Aramith excellence is the result of a high-tech process that combines the unmatched characteristics of phenolic resin with fine Belgian craftsmanship. Their consistently reliable performance guarantees players the pleasure of razor-sharp precision. Their exceptionally long product life offers the table owner the lowest ball cost on an annual basis. That is how Aramith for almost half a century gained its legendary reputation as signature for true and unrivalled quality.

NOT JUST A SMART BUY BUT A WISE INVESTMENT

A QUALITY INVESTMENT. Perfectly round and balanced - uniform weight and hardness - brilliant colours - friction resistant roll and reaction - are just a few of the key features that have earned Aramith its worldwide reputation as the premiere ball. Aramith balls are internationally approved for tournaments and championships.

A LIFETIME INVESTMENT. Aramith phenolic balls last up to 5 times longer than other balls made from polymers or polyester. The billiard-play simulator leaves no doubt : Aramith phenolic balls are still perfectly playable even after 400.000 hits, whereas others were rendered unusable. No wonder they are the logical choice for commercial and private table-owners.

ARAMITH PHENOLIC RESIN: WHY IT MAKES THE DIFFERENCE!

HEAVY DUTY DESIGN. Rather than a polyester number-plug-design, the Aramith concept has the numbers precision-engraved in a solid core that runs all the way through the ball. As such, it is impossible for number-cores to fall out over time. Using phenolic resin assures homogeneous characteristics in each ball part. So homogeneous that when finally getting to its breaking point (and one needs minimum a 5 ton-load in case of an Aramith ball), the ball will break up totally at random, and not along the parting line between the stripe and the rest of the ball, as one would expect.

BURN-SPOT RESISTANT. Hitting a cue ball actually accelerates it from 0 to over 30 km/h (20 MPH) in just a fraction of a second. The resulting friction temperature between ball and cloth can easily reach 250°C (482°F). That's why Aramith balls are the only ones made from genuine phenolic resin : their molecular structure is engineered to be wear resistant at these high temperatures, making Aramith balls far less vulnerable to abrasive burn-spots. They hold their high luster and smoothness over a much longer period of time, resulting in minimal ball and table cloth wear.

HIGH IMPACT RESISTANCE. Because hitting the balls is the essence of the billiard game, impact resistance is a critical factor. Aramith's phenolic heat-curing process fully stabilizes material tensions. It produces a vitrified high-density surface that offers maximum impact resistance. Tests show Aramith phenolic balls to withstand to over 50 times more impacts than other polymer or polyester balls. They are also twice more scratch-resistant. Consequently, when intensively used even on less maintained tables, Aramith balls are clearly far less easily da-maged than others by pocket fixings, table mechanisms or cue sticks.

ARAMITH PHENOLIC RESIN: DESIGNED FOR HIGH PRECISION PLAY

PERFECT REBOUND. Far more important than ball tolerances are the balls rebound capacities. Only predictable rebounds allow strategic repositioning of the cue ball to optimize the following shot. The unique elasticity of the phenolic Aramith resin has been calibrated to offer the optimal level of rebound to allow players to fully control the effect of every shot.

 **aramith**® *la firma della vera qualità belga.*

UNA LEGGENDA NEL MONDO DEL BILIARDO.

Da diversi decenni, le bilie Aramith godono di una leggendaria reputazione basata sulla loro eccezionale resistenza e qualità. Usate da quasi l'80% dei giocatori di tutto il mondo, esse sono considerate come "LA" referenza del settore. L'eccellenza delle bilie Aramith, fabbricate in Belgio, è il risultato di un processo tecnologicamente avanzato; quest'ultimo combina le caratteristiche uniche della resina fenolica con la riconosciuta perizia della manodopera belga. La loro estrema affidabilità, sinonimo di performance elevatissime, garantisce un gioco assolutamente preciso. La loro durata di vita, eccezionalmente lunga, si traduce per i proprietari dei tavoli da biliardo in costi annuali ridotti al minimo. Ecco perché Aramith beneficia da quasi mezzo secolo di una reputazione leggendaria, basata su una qualità verace e senza pari.

NON SOLTANTO UN BUON ACQUISTO, MA UN SAGGIO INVESTIMENTO.

UN INVESTIMENTO DI QUALITÀ. Perfettamente sferiche ed equilibrate - peso e durezza uniformi - colori brillanti - rotazione massima ed attrito minimo - sono solo alcune delle caratteristiche qualitative che hanno consentito alle bilie Aramith di conquistare la reputazione di leader del mercato. Le bilie Aramith sono in generale approvate per vari tornei e campionati internazionali.

UN INVESTIMENTO DI DURATA ECCEZIONALE. Le bilie fenoliche Aramith durano sino a 5 volte più delle altre bilie fabbricate con polimeri o poliestere. Anche il simulatore di gioco del biliardo non lascia alcun dubbio: le bilie fenoliche Aramith consentono di giocare normalmente anche dopo 400.000 colpi, laddove le altre bilie non sarebbero più utilizzabili. Nessuno quindi si meraviglierà del perché queste bilie siano la scelta logica dei proprietari di biliardi nei circoli pubblici e nelle abitazioni private.

RESINA FENOLICA ARAMITH: LA VERA DIFFERENZA.

DESIGN ESTREMAMENTE RESISTENTE. Al posto del design della bilia in poliestere in cui il numero è impresso a tampone, il concetto Aramith prevede l'incisione precisa del numero in un nucleo solido che attraversa la bilia da parte a parte. In questo modo, il numero sarà presente in modo permanente. L'impiego di resina fenolica assicura caratteristiche di omogeneità in ciascuna sezione della bilia. Un'omogeneità tale che, una volta raggiunto il suo punto di rottura (e per questo deve essere sottoposta ad una pressione di 5 tonnellate), questa bilia si romperà completamente in un punto a caso, e non lungo la linea di separazione fra la striscia e la sua parte restante, come ci si potrebbe aspettare.

RESISTENTI AI PUNTI DI BRUCIATURA. Colpire un pallino significa imprimergli un'accelerazione da 0 a più di 30 km/h in una frazione di secondo. La temperatura risultante dell'attrito fra la bilia e il panno può facilmente raggiungere i 250°C. Questa è la ragione per cui le bilie Aramith sono le sole fabbricate con resina fenolica naturale: la loro struttura molecolare, sottoposta a temperatura elevata, è in grado di resistere all'usura e di garantire una migliore vulnerabilità ai punti di bruciatura abrasivi. Esse conservano la loro lucentezza e levigatezza su un periodo di tempo molto più lungo, con un'usura minima della bilia stessa e del panno.

ELEVATA RESISTENZA ALL'IMPATTO. Poiché il gioco del biliardo è centrato essenzialmente sull'abilità di colpire la bilia, la resistenza all'impatto è un fattore essenziale. Il processo di indurimento a caldo della resina fenolica Aramith consente una stabilizzazione completa delle tensioni del materiale. Esso dà come risultato una superficie vetrificata ad alta densità, in grado di offrire la massima resistenza all'impatto. Prove effettuate in laboratorio hanno evidenziato la capacità delle bilie fenoliche Aramith di sopportare un impatto di 50 volte superiore a quello delle bilie fabbricate con polimeri o poliestere. Esse possiedono inoltre una doppia resistenza alle scalfiture rispetto alle altre. Di conseguenza, anche se usate su biliardi non sottoposti a regolare manutenzione, le bile Aramith subiscono chiaramente molto meno danni causati dalle borchie delle tasche dei giocatori, dai meccanismi del tavolo e dalle stecche.

RESINA FENOLICA ARAMITH: SVILUPPATA PER UN GIOCO DI ESTREMA PRECISIONE

UN RIMBALZO PERFETTO. Più importanti delle tolleranze della bilia, sono le capacità di rimbalzo della stessa. Solo i rimbalzi prevedibili consentono un riposizionamento del pallino per il colpo successivo. L'eccezionale elasticità della resina fenolica Aramith è stata calibrata allo scopo di offrire un livello ottimale di rimbalzo, in modo da consentire ai giocatori gli effetti di ciascun colpo.

POOL SETS / BILIE PER POOL

STANDARD SIZE / MISURA STANDARD Ø 57,2 mm



art. 2251
SUPER ARAMITH PRO TV 57,2 mm



art. 2120
SUPER ARAMITH PRO 57,2 mm



art. 2242
ARAMITH PREMIUM 57,2 mm



art. 2050
ARAMITH PREMIER 57,2 mm
art. 2182
ARAMITH PREMIER 57,2 mm (no cue ball/senza pallino)



art. 2530
DURAMITH PRO 57,2 mm



art. 2531
DURAMITH PRO CUP TV 57,2 mm

SPECIAL POOL SET / SET DA POOL SPECIALI



art. 2384
CAMOUFLAGE COLLECTION Ø 57,2 mm



art. 2227
FLUO SET Ø 57,2 mm

COIN-OP HOME POOL SETS/BILIE PER TAVOLI A GETTONIERA O USO DOMESTICO

STANDARD SIZE / MISURA STANDARD Ø 57,2 mm



STANDARD
art. 2056 - Ø 54 mm
art. 2057 - Ø 52,4 mm
art. 2087 - Ø 57,2 mm (cue ball/pallino Ø 60,3 mm)
art. 2078 - Ø 57,2 mm (cue ball/pallino Ø 54 mm)
art. 2183 - Ø 57,2 mm (no cue ball/senza pallino)
art. 2051 - Ø 57,2 mm (regular cue ball/pallino regolare)



CONTINENTAL
art. 2044 - Ø 35 mm
art. 2077 - Ø 38 mm
art. 2041 - Ø 48 mm
art. 2144 - Ø 57,2 mm



art. 2211 - Ø 57,2 mm
NEW ECONOMIC

CAROM, 5 BIRILLI SETS

STANDARD SIZE / MISURA STANDARD Ø 61,5 mm



SUPER ARAMITH
art. 2042 - Ø 61,5 mm



SUPER ARAMITH PRO CUP
art. 2253 - Ø 61,5 mm



SUPER ARAMITH DE LUXE
art. 2071 - Ø 61,5 mm



ARAMITH PREMIERE
art. 2289 - Ø 61,5 mm



ARAMITH 4 BILIE
art. 2210 - Ø 61,5 mm



SUPER ARAMITH PRO-CUP
art. 2779 - Ø 61,5 mm



SUPER ARAMITH TOURNAMENT
art. 2778 - Ø 61,5 mm



SUPER ARAMITH TOURNAMENT
(not homologated / non omologate)
art. 2049 - Ø 61,5 mm
art. 2280 - Ø 60,3 mm

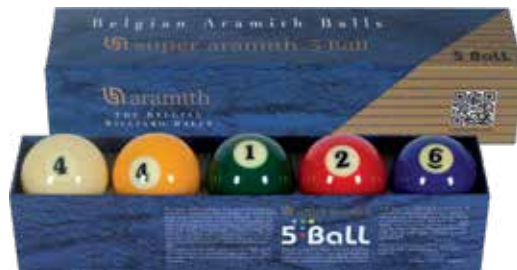

SUPER ARAMITH 5 BALL
art. 2529 - Ø 61,7 mm



BILIE OMOLOGATE Ø 61,5 mm PER 5 BIRILLI



SUPER ARAMITH
PRESTIGE PRO-CUP
art. 2401 - Ø 61,5 mm



SUPER ARAMITH
TOURNAMENT
art. 2297 - Ø 61,5 mm

Original seal on each box / Prodotto certificato su ogni scatola



SNOOKER SETS / BILIE DA SNOOKER

STANDARD SIZE / MISURA STANDARD Ø 52,4 mm



ARAMITH - set 22 balls/bilie
art. 2058 - Ø 52,4 mm
art. 2155 - Ø 57,2 mm



SNOOKER TOURNAMENT
set 22 balls/bilie
art. 2082 - Ø 52,4 mm



ARAMITH - set 17 balls/bilie
art. 2083 - Ø 38 mm
art. 2257 - Ø 41,3 mm
art. 2193 - Ø 48 mm



TOURNAMENT CHAMPION 1G
set 22 balls/bilie
art. 2780 - Ø 52,4 mm

PYRAMID SETS

STANDARD SIZE / MISURA STANDARD



SUPER ARAMITH PRO TOURNAMENT
art. 2256 - Ø 67 mm



PREMIER
art. 2278 - Ø 60,3 mm
art. 2220 - Ø 68 mm

BOCLETTE SETS

STANDARD SIZE / MISURA STANDARD Ø 59 mm



SUPER ARAMITH
art. 2038 - Ø 59 mm
art. 2150 - Ø 61,5 mm

FUNGHETTO SETS

STANDARD SIZE / MISURA STANDARD Ø 48 mm



SUPER ARAMITH
art. 2080 - Ø 48 mm
art. 2054 - Ø 61,5 mm

CASINO SET/POOL ANGLAIS

STANDARD SIZE / MISURA STANDARD Ø 50,8 mm



ARAMITH
art. 2197 - Ø 50,8 mm
art. 2085 - Ø 57,2 mm



art. 2240
CASINO BALLS FLUO SET 57,2 mm
+ W.B. 60,3 mm
BILIE SET CASINO FLUORESCENTI
57,2 mm + PALLINO 60,3 mm

ITALIANA SETS

STANDARD SIZE / MISURA STANDARD Ø 68 mm



art. 2011
SUPER ARAMITH



art. 2013
SUPER ARAMITH WITH DOT / CON PUNTINO

STANDARD LOOSE BALLS / BILIE STANDARD SFUSE

STANDARD SIZE / MISURA STANDARD Ø 57.2 mm

BRILLIANT COLOURS, MAXIMUM ROTATION, MINIMUM FRICTION, PERFECT REBOUND
COLORI BRILLANTI, ROTAZIONE MASSIMA, ATTRITO MINIMO, LIVELLO OTTIMALE DEL RIMBALZO

NATURAL PHENOLIC
RESIN BALLS
BILIE IN RESINA
FENOLICA NATURALE



THE NUMBER IS PERFECTLY ENGRAVED IN A SOLID CORE THAT RUNS ALL THE WAY THROUGH THE BALL
INCISIONE PRECISA DEL NUMERO IN UN NUCLEO SOLIDO CHE ATTRAVERSA LA BILIA DA PARTE A PARTE



205501	205502	205503	205504	205505	205506
--------	--------	--------	--------	--------	--------



205507	205508	205509	205510	205511	205512
--------	--------	--------	--------	--------	--------



205513	205514	205515
--------	--------	--------

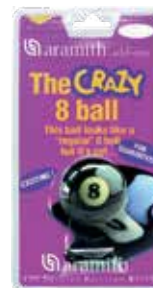

art. 2270
CRAZY N.8
Ø 57,2 mm



art. 2266
GOLDEN N.8
Ø 57,2 mm



art. 2279
ARAMITH PRO TV
Ø 57,2 mm



art. 2264
J.REMPE POOL TRAINING
Ø 57 mm



art. 2228
Q-TRU TRAINING
Ø 57,2 mm



art. 300018
SUPER ARAMITH PRO
Ø 57,2 mm

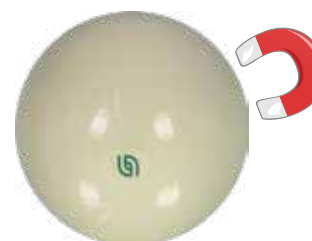

art. 2115T
CUE BALL ARAMITH
TOURNAMENT MAGNETIC 57,2
mm WHITE
PALLINO MAGNETICO ARAMITH
TOURNAMENT 57,2 mm BIANCO



art. 2115
ARAMITH MAGNETIC Ø 57,2 mm
PALLINO MAGNETICO Ø 57,2 mm



WHITE CRAZY S. ARAMITH
BILIA PAZZA BIANCA
art. 2148 - Ø 57,2 mm
art. 2158 - Ø 61,5 mm

**LOOSE PLAIN COLOUR BALLS
BILIE SFUSE TINTA UNITA**



ARAMITH	
Art. 2103	Ø 38 mm
Art. 2281	Ø 47,6 mm
Art. 300014	Ø 48 mm
Art. 2023	Ø 50,8 mm
Art. 2024	Ø 52,4 mm
Art. 2025	Ø 54 mm
Art. 2020	Ø 57,2 mm
Art. 2021	Ø 59 mm
Art. 2026	Ø 60,3 mm
Art. 2204	Ø 61,5 mm
Art. 2151	Ø 68 mm

S.ARAMITH	
Art. 2416	Ø 54 mm
Art. 300023	Ø 59 mm
Art. 2003	Ø 68 mm

S. ARAMITH	
Art. 2188	Ø 54 mm
Art. 2190	Ø 59 mm
Art. 2203	Ø 61,5 mm

ARAMITH	
Art. 216003	Ø 52,4 mm
Art. 217602	Ø 57,2 mm
Art. 2172	Ø 61,5 mm



VALUE PACK S.ARAMITH PRO
art. 2265 - Ø 57,2 mm



VALUE PACK / KIT SPECIALI

VALIGETTA ARAMITH

- nylon case
- available with Premium, Tournament, Super Aramith Pro and Pro-Tv set of balls
- microfibre Aramith cloth and Aramith polish ball included
- 17 spaces to insert each ball individually
- free space for a My Aramith personal cue ball or Jim Rempe training ball or Pro Cup ball
- Aramith logo on the case
- Sizes: 34 x 29 x 9 cm

- valigetta in nylon.
- disponibile con set di bilie Premium, Tournament, Super Aramith Pro e Pro-Tv.
- inclusi panno Aramith in microfibra e liquido puliscibilie Aramith
- 17 incavi per inserire all'interno ogni bilia singolarmente.
- uno spazio libero per la tua bilia personale My Aramith, o per la bilia da allenamento Jim Rempe o per una bilia Pro Cup.
- logo Aramith cucito sulla valigetta.
- misure: 34 x 29 x 9 cm

Balls/ bilie	Premium	S.Aramith Pro	S.Aramith Pro-Tv
Art.	2303	2304	2305

aramith® Tournament
Art. 2404



Patent pending
In attesa di brevetto

Aramith has created the new Tournament BLACK set to combine the very best of pool ball quality with an innovative, trendy and groundbreaking "black" design.

Anticipating the need to better discern the balls on TV but also on small screen devices, we have teamed up with Matchroom Multisport to develop new colours.

Aramith ha creato il nuovo set di bilie da pool Tournament BLACK accostando il meglio della qualità delle palline da biliardo ad un nuovo design "nero" inedito, di tendenza e innovativo (in attesa di brevetto).

Anticipando la necessità di discernere le palline in TV ma anche su dispositivi a piccolo schermo, Aramith ha collaborato con Matchroom Multisport per sviluppare nuovi colori e soddisfare al meglio le esigenze televisive.



The two half circle logo is a registered trademark of Saluc SA.

ARAMITH PRO CUP KIT / KIT ARAMITH PRO CUP

ART. 2378



Balls and related items

- * 1 Super Aramith® PRO-CUP pool set (including the famous 6 red dots cue ball)
- * 1 Jim Rempe learning cue ball + manual
- * 1 wooden ball triangle
- * 1 wooden 9-ball rack
- * 1 bottle of Aramith® Ball Cleaner
- * 1 Aramith® Micro Fiber Cleaning Cloth

Cues and related items

- * 4 top quality two-pieces pool cues
- * 1 two-pieces bridge stick
- * 1 brass bridge head
- * 1 wooden six-places cue rack
- * 1 Deluxe cue repair kit
- * 6 Aramith® chalks

Other Accessories

- * 1 10 1/2" horse hair table brush
- * 1 under rail brush
- * 1 leather tally shaker bottle
- * 1 set of wooden tally balls
- * 1 official rule book

Bilie e relativi prodotti

- * 1 Super Aramith Pro cup pool set (la famosa bilia con i 6 puntini rossi è inclusa)
- * 1 bilia allenamento + manuale
- * 1 triangolo in legno
- * 1 rombo 9 bilie in legno
- * 1 bottiglia di pulisci bilie Aramith
- * 1 panno micro fibra Aramith

Stecche e relativi prodotti

- * 4 stecche da pool 2 pz. di alta qualità
- * 1 stecca per bridge
- * 1 stella bridge
- * 1 porta stecche sei posti in legno
- * 1 kit ripara stecca Deluxe
- * 6 gessi Aramith

Altri accessori

- * 1 spazzola 10 1/2"
- * 1 spazzola sotto sponda
- * 1 fiaschetta per bazzica
- * 1 set di numeri in legno per bazzica
- * 1 libro con regole ufficiali

 aramith®

ARAMITH PREMIUM KIT / KIT ARAMITH PREMIUM

ART. 2379



Balls and related items

- * 1 Aramith® Premium pool set
- * 1 bottle of Aramith® Ball Cleaner
- * 1 Aramith® Micro Fiber Cleaning Cloth
- * 1 wooden triangle ball
- * 1 wooden 9-ball rack

Cues and related items

- * 4 two-piece pool cues
- * 1 two-piece bridge stick
- * 1 brass bridge head
- * 1 wooden six-places cue rack
- * 1 cue repair kit
- * 6 Aramith® chalks

Other Accessories

- * 1 10 1/2" table brush
- * 1 under rail brush
- * 1 leather tally shaker bottle
- * 1 set of wooden tally balls
- * 1 official rule book

Bilie e relativi prodotti

- * 1 Aramith® Premium pool set
- * 1 bottiglia di pulisci bilie Aramith
- * 1 panno micro fibra Aramith
- * 1 triangolo in legno
- * 1 rombo 9 bilie in legno

Stecche e relativi prodotti

- * 4 stecche da pool 2 pz.
- * 1 stecca per bridge
- * 1 stella bridge
- * 1 porta stecche sei posti in legno
- * 1 kit ripara stecca
- * 6 gessi Aramith®

Altri accessori

- * 1 spazzola 10 1/2"
- * 1 spazzola sotto sponda
- * 1 fiaschetta per bazzica
- * 1 set di numeri in legno per bazzica
- * 1 official rule book

 aramith®

STANDARD KIT / KIT STANDARD

ART. 2377



Balls and related items

- * 1 Aramith® Crown Standard pool set
- * 1 bottle of Aramith® Ball Cleaner
- * 1 Aramith® Micro Fiber Cleaning Cloth
- * 1 wooden ball triangle

Bille e relativi prodotti

- * 1 Aramith Crown Standard pool set
- * 1 bottiglia di pulisci bilie Aramith
- * 1 panno micro fibra Aramith
- * 1 triangolo in legno

Cues and related items

- * 4 two-pieces pool cues
- * 1 two-pieces bridge stick
- * 1 brass bridge head
- * 1 wooden six-places cue rack
- * 1 cue repair kit
- * 4 Aramith® chalks

Stecche e relativi prodotti

- * 4 stecche da pool 2 pz.
- * 1 stecca per bridge
- * 1 stella bridge
- * 1 portastecche sei posti in legno
- * 1 kit ripara stecca
- * 4 gessi Aramith

Other Accessories

- * 1 10 1/2" table brush
- * 1 official rule book

Altri accessori

- * 1 spazzola 10 1/2"
- * 1 libro con regole ufficiali

 aramith®

BILLIARD CLOTHES / PANNI DA BILIARDO

The market offers an outstanding number of billiard fabrics. But not all are capable to satisfy the very demanding billiard player. Very often the striving for exaggerated savings on cloth, destroys all the fun which a good billiard game is able to offer.

We, as Norditalia Ricambi srl, are working since the beginnings just with worldwide leading billiard cloth manufacturers. Quality is a very important issue in our philosophy and we try to offer outstanding products for any requirements.

Il mercato offre un vasto numero di panni da biliardo. Non tutti però sono in grado di soddisfare le molteplici esigenze dei giocatori. Molte volte l'esagerato risparmio nell'acquisto del panno distrugge tutto il divertimento che una partita di biliardo è in grado di offrire.

Norditalia Ricambi srl lavora sin da sempre con panni "guida" di fama mondiale. La qualità secondo la nostra filosofia è molto importante e vogliamo offrire molti prodotti adatti ad ogni richiesta.

SINCE 1680

 SIMONIS CLOTH

European company, leader in the production of billiard cloth, boasts a secular history. The factory Simonis was established in Verviers-Belgium in 1769. Simonis product is considered on mondial level, the ideal standard for carom (300), pool (760 and 860) and russian pyramid (760 and 860). The quality control is assigned to high qualified staff and thanks to the unique quality, this cloth is official recognised from many mondial billiard federation.

Azienda europea, leader nella produzione di panno da biliardo, vanta una storia secolare. La tessitura Simonis è stata fondata a Verviers - Belgio nel lontano 1769. Il loro prodotto è considerato a livello mondiale lo standard ideale per carambola (300), pool (760 e 860) e piramide russa (760 e 860). Il controllo della qualità è affidato a personale altamente preparato. Grazie all'impareggiabile livello qualitativo del prodotto è riconosciuto come panno ufficiale dalla quasi totalità delle federazioni mondiali.

RENZLINE

The Renzline brand is the eldest in the history of Italian billiard cloth manufacturing. The cloth is designed by Longoni, a tradition started by Renzo Longoni and taken over by his son Pierluigi. The cloth is manufactured in Italy and offers a good value product in alternative to common billard fabrics. A sophisticated production process and the cooperation with professional billiard players guarantees a consistent product quality.

Top products are Techno cloth, especially designed for 5 skittles, Reflex as a special cushion cloth and Arizona, an excellent worsted pool cloth.

E' il marchio più famoso e longevo nella storia del panno da biliardo Italiano. Nato dall'esperienza ultradecennale di Renzo Longoni e perfezionato dal figlio Pierluigi, questo marchio vanta una gamma di prodotti molto vasta impareggiabile nel rapporto qualità/prezzo. Nella gamma Renzline troviamo il Techno per il gioco dei 5 birilli, il Reflex adatto per le sponde e l'Arizona: un must per il gioco del pool.

All these fabrics have one point in common: each fabric sets the standard in its niche, meets the highest requirements of quality and performance. In case you need any assistance in choosing the "right" cloth, do not hesitate to contact our special trained sales team. We are offering a cutting service on all our billiard fabrics. We cut cloth for playfield and cushions according to your request and pack the cloth. Your advantages: checked cloth, defects free goods; no leftovers; reduced stock (especially on colours); easy handling.

Tutte queste tipologie di panno hanno un punto in comune: ogni panno colloca lo standard nella sua nicchia, incontra le maggiori richieste di qualità e performance. Nel caso in cui servisse assistenza per scegliere il giusto panno, per favore contattare il nostro personale di vendita qualificato. Offriamo un servizio di taglio per ogni panno. Tagliamo il panno per il piano e per le sponde secondo la richiesta e lo inscatoliamo. I vantaggi sono: panno controllato, merce senza difetti, no scarti, stock ridotto, facile da maneggiare.

SIZES FOR CUT CLOTH / MISURE PER TAGLI

Updated/Aggiornata al 29/08/14

STANDARD POOL TABLES					
SIZE / MISURE	pool 6'	pool 7'	pool 7' 1/2	pool 8'	pool 9'
playfield / campo gioco	180 x 90	200 x 100	210 x 105	224 x 112	254 x 127
slate / ardesia	191 x 99	222 x 120	228 x 123	241 x 130	272 x 145
CLOTH / PANNINO					
150 cm width / larg.	2,30 mt	2,90 mt	2,95 mt	3,10 mt	3,70 mt
165 cm width / larg.	2,00 mt	2,60 mt	2,65 mt	2,80 mt	3,40 mt
195 cm width / larg.	N.C.	N.C.	N.C.	2,50 mt	2,80 mt

CAROM / CARAMBOLA - 5 QUILLES / 5 BIRILLI TABLES				
SIZE / MISURE	K180,190	K 210	K230	K284 / 5 BIRILLI
playfield / campo gioco	190 x 95	210 x 105	230 x 115	284 x 142
slate / ardesia	210 x 109	232 x 125	252 x 135	302 x 160
CLOTH / PANNINO				
150 cm width / larg.	2,50 mt	3,10 mt	N.P.	N.P.
165 cm width / larg.	2,20 mt	2,70 mt	3,20 mt	3,05 mt (Playfield only / solo campogioco)
195 cm width / larg.	N.C.	2,40 mt	2,70 mt	3,40 mt

PYRAMID / PIRAMIDE RUSSA - SNOOKER TABLES		
SIZE / MISURE	10'	12'
playfield / campo gioco	294 x 147	356 x 178
slate / ardesia	305 x 157	366 x 187
CLOTH / PANNINO		
150 cm width / larg.	N.P.	N.P.
165 cm width / larg.	N.P.	N.P.
195 cm width / larg.	3,45 mt	4 mt (playfield/campogioco) + 1 mt (rails / sponde)

ITALIANA TABLES*		
SIZE / MISURE		
playfield / campo gioco	270 x 135	280 x 140
slate / ardesia	280 x 145	290 x 155
CLOTH / PANNINO		
150 cm width / larg.	N.P.	N.P.
165 cm width / larg.	2,90 mt (Playfield only / solo campogioco)	3 mt (Playfield only / solo campogioco)
195 cm width / larg.	3,35 mt	3,50 mt

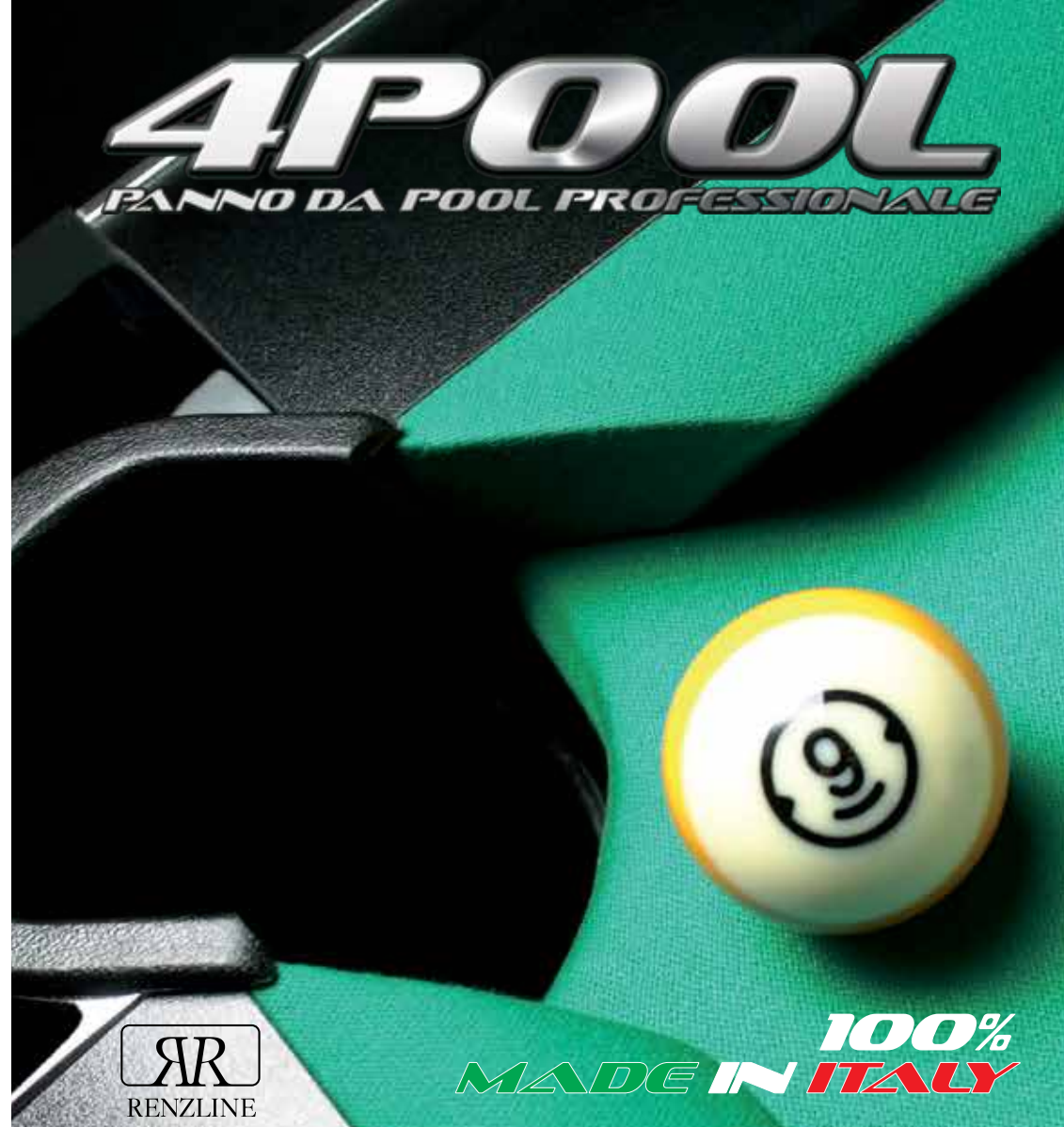

* Misure adatte anche per i biliardi De Agostini.

N.C. = not worth
no convenienza
N.P. = not possible
non possibile



Professional quality cloth, thick, suitable for pool game. Same quality as the approved clothes but very competitive in price. High percentage of selected wool.

Pannino di qualità professionale, spesso, adatto al gioco del pool. Qualità analoga a prodotti omologati ma molto competitivo nel prezzo. Alta percentuale di lana scelta.

	yellow green verde giallo	blue blu	
			70% wool / 30% polyester ; ± 430 g/m ² Width: 160 cm
h. 160 cm	14250	14704	70% lana / 30% poliestere ; ± 430 g/m ² Altezza: 160 cm

RENZLINE CLOTHES / PANNI RENZLINE



CALIFORNIA

POOL CLOTH / PANNO PER POOL

100% synthetic cloth but produced with quality materials. Very smooth and hardly tendency towards speckling

Panno totalmente sintetico ma realizzato con materiali di qualità. Molto scorrevole e con ridotta tendenza alle bollinature.

BEST PRICE

	yellow green verde giallo	blue blu
h. 165 cm	14694	14696

67% polyester / 33% viscose; ± 290 g/m²
Width: 160 cm and 167 cm

67% poliester / 33% viscosa; ± 290 g/m²
Altezza: 160 cm e 167 cm

BASIC

POOL CLOTH / PANNO PER POOL

100% synthetic cloth but produced with quality materials. Very smooth and hardly tendency towards speckling

Panno totalmente sintetico ma realizzato con materiali di qualità. Molto scorrevole e con ridotta tendenza alle bollinature..

	green verde
h. 165 cm	14698

65% polyester / 35% viscose; ± 185 g/m²
Width: 165 cm

65% poliester / 35% viscosa; ± 185 g/m²
Altezza: 165 cm

ARIZONA

POOL CLOTH / PANNO PER POOL

Arizona is an intermediate category cloth suitable for different purposes, particularly recommended for those looking for a fast cloth for pool and home carom tables.

Arizona è un panno di fascia intermedia adatto a molteplici scopi, specialmente a chi cerca un panno scorrevole per pool e tavoli da carambola per casa.

	blue blu	green verde	red rosso
h. 160 cm	14433	14422	14427

55% wool / 45% polyester;
± 300 g/m²
Width: 160 cm

55% lana / 45% poliester;
± 300 g/m²
Altezza: 160 cm



"760 / 860"
POOL CLOTH
PANNO PER POOL



	yellow green verde giallo	blue green verde blu	apple green verde mela	English green verde inglese	olive green verde oliva	dark green verde scuro
760/195	14069	14380	14425	14347	14564	13057
860/195	14127	14244	14520	14519	14566	14575
860/195 HR	14804	14805	-	-	-	-
	spruce verde abete	petrol blue blu petrolio	royal blue blue royal	marine blue blue marine	electric blue blu elettrico	tournament blue blu tournament
760/195	13080	14522	14313	13048	14312	14801
860/195	14577	14435	14381	14524	14395	14485
860/195 HR	-	-	14806	-	14809	14807
	powder blue blu polvere	fuksia fucsia	purple viola	red rosso	burgundy bordeaux	wine vino
760/195	14521	-	14138	14310	14593	14545
860/195	14436	14525	14597	14430	14595	14591
860/195 HR	14808	-	-	-	-	-
	camel cammello	gold oro	grey grigio	black nero	orange arancione	chocolate cioccolato
760/195	14584	14315	14314	14533	14803	14988
860/195	14588	14476	14526	14527	14624	14625

	slate grey grigio ardesia	blu royal fluo blue royal fluo
760/195	14706	14432
860/195	14682	-

"760 HIGH EFFICIENCY"
70% wool / 30% nylon ; ± 355 g/m²
Width: 195 cm

Excellent tournament pool cloth used all over the world since decades. Especially recommended for high traffic. This reference cloth is legend! It is also the best and most appropriate cloth for Russian Pyramid.

"760 ALTA EFFICIENZA"
70% lana / 30% nylon ; ± 355 g/m²
Altezza: 195 cm

Panno da pool veramente esclusivo usato in tutto il mondo da decenni. Altamente raccomandato per un gioco "intenso". E' un panno leggendario! E' anche il più appropriato per il gioco della Piramide Russa.

"860 PROFESSIONAL"

90% wool / 10% nylon ; ± 410 g/m²

Width: 195 cm

The exclusive tournament pool cloth chosen for all major pool tournaments and championships worldwide.

The greatest!

"860 PROFESSIONALE"

90% lana / 10% nylon ; ± 410 g/m²

Altezza: 195 cm

L'esclusivo panno da pool scelto per tutti i tornei e campionati del mondo. Il migliore!

"860 HR"

70% wool / 30% nylon ; ± 410 g/m²

Width: 195 cm

GAME: Professional cloth recommended for pool

A true hybrid (Worsted) Simonis 860HR® (High Resistance). It's the most durable commercial-grade billiard cloth made. It has the same weight as 860 cloth but the composition of the 760. It offers therefore the best compromise between ball control and game speed.

"860 HR"

70% lana / 30% nylon ; ± 410 g/m²

Altezza: 195 cm

DISCIPLINA: Panno professionale usato per il gioco del pool.

Panno "ibrido" che contiene parte delle caratteristiche del panno 860 e parte del 760. Ha infatti lo stesso peso del panno 860 ma la composizione del 760. Offre quindi il miglior compromesso tra controllo della bilia e velocità di gioco.

SINCE 1680



"920"

**SUITABLE FOR POOL/PYRAMID/ITALIANA
ADATTO A POOL/PIRAMIDE RUSSA/ITALIANA**

yellow green blue green English green empire green royal blue electric blue
verde giallo verde blu verde inglese verde impero blu royal blu elettrico



920/160	14679	-	-	14721	14680	14672
920/195	14350	14661	14662	-	14424	14660

powder blue purple red burgundy taupe chocolate
blu polvere viola rosso bordeaux taupe cioccolato



920/195	14667	14668	14434	14664	14626	14678
----------------	-------	-------	-------	-------	-------	-------

85% wool / 15% nylon ; ± 325 g/m²

Width: 195 cm

Perfect polyvalent cloth as well for home table (pool and carom) as for billiard rooms and for Russian Pyramid tables.

85% lana / 15% nylon ; ± 325 g/m²

Altezza: 195 cm

Panno dall'utilizzo polivalente, perfetto per tavoli da abitazione (pool e carambola) così come per sale e tavoli da piramide russa.

TECHNO

Super Pro Edition

**Il panno veloce, preciso, made in Italy.
La scelta dei campioni del mondo.**



RENZLINE

yellow green green blue sugar blue
verde giallo verde blu sugar blue

TECHNO SUPER PRO ED. h.160 cm	14677	14471VB	14677SB
REFLEX SUPER PRO 2.0 roll/rotolo	14654	-	-
REFLEX cushion set/set sponda	300560	-	-

INNOVATIVE SOLUTIONS FOR A PROFESSIONAL "5 SKITTLES" TABLE
SOLUZIONI PER UN TAVOLO PROFESSIONALE DA "5 BIRILLI"



TECHNO
Super Pro Edition

85% wool / 15% polyamide ± 350 g/m²
Width: 160 cm

Techno is a professional cloth for the 5 skittles game. The R&D process took years, searching for the right yarns and a state to the art finishing process. In cooperation with the three times world champion Gustavo Torregiani we were able to develop a billiard cloth which allows true rolling balls, excellent ball control and offers extraordinary speed. Numerous field tests have tested its durability and high performance over a long period of time, guaranteeing your investment as well.

Il panno professionale frutto di lunghe e approfondite ricerche su filati e finissaggi speciali. Sviluppato in collaborazione con giocatori del calibro di Gustavo Torregiani, tre volte campione del mondo, questo panno garantisce un'elevata velocità ed uno straordinario controllo sulla bilia. Numerose prove sono state fatte per migliorare la traiettoria soprattutto in quei tiri dove la velocità è ridotta e quando la bilia tende maggiormente a sbandare. La notevole durata garantisce numerose ore di gioco ad alto livello dando sicurezza al vostro investimento.



Art. 7272

Blu is the special rubber cushion especially for 5 skittles game, developed by Longoni and **ARTEMIS**®. The challenge was to create a cushion rubber that ensures consistent angles for a more accurate game. Because billiard is accuracy. For compatibility reasons BLU has the same K-79 profile as the traditional Artemis product.

Blu è la gomma speciale per il gioco dei 5 birilli studiata dal team Longoni in collaborazione con la tedesca ARTEMIS®.

La caratteristica principale di questa miscela, dall'inconfondibile color blu chiaro, è quella di garantire coerenza tra angolo incidente ed angolo uscente della bilia. Questo è il segreto principale di una buona gomma e questo è quello che abbiamo fatto. Blu ha un profilo uguale all'Artemis classica per garantire totale compatibilità nelle sostituzioni.

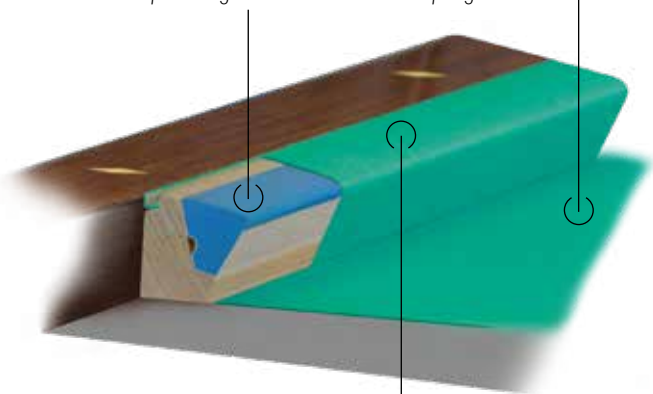

80% wool / 20% polyamide; ± 370 g/m²
Width: 160 cm

"Reflex" is a special designed woolen style rail cloth. The chosen pattern and yarn favour ball control, improving the affect of spin of the cueball. This cloth completes the package for a perfect playing billiard table, a package consisting in a balance between cloth, cushion rubber and rail cloth.

"Reflex" è il complemento naturale del panno Techno. Essendo un tessuto cardato, a differenza del Techno che è un pettinato, si presta ad essere un prodotto duraturo nel tempo. Grazie alla particolare tessitura e al titolo del filo, questo panno riesce a migliorare il controllo sugli effetti garantendo, quindi, un rientro della bilia corretto. La sua compattezza lo rende gradevole sia al tatto che esteticamente.

LASER 3.0

UN PANNO PERFETTO, ADESSO ANCORA PIU' VELOCE E RESISTENTE ALL'UMIDITA'.
IWAN SIMONIS - DAL 1680
PANNI DA BILIARDO CON MASSIME PRESTAZIONI

SINCE 1680



SIMONIS CLOTH



OMOLOGATO FIBIS

APPROVATO DALLA CEB
PER I TORNEI A SQUADRA
EUROPEI

yellow green
verde giallo

LASER/170	14998
-----------	-------

90% wool / 10% nylon ±510 g/ml
90% lana / 10% nylon ±510 g/ml

- FINO AL 20% PIU' DURATURO RISPETTO AGLI ALTRI MARCHI.
- VELOCE COME NON MAI.
- SCORRIMENTO DELLE BILIE PIU' PRECISO E FLUIDO.



"300 RAPIDO" playfield cloth / panno per piano

5-SKITTLES CLOTH / CAROM CLOTH
PANNO PER 5 BIRILLI / PANNO PER CARAMBOLA

yellow green verde giallo blue green verde blu empire green verde impero olive green verde oliva delsa blue blu delsa electric blue blu elettrico



300/170	14018	-	-	-	-	-
----------------	-------	---	---	---	---	---

300/195	14300	14016	14716	14715	14308	14382
----------------	-------	-------	-------	-------	-------	-------

prestige blue blu prestige red rosso burgundy bordeaux black nero



300/195	14714	14717	14718	14719
----------------	-------	-------	-------	-------



90% wool / 10% nylon ; ± 300 g/m²
Width: 170 and 195 cm

The cloth of the most important carom 3-cushions and artistic championships worldwide (B.W.A., C.E.B., Asian Games, U.M.B.). The best answer to all kind of games requiring high speed and precision. Really the cloth of champions!

90% lana / 10% nylon ; ± 300 g/m²
Altezza: 170 e 195 cm

Il panno dei più importanti campionati di carambola 3 sponde e carambola artistica (B.W.A., C.E.B., Asian Games, U.M.B.). La miglior risposta per ogni tipo di gioco che richiede velocità e precisione. E' veramente il panno dei campioni!

Strachan Cloth SINCE 1680 Iwan Simonis SIMONIS CLOTH

THE SNOOKER CLOTH
IL PANNO PER SNOOKER

olive green verde oliva



6811/193	25000
-----------------	-------

STRACHAN 6811 TOURNAMENT
100% wool; ± 931 g/m (30 oz/yd)
Width: 193

The professional most popular snooker cloth used at the IBSF World Championships.

100% lana; ± 931 g/m (30 oz/yd)
Altezza: 193 Panno professionale usato nei tornei e campionati mondiali IBSF per il gioco dello snooker.

olive green verde oliva

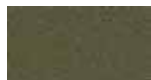

6811/196	25001
-----------------	-------

STRACHAN 6811 NEW CLUB
100% wool; ± 868 g/m (28 oz/yd)
Width: 196

Quality snooker cloth, suitable for all snooker tables.

100% lana; ± 868 g/m (28 oz/yd)
Altezza: 196
Panno di qualità usato per il gioco dello snooker. Adatto per tutti i tavoli da snooker.



Iwan Simonis is the undisputed world leader in the development of billiard cloth for all disciplines and we constantly improve our products to meet and exceed the expectations of amateur and professional players alike.

— **Simonis PRECISHOT®** cushion cloth

- Constant rebound
- Persistent spin retention

yellow green verde giallo blue green verde blu delsa blue blu delsa prestige blue blu prestige



3,05 mt - 45 cm h.	14989	14990	14991	14720
---------------------------	-------	-------	-------	-------

Simonis 300 RAPIDE bed cloth —

- Accurate
- Fast
- Burn mark resistant
- Silent

Our skilled engineers have worked closely with **the world's top players** to create a cushion cloth to be used with the Simonis 300 Rapide.



The Simonis PRECISHOT® cushion cloth breaks new ground for carom and offers improved and unequalled performance.

PRECISHOT® and 300 RAPIDE
by Iwan Simonis,
the winning combination.



MERCURY
Ultra Teflon

POOL CLOTH
PANNO PER POOL



yellow green
verde giallo



4045/165	13102
----------	-------

75% wool / 25% nylon
± 325 g/m²; Width: 165 cm

75% lana / 25% nylon
± 325 g/m²; Altezza: 165 cm

Mercury Ultra Teflon is the same unique fabric as Mercury Ultra but bathed in Dupont™ Teflon™ before weaving. This process creates the only true liquid resistant fabric.

Il panno Mercury Ultra Teflon ha le stesse caratteristiche del Mercury Ultra ma è bagnato nel Dupont Teflon prima della tessitura. Questo processo crea l'unico vero tessuto resistente ai liquidi.



art. 3040
Caliper, 36 cm (big)
Compasso, 36 cm (grande)



art. 3041
Caliper, 12 cm (small)
Compasso, 12 cm (piccolo)



art. 15914
Outline for the cushion control set 3 balls 63,2 mm
Sagome controlla sponda set 3 bilie 63,2 mm



Art. 15216
Ball position holder pool Ø 57,2 mm, plexiglass
Basetta segnaposto bilie pool Ø 57,2 mm in plexiglass



art. 18267
Ball position holder by Longoni (balls Ø 61,5 mm)
Basetta segnaposto Longoni (bilie Ø 61,5 mm)



art. 1095 - unit
Cloth marker
Pastello dermatografico



art. 14676
Ball positioner Ø 63,3 mm
Posizionatore bilie Ø 63,2 mm



art. 14149
Ball positioner Ø 61,5 mm
Posizionatore bilie Ø 61,5 mm



art. 17016
Distance meter, Bocchetta game
Squadretta per bocchette



art. 17015
Spot marker (balls Ø 61,5 mm)
Segnacastello (bilie Ø 61,5 mm)



art. 17970
Spot marker (balls Ø 63.2 mm)
Segnacastello (bilie Ø 63.2 mm)

**STICKY
ADESIVO**



Art. 3510
Invisible Rack Sheet 8-9-10 ball (set of 2 pcs)
Invisible Rack Sheet 8-9-10 bilie (set di 2 pz)



It allows you to place the balls in the right position on the playfield.

Thin laminated plastic card triangle.

It doesn't interfere during the game.

Posiziona le bilie perfettamente sul piano di gioco.

Triangolo di sottile carta plastificata.

Non interferisce durante il gioco.

**NON-STICKY
NON ADESIVO**



Art. 3479
Magic Ball Rack 9-10 ball (set of 6 pcs)
Magic Ball Rack 9-10 bilie (set di 6 pz)



art. 18029
Triangle "professional" Ø 57,2 mm
Triangolo "professionale" Ø 57,2 mm



Wooden triangle
Triangolo in legno

art.	discipline	Ø ball
18040	snooker	52,4 mm
18042	pool	57,2 mm
18067	pyramid	68 mm



Plastic triangle
Triangolo in plastica

art.	discipline	Ø ball
18035	pool	38 mm
18030	snooker	54 mm
6243	pool	50,8 mm
18031	pool	57,2 mm



art. 18173
Triangle for balls plexiglass
Ø 57,2 mm
Triangolo per bilie plexiglass
Ø 57,2 mm



art. 3044
Plastic rhomb for 9 ball
Rombo in plastica per 9 bilie



art. 3047
Wooden rhomb for 9 balls Ø 57,2 mm
Rombo in legno per 9 balls Ø 57,2 mm



art. 20006
Balls case, carom, Ø 61,5 mm
Portabilie carambola Ø 61,5 mm



art. 20009
Balls case, Pool, Ø 57,2 mm
Valigetta portabilie pool Ø 57,2 mm



Balls tray / Vassoio portabilie

art.	discipline	balls' n.	Ø
20019	italiana	3	68
20018	boccette	9	61,5
20016	snooker	22	52,4
20090	pool	16	57,2
20091	pyramid	16	68
20127	internazionale	3	61,5 63,2

ball cleaner

Art. 6171
BALLS POLISH MACHINE
220 V CE APPROVED

Art. 6171
LAVA BILIE
220W OMOLOGATA CE



art. 6260*
Spareparts ball polishing machine (art.6171) *colours can change without any previous notice
Panni ricambio per lavabilie (art.6171) *variazioni di colori possibili

A powerful polishing machine for billiard balls which removes traces of chalk and dirt. Best results when used together with Aramith's ball polish.

Ball polishing is really easy:

1. put some polish on the rotating surface
2. put balls into their place
3. switch the machine on

After about 3 minutes, balls are clean and shiny. To obtain an even better result use Norditalia's "Anti static" spray. Apply a small portion on a towel and wipe the balls. It removes residuals of the ball polish and reduces the electrostatic charges of the balls.

Una potente macchina per lucidare le bilie da biliardo che rimuove tutte le tracce di gesso ed impurità. Da utilizzare insieme al ball polish Aramith garantisce lunga durata alle bilie ed un gioco sempre preciso.

Il funzionamento è semplice:

dopo aver messo del polish sul piano rotante e aver posto le bilie nella sede, avviare la macchina. Dopo 3 minuti circa le bilie sono pronte per essere sgrassate con il liquido "anti-static" by Norditalia. Questo liquido rimuove oltre ai residui di polish, le cariche elettrostatiche che allontanano le bilie durante il gioco.



art. 17582
Antistatic protection for billard balls
Spray antistatico per bilie

art. 17582-12
Antistatic protection for billard balls. Box 12 pcs
Spray antistatico per bilie. Box 12 pz



art. 10223
Aramith ball polish
Liquido puliscibilie Aramith



art. 2272
Aramith ball restorer
Restorer bilie Aramith



art. 6242
Aramith micro fiber cloth
Panno Aramith in fibra



art. 17022
"New Mexico" brush
Spazzola "New Mexico"

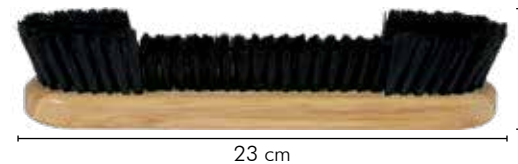

art. 17020
"Illinois" brush
Spazzola "Illinois"



art. 17023
"Michigan" brush
Spazzola "Michigan"

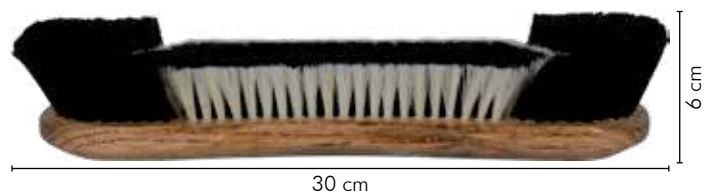

art. 17027
"Florida" Brush
Spazzola "Florida"



art. 17026
"Vermont" Brush
Spazzola "Vermont"



art. 26017
"Texas" Brush
Spazzola "Texas"



THE "BRUSH" REVOLUTIONIZING THE BILLIARD CLEANING
LA "SPAZZOLA" CHE RIVOLUZIONA LA PULIZIA DEL BILIARDO

Art.18184



Thanks to the "Simonis X-1 brush", forget the traditional bristles brush that doesn't make the chalk powder move from one point to the other.
The "Simonis X-1 brush" thanks to its technological pattern, takes the chalk powder out deep in the cloth wool and keep it inside its revolutionary structure. Working based on static electricity effects and capillarity.

Grazie alla "spazzola Simonis X-1" non avrete più bisogno di una spazzola tradizionale con setole che non fa che spostare la polvere di gesso da un punto all'altro.
La "Simonis X-1", grazie al suo tessuto tecnologico, estrae la polvere di gesso in profondità nella trama del panno e la trattiene all'interno della propria struttura rivoluzionaria. Il suo funzionamento è basato su effetti di elettricità statica e capillarità.

TABLE COVER / COPERTA PER BILIARDO

Cotton table cover
Coperta per biliardo in cotone



Plastic table cover
Coperta per biliardo in plastica



Vinyl table cover
Coperta per biliardo in vinile



	Pool 9' 300 x 200 cm	Carom 10' 380 x 240 cm	Snooker 12' 430 x 280 cm
cotton/cotone	3061	3060	-
Cotton with personalized logo Cotone con logo personalizzato	-	3069	-
plastic/plastica	3066	3064	3056
vinyl/vinile	-	3339	-

THERMIC SHIELD



THERMIC SHIELD, THE COVER FOR HEATED TABLES
LA COPERTA PER BILIARDI RISCALDATI



ART. 3561



SUPPLIED WITH A CONTAINING BAG

FORNITA CON PRATICA SACCA CONTENITORE

40%
ENERGY SAVING
DI RISPARMIO
ELETTRICO



SPECIAL COVER WITH THERMAL INSULATION WHICH GUARANTEES COST EFFICIENCY (40% ON THE BASIS OF OUR TESTS) KEEPING THE SLATE TEMPERATURE STEADY.

SUITABLE FOR HEATED BILLIARD TABLES WITH:
- EXTERNAL SIZES: 310/320 x 170/175 cm
- PLAYING FIELD: 284 x 142 cm
- WEIGHT: 3,4 kg

SPECIALE COPERTA CON ISOLAMENTO TERMICO CHE GARANTISCE UN FORTE RISPARMIO ENERGETICO (40% SECONDO TEST INTERNI) RENDENDO PIU' UNIFORME LA TEMPERATURA DELL'ARDESIA.

ADATTA A BILIARDI RISCALDATI CON:
- MISURA ESTERNA 310/320 x 170/175 cm
- CAMPO GIOCO 284 X 142 cm
- PESO: 3,4 kg



Turned skittles (not moulded), set
Birilli torniti, (non stampati), set

h	12 mm	15 mm	18 mm	25 mm
art.	2162	2089	2090	2291*
Ø	7.5	8	8	10

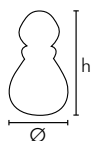

Plastic skittles (moulded), set 100 pcs
Birilli stampati in plastica, set 100 pz

h	18 mm	25 mm
art.	2093	2070
Ø	8	10

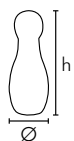

art. 2287*
Turned skittles (not moulded), 25 mm, set
Birilli torniti (non stampati), 25 mm, set

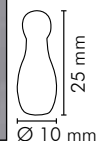

art. 2095
Skittles motherpearle, 18 mm, set
Birilli madreperla, 18 mm, set

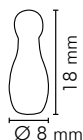

* according to FIBIS specifications
seguono specifiche FIBIS



art. 6010
Bottle for bazzica
Fiaschetta per bazzica

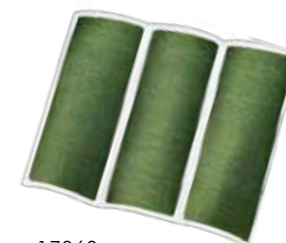

art. 17060
Cloth repair strip adhesive (green)
Striscetta verde autoadesiva (verde)



art. 12010
Bazzica plastic numbers, set
Numeri plastica per bazzica



art. 1001
Pool spots, 35 mm (12 pcs.)
Acchiti per pool 35 mm (12 pz.)

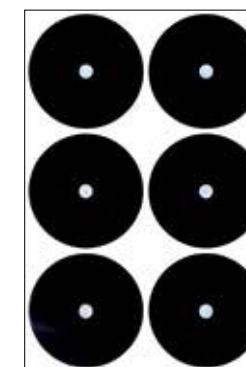

art. 1009
Pool spots, 58 mm (6 pcs.)
Acchiti per pool 58 mm (6 pz.)



art. 1022
Spots pour pool tefco (box 12 pcs)
Acchiti per pool tefco (box 12pz)

CUE RACKS / PORTASTECCHE



←
art. 17001
Cue rack for 6 cues
with ball rack
Portastecche 6 posti
con portabile



→
art. 17073
Cue rack 6 cues
mahogany with scorer
Portastecche 6 posti in
mogano con segnapunti



←
art. 17149
Cue rack for 6 cues
Portastecche 6 posti



→
art. 17140
28 x 28 x h.80 cm
Octagonal cue
stand for 8 cues
Portastecche
ottagonale 8 posti



→
Art. 18999
Cue rack mod. P40,
lacquered wood,
with drawer
Portastecche Mod. P40
legno laccato,
con cassetiera

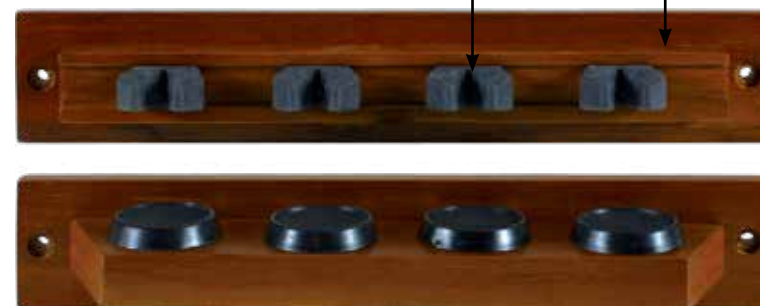

REAL RUBBER
VERA GOMMA
SOLIDWOOD
LEGNO MASSELLO

nr	4 cues	6 cues	8 cues	10 cues
Art.	17030	17031	17169	17032

Wall rack Z2
Portastecche Z2

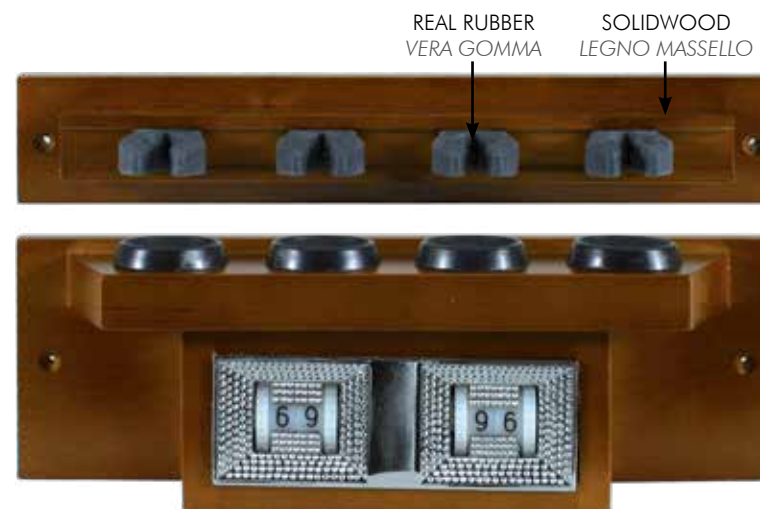

REAL RUBBER
VERA GOMMA
SOLIDWOOD
LEGNO MASSELLO

nr	4 cues
Art.	17134

Wall rack Z2 with scorer
Portastecche Z2 con segnapunti



art. 11040
Rubber cue clip
Molletta portastecca in gomma

art. 6040
Plastic cue rack support
Fondello portastecche in plastica

art. 1020
Plastic cue rack holder
Anello poggiatecche in plastica



MADE IN ITALY



MADE IN ITALY



Beta



Cue rack Beta

Portastecche Beta

nr	4 cues	6 cues
Art.	17603	17604



MADE IN ITALY

abs

Cue rack Abs
Portastecche Abs

nr	6 cues	12 cues
Art.	17167	17166



art. 17057
Key/lock for cue-locker
Chiave/serratura per chiusura singola



art. 17038
Ciphered key for cueslocker
Chiavi cifrate per armadietto



art. F604
Lock for cue locker art.17908
Serratura per armadietto art.17908



RENZLINE



art. 14800
Portable cuerack
Made of soft neoprene rubber, this product will provide the comfort of leaning your cue on each shelf or support without any risk. Weight: 500 gr

art. 14800
Portastecche da tavolo portatile
Stampato in morbido neoprene, questo prodotto vi darà la praticità di appoggiare senza rischi la vostra stecche ad ogni mensola o ripiano. Peso: 500 gr



art. 17908 - 106 x 107 x 28 cm
Cue locker, 4 doors, black
Armadietto portastecche 4 ante nero



art. 14810
Cuerack for table Predator
Portastecche da tavolo Predator





Art. 18249
Score marker "Ottocento" with abacus
Segnapunti "Ottocento" con pallottoliera



art. 18199 - 1000 x 46,5 cm
Scoremarker with ballsholder "Margherita"
Segnapunti "Margherita" per goriziana con portabile



art. 15196 - 38 x 30 cm
Scoremarker mahogany colour
Segnapunti colore mogano

art. 15195 - 38 x 30 cm
Scoremarker natural oak colour
Segnapunti color rovere



art. 12020
Numbers for scoremarker, set
Numeri per pallottoliera, set



art. 17011 - 25 x 35 x 6 cm
Scoreboard carom (small)
Segnapunti per carambola (piccolo)



art. 11010 - 63 x 7 x 2,5 cm
Scoremarker, max. 50 points
Marchiera a mano a 2 file italiana



art. 11014 - 63 x 7 x 2,5 cm
Scoremarker, max. 250 points
Marchiera a mano a 2 file goriziana



art. 11050 - 69 x 13 x 5 cm
Scoremarker frame, chromed brass
Struttura pallottoliera ottone cromato

ELECTRONIC SCOREMARKERS / SEGNAPUNTI ELETTRONICI



Art. 18108	without remote control senza telecomando
Art. 18134	with infrared remote control con telecomando a infrarossi

Scoremarker PLAY 6, black, for pool, snooker, quilles. Available with infrared or cable remote control (7mt cable). The device is protected against dust and smoke. Life span of buttons: aprox. 5 Mio. Touches. In case of power failure the count is saved in a memory and will not be lost. No batteries needed. Measures: 56 x 19,5 x 4 cm. Weight: 2,5kg. The led numbers are in red and green colour, 60mm high. Power consumption: max. 6VA 220V

Il segnapunti PLAY 6 (colore nero) è adatto per pool, snooker e 5 birilli. Disponibile con infrarossi o con cavo (7 mt.). Il sistema è protetto da polvere e fumo. Durata dei bottoni: 5 Mio touches approssimativamente. In caso di calo di corrente, il conto è salvato in una memoria e quindi non va perso. Non sono necessarie batterie. Misure: 56 x 19,5 x 4 cm. Peso: 2,5 kg. I led dei numeri sono di colore rosso e verde, altezza 60 mm. Consumo: massimo 6VA 220V.



Art. 18138	without remote control senza telecomando
Art. 18139	with infrared remote control con telecomando a infrarossi

Scoremarker PLAY 6T, black. Description as Art. 18108, but with additional count down clock on a 25mm high led display. Ideal for speed pool or other sports games with time limit. Available with an infrared remote control as well.

Il segnapunti PLAY 6T (nero) di cui vale la descrizione qui sopra, ha in aggiunta un orologio di count down con un display led centrale (25mm). Ideale per il pool veloce o giochi con tempo limite. Disponibile anche con telecomando a infrarossi.



Art. 18109	without remote control senza telecomando
Art. 18137	with infrared remote control con telecomando a infrarossi

Scoremarker PLAY 8, black. Description as Art. 18108, but with additional display of sets or frames on a 25mm high led display. Available with an infrared remote control as well.

Infrared remote control: range 15m. A new system allows the use of different remotes in the same place without configuration of different codes. Power supply: Alkali battery 9V for aprox. 140.000 commands. The remote control is made of aluminium, 14,5 x 5,5 x 2,2 cm (L,W,T) . Diaphragm keyboard prevents the electronics from dirt and liquids.

Il segnapunti PLAY 8, (nero) di cui vale la descrizione del Play 6, ha in aggiunta una serie di display led (25mm). Disponibile anche con telecomando a infrarossi.

Controllo con infrarossi : distanza 15 m. Un nuovo sistema permette di usare differenti remotes nello stesso posto senza configurazione di codici diversi. Alimentatore: batteria Alkali 9V per circa 140,000 comandi. Il controllo remoto è fatto di alluminio, 14,5x5,5x2,2 cm . Un diaframma permette di proteggere lo strumento da polvere e liquidi.



Art. 18119	cable remote control con telecomando a cavo
------------	------------------------------------------------

Scoremarker PLAY 8 black. Description as art. 18137, but with cable remote control (cable 7m).
Segnapunti PLAY 8 nero. Descrizione come per art. 18137 ma con telecomando a cavo (7mt).



Art. 18112	without remote control senza telecomando
Art. 18156	cable remote control con telecomando a cavo
Art. 18155	with infrared remote control con telecomando a infrarossi

Scoremarker GAME ON FOR DARTS, available with an infrared or a cable remote control as well (cable length 7m). Technical description and measures as Art. 18109 PLAY 8.

Il Segnapunti GAME ON PER DARDI è disponibile con infrarossi o telecomando a cavo. Descrizione e misure come per art. 18109 PLAY 8.



Art. 18063	electronic scoremarker Play 20 segnapunti elettronico Play 20
------------	------------------------------------------------------------------

Scoremarker PLAY 20 with cable remote control (cable 30m, extendable). Wall fixing. On request also available with double sided display (Art. PLAY 20d, sealing fixing) and/or infrared remote control. Display height 20cm, visibility 50 m. To command the scoreboard a second command keyboard can be linked to the board.

Range of the infrared remote control: PLAY 20: 25 - 35m; PLAY 20d: 15 - 25m
Measures: 85 x 38 x 11 cm; Weight: 9,5 kg; Keyboard: 15,5 x 9 x 1,5 cm

Il segnapunti PLAY 20 con telecomando a cavo (estendibile a 30 mt) è fissato al muro. Su richiesta è disponibile anche con un sistema di display doppio (Play20d) e/o con controllo a infrarossi. Altezza display 20 cm, visibilità 50 m. Per regolare il segnapunti può essere installata una tastiera. Distanza per infrarossi: Play 20: 25 -35 m. Play 20d: 15 - 25 m. Misure: 85 x 38 x 11 cm. Peso : kg, 9,5 kg. Tastiera: 15,5 x 9 x 1,5 cm.



Art. 18065	cable remote control con telecomando a cavo
Art. 18154	with infrared remote control con telecomando a infrarossi

Scoreboard PLAY 14 with cable or infrared remote control for Billiards, Snooker, Pool, Darts, etc. Especially designed for tournaments! Display height 11,5cm, visibility 30m. Three displays each player: two 3-digit displays and one 1-digit display. Indication of players turn. Remote control featuring diaphragm keyboard, length of cable 18m. Depending on the played game the board has different statistics like average score, high score, etc. Measures: 75 x 59 x10 cm. Weight: 11,6kg. Power supply: 40VA 220V

Il Segnapunti PLAY 14 con telecomando a cavo o a infrarossi è adatto per Snooker, Pool, Dardi etc. E' stato studiato appositamente per tornei. Altezza del display: 11,5 cm, visibilità 30 mt. Tre display per ogni giocatore con indicazione dei turni dei giocatori. Lunghezza del cavo 18 mt. Il segnapunti è in grado di visualizzare diverse statistiche a seconda del gioco. Misure: 75 x 59 x 10 cm. Peso: 11,6 kg. Potenza: 40VA 220V

HEATING SYSTEMS / SISTEMI DI RISCALDAMENTO

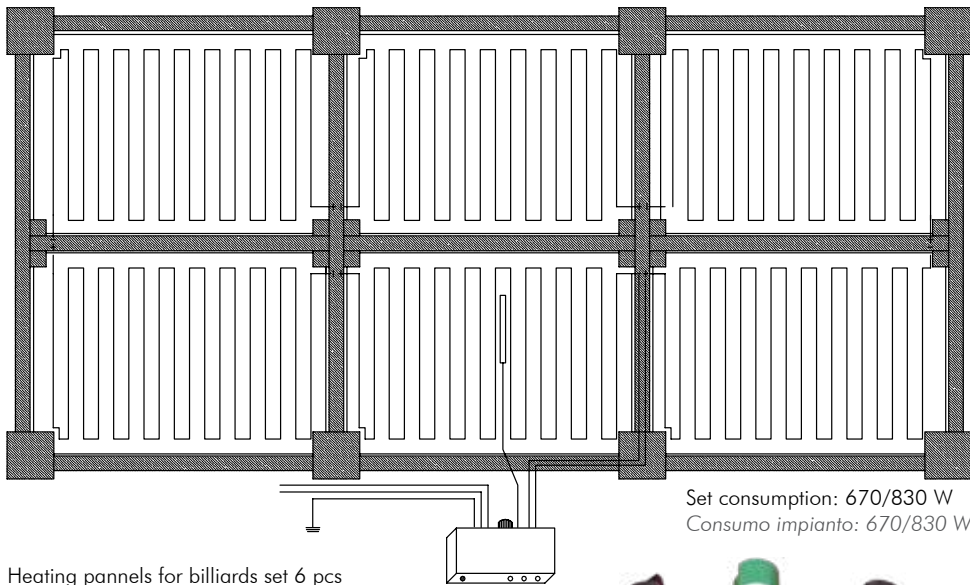

Set consumption: 670/830 W
Consumo impianto: 670/830 W

Heating pannels for billiards set 6 pcs
Pannelli per riscaldamento set 6 pz.

size misura	82 x 60 cm	84 x 62 cm	customized personalizzabile
art.	16021	16108	16121



Control lamp for heating system
Luce gemma per cassetta riscaldamento

	red rosso	green verde	orange arancione
art.	10453	10452	10454



art. 18020
Thermostat
Termostato



art. 300172
Wire for billiard heatings, 1Ω for 1m
Filo per pannelli riscaldamento, 1Ω x 1m

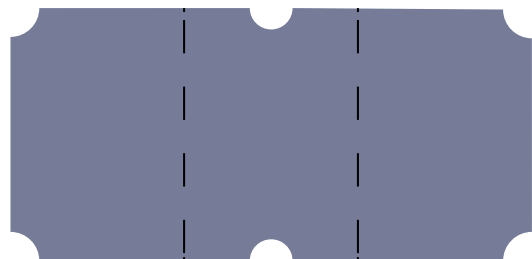

Slate pool with frame (without cloth)
Ardesia 3 pz. con telaio (senza panno)

art.	size misura	thickness spessore	weight peso
17873	8'	25 mm	215 kg
17863	9'	25 mm	275 kg



art. 18116 - 16 x 6 x 6,5 cm
Heating system control unit "thermodelta"
Termostato per riscaldamento biliardo "thermodelta"



art. 18201 - 16 x 6 x 6,5 cm (Brier / radica)
Heating system control unit "thermodelta"
Termostato per riscaldamento biliardo "thermodelta"



art. 16999 - unit
Score counter for rails,
bronze colour
Segnapunti per sponde,
color bronzo



art. 17003 - unit
Score counter for rails,
silver colour
Segnapunti per sponde,
color argento



art. 17000 - set (2)
Score counter for rails,
gold colour
Segnapunti per sponde,
color oro



art. 17007 - set (2)
Score counter medium
Segnapunti per sponde tipo medio



art. 17174 - unit
Chromed caps for Longoni coin-op
billiard rails
Tappo cromato per pool Longoni



art. 7101
Rubber ring for leg levellers
Ø 15 cm
Anello gomma per piedino
regolabile Ø 15 cm



art. 300160
Spare lock for pool
Serratura di ricambio per pool



art. 14166
Leg leveller standard metal, Ø 15 cm
Piedino regolabile in metallo, Ø 15 cm



art. 14054
Leg leveller, metal, Ø 15 cm
Piedino regolabile in metallo
Ø 15 cm



art. 7117
Leather pocket t x hole, set
Guarnizioni pelle per buche, set



art. F636 - set 6 pcs/pz.
Metal corners for pool Prostar Tour Edition
Angolari per pool Prostar Tour Edition



art. F19 - set 6 pcs/pz.
Metal corners for pool Las Vegas
Angolari per pool Las Vegas



art. 300179 - set 4 pcs/pz.
Corners varnished black for Longoni pool tables
Angolari verniciati per pool Longoni, neri



art. 300158 - set 4 pcs/pz.
Metal corners for pool tables
Angolari per pool in metallo



**BACK AGAIN
NUOVAMENTE DISPONIBILI**

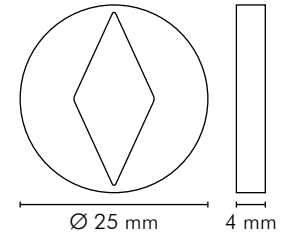

art. 1007
Black round sights with inlayed white rhomb Ø 25 x 4 mm
Losanghe nere con intarsio a rombo bianco Ø 25 x 4 mm

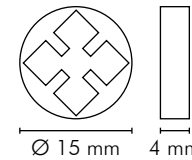

art. 10330
Black round sights with inlayed white cross
Losanghe nere, intarsio a croce bianco

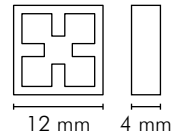
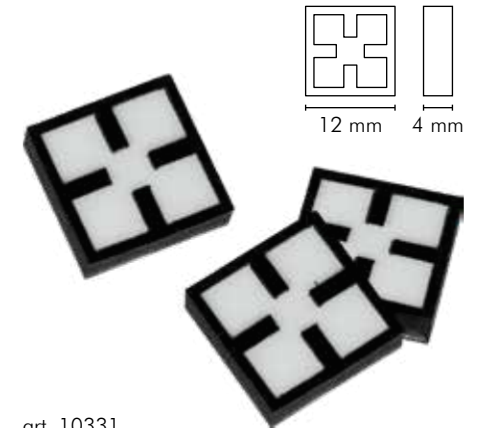

art. 10331
Black round sights with inlayed white cross
Losanghe nere, intarsio a croce bianco

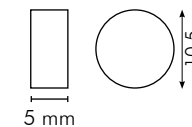
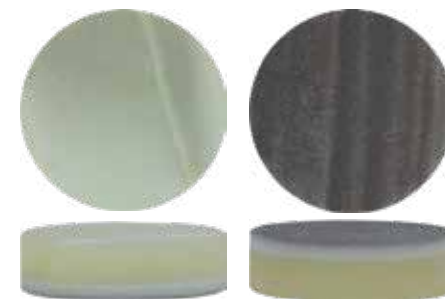

art. 1008
Round sights of mother of pearl
Acchiti madreperla

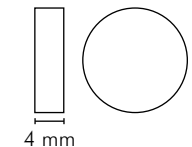

art. 10329
Round sights of mother of pearl
Acchiti madreperla

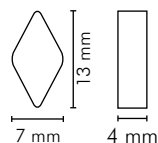

art. 10069
Plastic sights, rounded edges
Losanghe in plastica angoli arrotondati

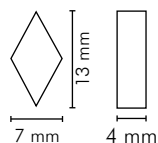

art. 10050
Plastic sights
Losanghe in plastica



art. 6020
Pocket lining set for Italian billiards
Gioco fodere buche



art. 12004
Profile brass, light or satin. h.50 mm.
Suitable for all billiards.
Nastro ottone, lucido o satinato. h.50 mm.
Adatto a tutti i tipi di biliardo.



Art. 14168 - set 6 pcs/pz
Web pocket, plastic
Pocket rete a cestello, plastica



art. 14344 - set 6 pcs/pz
Web pocket "Centurion", plastic
Pocket rete a cestello "Centurion", plastica



art. 14231 - set 6 pcs/pz
Pocket "Century", plastic
Pocket "Century", plastica



art. 14586 - set 6 pcs/pz
Pocket "Prostar Club" and "Las Vegas", rubber black.
Pocket "Prostar Club" e "Las Vegas", gomma nera.



art. 14708 - set 6 pcs/pz
Pocket "Prostar Club Tour Edition", rubber black.
Pocket "Prostar Club Tour Edition", gomma nera.



art. 7100 - set 6 pcs/pz
Gully boots, plastic
Gully boots, plastica



art. 14154 - set 6 pcs/pz
Pocket "West", leather
Pocket "West", pelle



art. F320 - set 6 pcs/pz
Pocket for russian pyramid
Pocket piramide russa



art. 14157 - set 6 pcs/pz
Web pocket "Atlantic", leather
Pocket a rete "Atlantic", pelle



art. 14128 - set 6 pcs/pz
Pocket liners, rubber 100 mm
Pocket liners, gomma 100 mm



art. 14060 - set 6 pcs/pz
Pocket liners, plastic 75 mm
Pocket liners, plastica 75 mm

art. 14061 - set 6 pcs/pz
Pocket liners, plastic 100 mm
Pocket liners, plastica 100 mm

DIAMOND SLICER

ART.9572

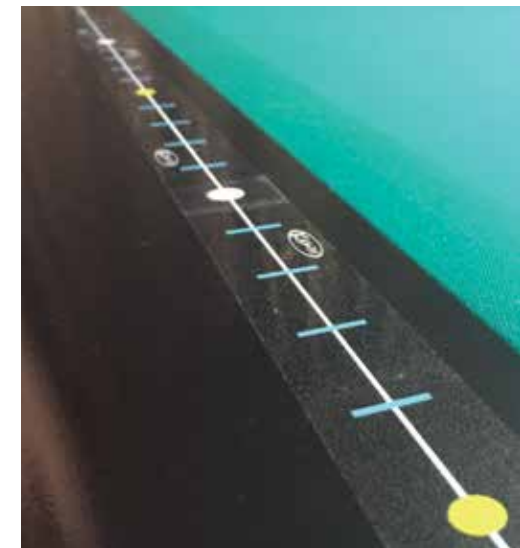
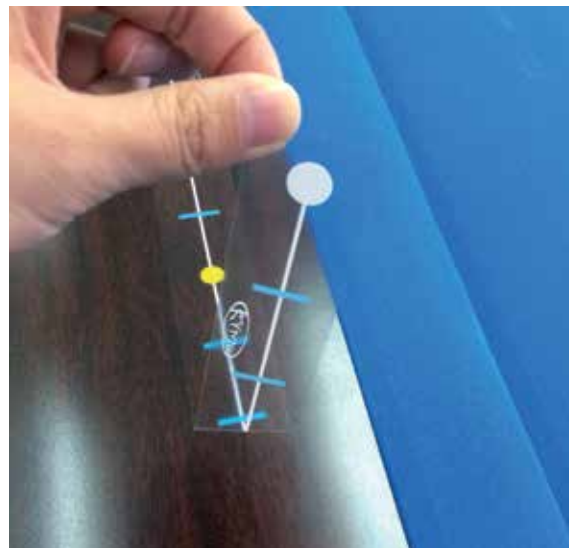

GIVE MORE ACCURACY TO YOUR SHOTS

- It divides the original 2 diamond points to 10 points.
- It is made of adhesive material that can be removed easily without leaving residue or marks on the rail.
 - Available for 9ft pool table.
 - A set is composed by 24 pcs.

DAI PIU' PRECISIONE AI TUOI TIRI

- Divide la distanza tra i due acchiti in dieci punti.
- Materiale adesivo facilmente rimovibile. Non lascia traccia.
- Disponibile per pool 9'.
- Set da 24 pz.

CUSHION RUBBERS* / GOMME* PER BILIARDO

5-SKITTLES K-79 / 5 BIRILLI K-79



Art. 7272

Rubber cushion "Blu" Longoni professional (Price by meter - std. length 3mt)

Gomma "Blu" Longoni professionale (Prezzo per metro - lunghezza std. 3mt)

*Please, test the rubbers and make to sure that they work correctly before mounting the cloth.

*Testare le gomme ed assicurarsi del corretto funzionamento prima del montaggio del panno.



ARTEMIS®

art. 7087

Rubber cushion Intercontinental Internazionale n°79 original (Price by meter - std. length 3mt)

Gomma intercontinentale per internazionale (Prezzo per metro - lunghezza std. 3mt)



LONGONI - SPECIAL FOR PYRAMID

LONGONI - SPECIALE PER PIRAMIDE RUSSA



art. 7262	art. 7364
1,55 mt	1,80 mt

Rubber cushion Blu Longoni professional (Price by meter)

Gomma Blu Longoni professionale (Prezzo per metro)

CAROM - FRENCH STANDARD

CARAMBOLA - STANDARD FRANCESE

ARTEMIS®



art. 7138

Rubber cushion Intercontinental n°37 original (Price by meter - std. length 3mt)

Gomma intercontinentale per internazionale (Prezzo per metro - lunghezza std. 3mt)

CAROM / 5-SKITTLES K-79 / PYRAMID

CARAMBOLA / 5 BIRILLI K-79 / PIRAMIDE RUSSA

SMERALDO



**COST EFFECTIVE!
ECONOMICA
DI CLASSE!**

Rubber cushion "Smeraldo" (Set price)
Gomma "Smeraldo" (Prezzo per set)

cm 145 x 6 pcs	cm 300 x 3 pcs
7244	7099

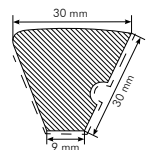

PROFESSIONAL POOL K-66
PROFESSIONALE PER POOL K-66
ARTEMIS®

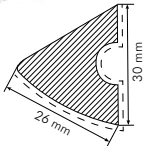

art. 7079
 Rubber cushion n°66 BIBA ROT 6 pcs set for 9' pool table (Set price)
 Gomma n°66 BIBA ROT set 6 pz. per pool 9' (Prezzo per set)



Rubber cushion B/G (Set price)
 Gomma B/G (Prezzo per set)

7"	8"	9"
cm 96 x 6 pcs	cm 109 x 6 pcs	cm 120 x 6 pcs
7204	7205	7206



Rubber cushion Championship Pro-Am (Set price)
 Gomma Championship Pro-Am (Prezzo per set)

7"	9"
cm 92 x 6 pcs	cm 120 x 6 pcs
7265	7256



SPECIAL / SPECIALI

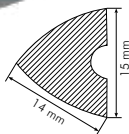

art. 7081
 Rubber cushion triangle black, 14 mm
 (Price by meter - std. length 1mt)
 Gomma triangolare nera, 14 mm
 (Prezzo per metro - lunghezza std. 1mt)

CAROM K-55/CARAMBOLA K-55

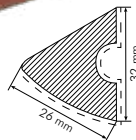
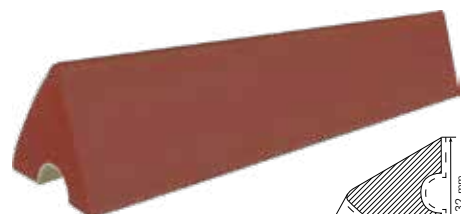

art. 7098 - set 3 pcs/pz.
 Rubber cushion "Royal", 290 cm (Set price)
 Gomma "Royal", 290 cm (Prezzo per set)

SNOOKER

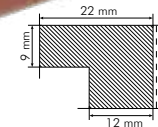
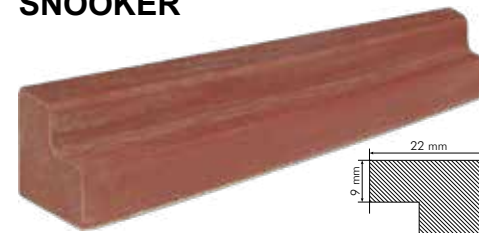

art. 7104 - set 6 pcs/pz.
 Rubber cushion for snooker, 183 cm 72" (Set price)
 Gomma per snooker, 183 cm 72" (Prezzo per set)

ITALIANA

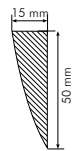

art. 7249
 Rubber cushion "Para bionda Nir", 130 cm
 (Unit price)
 Gomma "Para bionda Nir", 130 cm
 (Prezzo al pezzo)

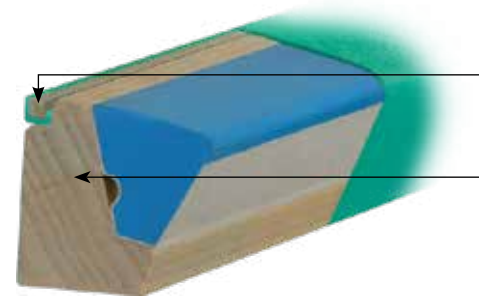

art. 16031 unit
 Wooden strip 164 cm to stop the cloth
 Striscette in legno da 164 cm per bloccare il panno

art. 18002 - set
 Beech rail liner "Internazionale" K-79 - 3 mt
 (rubber excluded)
 Tamburo in faggio per profilo K-79 - 3 mt
 (gomma esclusa)



art. 14030
 Parchement list for rails,
 128 cm
 Lista pergamena per tamburi,
 128 cm



art. 4000
 Wedges for billiard (bag of 50pcs)
 Cunei per biliardo 50 pz



art. 18001 - 11 x 6 x h. 3,5 cm
 Italian table wooden rail liner, 180 cm
 Tamburo per italiana, 180 cm



art. 17058 - set 12 pcs/pz.
 Cushion rubber facings
 Gomette per testate sponde



art. 14216 - set
Rail liner with cloth. For Longoni pool
Tamburo per pool con panno. Per pool Longoni



art. 14213 - set
Rail liner without cloth. For Longoni pool
Tamburo per pool senza panno. Per pool Longoni



art. 10305
Prismatic level 0,35x1000, length 30 cm
Livella prismatica 0,35x1000, lunghezza 30 cm



art. 11200
Cloth puller
Tendi-panno



Nails
Semenzine 1000 gr (vendute al kg)

3024	3026	3025
14 mm	16 mm	18 mm



Nails
Sellerine 2500 gr (vendute al kg)

3022	3020	3021	3023
8 mm	10 mm	12 mm	14 mm



art. 10107
Staples remover for cloth, mod. 313
Levagraffette per panno, mod. 313



art. 10108
Nails remover for cloth, mod. 310
Levachiodi per panno, mod. 310



art. 14029
Magnetic hammer for billiard
Martello calamitato per biliardo



art. 10109
Nails remover for cloth, mod. 307
Levasemenzine per panno, mod. 307



art. 3086
Cement "super" for cushions, 750 gr
Colla "super" per sponde, 750 gr



art. 3031
Cement "303", 900 gr
Colla universal "303", 900 gr



art. 4002
Diluent for glue "303", 800 ml
Diluyente per colla "303", 800 ml



art. 3039
Vinyl glue, 1000 gr
Colla vinilica, 1000 gr



art. 3032
Glue pvac for rails (5 skittles)
Colla pvac per sponde internazionale



art. 3486
Spray glue for cloth
Adesivo spray per panno



art. 17052
Filler for slate, 500 ml, included hardener
Stucco per ardesia, 500 ml, incluso induritore



art. 17053
Hardener for filler
Induritore per stucco



CLOTH art. 17049 CLEANER

Renew and clean your cloth!
It will appear as **NEW!**

Rinnova e pulisci il tuo panno.
Sembrerà **NUOVO!**

Before / Prima



After / Dopo



Suitable for 5 skittles, pool and carom billiard tables.
Turn off the billiard heating system at least one hour before the cleaning.

Adatto per biliardi da 5 birilli, pool e carambola.
Spegnere il riscaldamento del biliardo almeno un ora prima della pulizia.

Best result with the
CLASSIC TEXAS!

Massimo risultato con la
SPAZZOLA TEXAS!

art. 26017



AS SEEN ON



LONGONIGUES

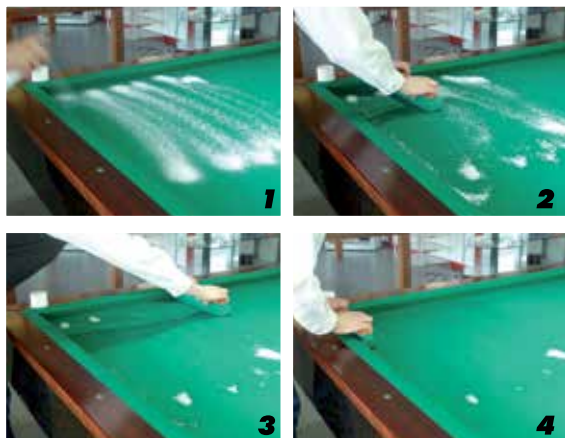

POSTERS



art. 15042
Poster 85x60 cm



art. 300213
Poster I win 61x76 cm



art. 300211
Poster Wanna play? 78x62 cm



art. 15014
Ancient coloured print 70x50 cm
Stampa antica colori 70x50 cm



art. 15204
Poster "Aramith 3D vintage"
48x67,5 cm



art. 15198
Poster "One too many?" 60x92 cm



art. 15049
Poster 87x61 cm



art. 15003 - Set (5)
Poster dogs 51x39 cm
Poster cani 51x39 cm



art. 15184
Poster Elisa Bridges 88x60 cm



art. 15005
Poster della Chiesa 61,5x87 cm

BALL KEY-RINGS / PORTACHIAVI A BILIA



art. 1408801-2-3-4-5-6-7-8-9-10-11-12-13-14-15
Ball key-ring Ø 25 mm
Bilia portachiaivi Ø 25 mm



art. 224800
Bilia portachiaivi eco. Set
Numbered key-ring eco. Set

BILLIARD CLOCKS / OROLOGI DA MURO Batteries not included / Pile non incluse



art. 13300 - Ø 29,5 mm
Wall clock n.8, black
Orologio da parete n.8, nero



art. 13301 - Ø 29,5 mm
Wall clock n.8, green
Orologio da parete n.8, verde



art. 13303 - Ø 20 mm
Wall clock, white
Orologio da parete, bianco

BOOKS & RULES / LIBRI & REGOLAMENTI



art. 18245
Rules Fibis for billiard - Italian only
Regolamento biliardo Fibis a calendario - Lingua Italiano



art. 10173
Book "Scuola di biliardo", Italian
Libro "Scuola di biliardo", italiano



MULTI TIMER SYSTEMS / TASSAMETRI EVOLUTI



art. 18210 Centralina MICRO 32 VERSIONE A
art. 18222 Centralina MICRO 32 VERSIONE B

Computerized timer system for use with up to 32 sport or game units like pool tables, ping-pong, Internet stations and many more. Equipped for all currencies. Wide possibilities of control functions and statistics. Individual adjustable time zones and Club tariffs. Connectors for printer, light control units and ball boxes.

Version A: Pecuniary input and statement of other costs like food and drinks.

Version B: as described before. Additional:

Memory for additional service descriptions (p.e. "Beer", "Sandwich", "Coke".) Player move in between two sport units. Power consumption: 7VA 220V. Measures: W: 37 cm , H: 11 cm , D: 16 cm Weight: 4,7 kg

Micro 32 è un computer appositamente studiato per la gestione fino a 32 tavoli da biliardo, ping pong, posizioni Internet e quant'altro. Programmabile per ogni tipo di moneta. Ampia possibilità di controllo delle funzioni e delle statistiche. Dispone di 3 tariffe orarie e 3 tariffe club programmabili individualmente. Connettori per la stampante, control-ball e control-lamp disponibili su richiesta.

Versione A: oltre alla gestione delle fasce orarie e delle tariffe club, è possibile programmare le consumazioni.

Versione B: in aggiunta alle funzione della versione A, possiede: 4a tariffa nelle fasce orarie, tasti speciali bar, accensione lampadari per pulizie, funzioni di stampa supplementari, scambio fra due tavoli.

Dati tecnici: alimentazione: 220/7VA; dimensioni: 37 x 11 x 16 cm; peso: 4,7 kg



art. 18218 Timer MICRO 8
art. 18218/P Timer MICRO 8-P
with printer port / con uscita stampante

MICRO 8, Description as Micro 32, but for use with up to 8 sport and game units. No input and statement of additional costs. With or without connector for a printer. Power consumption: 7VA 220V. Measures: W: 21,3 cm , H: 12,3 cm , D: 5,6 cm Weight: 0,75 kg

E' un computer appositamente studiato per la gestione fino a 8 biliardi con tariffa oraria, ma può essere utilizzato in tutti i casi nei quali serve addebitare il tempo. A differenza del Micro 32, non è possibile programmare consumazioni. Solo il Micro 8P ha la possibilità di collegamento della stampante. Dati tecnici: alimentazione: 220/7VA; dimensioni: 21,3 x 12,3 x 5,6 cm; peso: 0,75 kg



art. 18211 PRINTER for Micro 8-P and Micro 32
art. 18211 STAMPANTE per Micro 8P e Micro32

Robust typewriter ribbon colour printer for print out of statistics and statements. To use with MICRO 32 and MICRO 8-P only.

Stampa su 40 colonne. Utile per la stampa dello scontrino, dei totalizzatori e della programmazione. Utilizzabile sia per il computer Micro 8P che per il Micro 32.

Spare parts for printer / Parti di ricambio per la stampante

art. 18130	Colour strip for printer Citizen 562 Nastro per stampante Citizen 562
art. 18228	Colour strip for printer Citizen Model 460 Nastro per stampante Citizen 460



art. 18214	art. 18213	art. 18220
16 lamps	8 lamps	4 lamps

CONTROL LAMP UNIT

This device contains the electronics and relays to handle up to 16 billiard lamps or other power consumers, which are controlled through a MICRO 8 or MICRO 32 timer system. On each power out a consumer of max. 5A and 250V can be connected. Power supply 220V. Available in three sizes for 4, 8 and 16 billiard lamps or power consumers.

CONTROLLO LAMPADARI

Serve per comandare l'accensione di lampadari (fino a 16) o altri carichi elettrici. Per il funzionamento è da collegare al computer Micro 8 o Micro 32. Il carico elettrico massimo di connessione è 5A e 250V. Alimentazione 220V. Disponibile per la gestione di 4, 8 o 16 lampadari o carichi elettrici.



art. 18212	art. 18219	art. 18226
16 balls	8 balls	4 balls

CONTROL BALL UNIT

This device contains the electronics to handle up to 16 ball boxes for any billiard or pool game, which are controlled through a MICRO 8 or MICRO32 timer system. On each power out a consumer of max. 5A and 250V can be connected. Power supply 220V. Available in three sizes for 4, 8 and 16 billiard lamps or power consumers.

CONTROLLO BILIE

Serve per controllare i BOX (cassetti) contenenti le bilie. Per il funzionamento è da collegare al computer Micro 8 o Micro 32. Il carico elettrico massimo di connessione è 5A e 250V. Alimentazione 220V. Disponibile per la gestione di box da 4, 8 o 16 bilie.

WALL MOUNTED BOX / BOX DA MURO



art. 18206 - carom/internaz
BOX 3B Ø 61,5 mm / Ø 63,2 mm
21,5 x 22 x 11,2 + 7,8 cm - 4,35 kg



art. 18205 - bocchette
BOX 9B Ø 61,5 mm
21,5 x 22 x 11,2 + 7,8 cm - 4,35 kg



art. 18204 - pool
BOX 16B Ø 57,2 mm
26 x 26 x 11,2 + 7,8 cm - 6 kg

art. 18224 - pyramid
BOX 16B Ø 68 mm
32 x 32,5 x 11,8 + 7,8 cm - 8,4 kg





art. 18207 - snooker
BOX 22B Ø 52,4 mm
32 x 32,5 x 11,2 x 7,8 cm - 8.4 kg



art 18118
BOX PING PONG
26 x 26 x 11,2 + 7,8 cm - 5,9 kg

The ball boxes are attached through the Control Ball units to the timer system MICRO 8 or MICRO 32. Also available in a stack-up version.

Per il funzionamento dei box è necessaria una connessione ad un controll-ball o ad un computer Micro 8 o Micro 32. Disponibili anche nella versione per bilie impilabili

STACK-UP BALL BOXES / BOX IMPILABILI



art.	description/descrizione	measures/misure	weight peso
18206L	BOX 3B Ø 61,5 mm - carom/intern	21,5 x 22 x 11,2 cm	4,25 kg
18209L	BOX 4B Ø 61,5 mm - carom/intern	21,5 x 22 x 11,2 cm	4,25 kg
18205L	BOX 9B Ø 61,5 mm - bocchetta	21,5 x 22 x 11,2 cm	4,25 kg
18204L	BOX 16B Ø 57,2 mm - pool	26 x 26 x 11,2 cm	5,8 kg
18224L	BOX 16B Ø 68 mm - pyramid	32 x 32,5 x 11,8 cm	8,43 kg
18207L	BOX 22B Ø 52 mm - snooker	32 x 32,5 x 11,2 cm	7,9 kg
18118L	BOX PING PONG	26 x 26 x 11,2 cm	5,7 kg

Configuration for Multi-pool table System
Configurazione multipla per tavolo da biliardo



SPARE-PARTS FOR TIMER / PARTI DI RICAMBIO PER TIMER



Electronic card for TIMER 3-22B
Scheda elettronica per TIMER 3-22B
Art 18004 with time zones
con fascia oraria
Art 18006 without time zones
senza fascia oraria



art. 18005
Micro switch for lamp control for
TIMER 3-22B
Switch ricambio per lamp control
per TIMER 3-22B



art. 18008
+/- button for TIMER 3-22B
+/- bottone per TIMER 3-22B



art 18216
Lithium battery for TIMER 3-22B
Batteria al litio per TIMER 3-22B



art. 18013
Button for TIMER 3-22B
Bottone per TIMER 3-22B



art. 18215
Extension 15 m for MICRO 8/32
Prolunga 15 m per MICRO 8/32

STAND ALONE TIMERS / TASSAMETRI SINGOLI

- Suitable for Pool, Billiards, Snooker, etc. . The solution for all billiard games charged at an hourly tariff.
- Battery-operated (Lithium battery, lifespan 8-12 years).
- For use in all countries (money value programmable).
- 100% control on balls.
- Two programmable tariffs, incorporated electronic book-keeping, separated controls for staff and operator, patented ball control mechanism.
- Optional:
 - LIGHT CONTROL SWITCH. At the start of count the lamp over your pool tables will be switched on
 - DIFFERENT TIME ZONES. Automatic change in between three different tariffs.
- Both options on request.

- Adatti per pool, snooker, carambola, piramide russa e altro. La soluzione per tutti i biliardi funzionanti a tariffa oraria. - Dotato di una batteria interna al litio mantiene l'apparecchiatura sempre accesa per un minimo di 8-12 anni (mediamente). Tale batteria è facilmente reperibile nei negozi di elettronica.
- Adatto a tutte le nazioni poichè si può programmare sia il simbolo monetario che il valore di ogni scatto (unità monetaria) che può essere: 0,05 - 0,10 - 0,20 - 0,50 - 1 - 2.
- Si possono programmare due tariffe, è dotato di un sistema di archivio interno, totalizzatori separati per lo staff e per gli operatori. Sistema di chiusura con controllo presenza bilie (brevettato).
Materiale opzionale su richiesta:
- COMANDO LAMPADARIO. Offre la comodità dell'accensione automatica del lampadario quando l'orologio è in conteggio si aumenta la sicurezza contro eventuali frodi.
- FASCE ORARIE. È utile per sfruttare le ore di punta, sia giornaliere che settimanali. Si possono predisporre 3 tariffe orarie che si alterneranno automaticamente su delle fasce orarie programmabili.



art. 18100 - carom/internaz
TIMER 3B Ø 61,5 mm
21,5 x 22 x 19 cm - 5,1 kg



art. 18131 - carom/internaz
TIMER 4B Ø 61,5 mm
21,5 x 22 x 19 cm - 5,1 kg



art. 18101 - bocchette
TIMER 9B Ø 61,5 mm
21,5 x 22 x 19 cm - 5,1 kg



art. 18102 - pool
TIMER 16B Ø 57,2 mm
26 x 26 x 19 cm - 6,5 kg



art. 18176 - pool
TIMER 16B Ø 52 mm
26 x 26 x 19 cm - 6,5 kg



art. 18105 - pyramid
TIMER 16B Ø 68 mm
32 x 32,5 x 19,5 cm - 9 kg

art 18104
with time zones/con fasce orarie



art. 18103 - snooker
TIMER 22B Ø 52,4 mm
32 x 32,5 x 19 cm - 9 kg



art 18117
TIMER PING PONG
26 x 26 x 19 cm - 6,5 kg



Art. 18009 TIMER LCD 20
TIMER LCD 20, the easiest and less expensive way to operate your pool or billiard table, airhockey, solarium, card tables, tennis courts...etc. on an hourly tariff.
- Battery operated (lithium battery, lifespan 8- 12 years)
- For all countries (money value programmable)
State of the art electronic solutions, no need of a external power supply and low consumption guarantee high reliability and function.
Robust metal casting. Measures: 18,6 x 10,6 x 7,2 cm - Weight: 1,07 kg.

La soluzione più semplice ed economica per addebitare il tempo. Adatto per biliardi, air hockey, solarium, tavoli da gioco, tennis e altro.
- dotato di una batteria interna al litio mantiene l'apparecchiatura sempre accesa per un minimo di 8-12 anni (mediamente). Tale batteria è facilmente reperibile nei negozi di elettronica.
- adatto a tutte le nazioni poichè si può programmare sia il simbolo monetario che il valore di ogni scatto (unità monetaria)
Non necessita di alimentazione di rete, eliminando così problemi dovuti a sovra-tensioni di linea o interruzioni di energia elettrica. Risulta perciò pratico da posizionare in qualsiasi luogo. Supporto robusto di metallo.
Misure: 18,6 x 10,6 x 7,2 cm - Peso: 1,07 kg.



Art. 18007 TIMER LCD 20/S
TIMER LCD 20/S, description as art. 18009, LCD 20, but including the follo-wing extras:
1) Power socket. To the power socket, to see on the right in the picture, an external device can be connected (p.e. dartgame) which is operated at 220 Vac or 110Vac at the moment the START button is activated.
2) Service key for a second bookkeeping, showing the statistics of the current shift.

Oltre ad avere tutte le caratteristiche del modello LCD 20, ha 2 ulteriori funzioni:
1) PRESA di alimentazione per un carico elettrico.
2) CHIAVE SERVICE (utile per il personale dipendente).



Art. 18018 TIMER LCD 20/B
TIMER LCD 20/B, description as art. 18009, LCD 20, but with ball rack for Ping Pong balls or similar (ball Ø 35-40 mm).
The moment the ball is taken out of the rack the timer starts to count. By putting back the ball to the rack the timer stops counting and shows the due amount.
Measures: 23,3 x 10,6 x 7,2 cm - Weight: 1,27 kg.

Stessa descrizione dell' art. 18009 ma con sede per pallina da ping pong o similare (Ø 35-40 mm). Nel momento in cui la pallina viene estratta il timer inizia a calcolare l'importo. Si ferma nel momento in cui viene riposta.
Misure: 23,3 x 10,6 x 7,2 cm - Peso: 1,27 kg



Art 18225
INTERNETACCESSPC, an electronic modul which operates in cooperation with a MICRO 8 or MICRO 32 Timer system PC in an Internet Cafè. It is inserted in between the PC and the mouse or keyboard. (PS - 2)
INTERNET ACCESS PC, un modulo elettronico che opera in collaborazione di un Micro 8 o Micro 32 in un Internet Caffè. E' inserito tra il Pc e il mouse o la tastiera. (PS - 2)



Art 18177 32 port
Art 18178 64 port
Art 18179 96 port

PC INTERFACE 32 TO 96. This system allows to operate your pool- and billiard room through your own PC, but using the ball and light control units of the MICRO 8 and MICRO 32 Timer systems.

Connection through a RS232 interface. The necessary software with the OCX- components and the communication protocol is included on a CD and has to be integrated in the used account program. Available in three versions for operation of 32, 64 or 96 pool-and billiard tables. Measures: 16 x 12 x 7,7 cm - Weight: 0,6 kg

PC INTERFACE 32 FINO 96. Il sistema permette di operare dal tuo PC monitorando la tua sala da biliardo, con il sistema di controllo bilie o lampadari Micro 8 o Micro 32. La connessione è tramite un'interfaccia RS232. Il software necessario con componenti OCX e la comunicazione di protocollo è inclusa in un CD e deve essere integrata nel programma account usato. Disponibile in 3 versioni per operazioni di 32, 64, 96 tavoli da biliardo. Misure: 16 x 12 x 7,7 cm - Peso: 0,6 kg

COIN-TIMER

The cointimer is a multi-use single timer device, available with a coinshute and bill acceptor (optional). It can be used for all appliances in which an hourly tariff is charged on a electric powered game or other device (like videogames, illumination of tennis courts, internet terminals, electronic darts, solariums). In conjunction with ball boxes the Cointimer is also available for pool and billiard tables.

Il cointimer è un dispositivo multi uso, disponibile con gettoniera e accettori di mo-neta (optional). Può essere usato in tutte le applicazioni nelle quali venga caricata una tariffa oraria su un dispositivo elettronico o altro sistema (come videogiochi, illuminazione di campi da tennis, internet, dardi elettronici e solarium). Oltre che per cassetine bilie, il Cointimer è disponibile anche per tavoli da biliardo.



COIN-TIMER available models/modelli disponibili			measures/misura	weight peso
18123	BASIC	without ballbox/senza cassetto per bilie	21,5 x 35,5 x 21,5 cm	6 kg
18141	COIN TIMER PING-PONG	controls 2 rackets and one ball gestione di 2 racchette ed 1 pallina	216 x 47 x 26 cm	11,4 kg
18125	COIN TIMER 9B	Bocchette - 9 balls Ø 61,5 mm	21,5 x 47 x 22 cm	10 kg
18126	COIN TIMER 16B	Pool - 16 balls Ø 57 mm	26 x 47 x 126 cm	11,4 kg
18140	COIN TIMER 16B/68	Russian Pyramid - 16 balls Ø 68 mm	32,5 x 47,5 x 32,2 cm	13,6 kg
18127	COIN TIMER 22B	Snooker - 22 balls Ø 52,4 mm	32,5 x 47 x 35,5 cm	13,6 kg
<p>Above mentioned item numbers refer to versions with mechanic coinshutes for single coins. (0.50 - 1.00 - 2.00) Mechanic coinshute for tokens or electronic coinshute for coins on request. I codici sopra citati si riferiscono a versioni con gettoniera meccanica per singole monete (0.50 - 1.00 - 2.00) A richiesta: gettoniera meccanica per gettone o gettoniera elettronica per monete (0.05 - 0.10 - 0.20 - 0.50 - 1.00 - 2.00)</p>				

LONGGOMI
Carom cues
Stecche carambola

Longoni carom pros

Marco Zanetti



Eddy Merckx



Frédéric Caudron



Dick Jaspers



JP De Bruijn



Martin Horn



Jean Reverchon



Therese Klompenhouwer



Hyung Bum Hwang



Pierre Soumagne



Eddy Leppens



Birol Uymax



Alexander Salazar



Henry Diaz



Carlos Campino



Gilsen Degener



Tommy Carlsen





COLLECTION LUX XX

ART. 24147 with n.2 S2 WJ
ART. 24632 with n.2 S20 WJ

COLLECTION XX

ART. 24052 with n.2 S2 WJ
ART. 24700 with n.2 VP2



AMALIA

by FRÉDÉRIC CAUDRON

ART. 24525 with n.2 S30 WJ
ART. 24526 with n.2 S20 WJ
ART. 24535 with n.2 S20 VP2
ART. 24536 with n.2 S30 VP2
ART. 24574 with n.2 PRO4 VP2

ARMONIA

by FRÉDÉRIC CAUDRON

ART. 27783 with n.2 S2 WJ
ART. 27784 with n.2 S20 WJ
ART. 24417 with n.2 S2 VP2
ART. 24418 with n.2 S20 VP2
ART. 26253 with n.2 S30 VP2

ARMONIA LIGHT

by FRÉDÉRIC CAUDRON

ART. 24599 with n.2 S20 WJ
ART. 24600 with n.2 S30 WJ
ART. 24597 with n.2 S20 VP2
ART. 24598 with n.2 S30 VP2

EMMES

by EDDY MERCKX

ART. 24540 with n.2 S20 WJ
ART. 24541 with n.2 S30 WJ
ART. 24538 with n.2 S20 VP2
ART. 24539 with n.2 S30 VP2
ART. 24576 with n.2 PRO4 VP2

OLANDA

30th ANNIVERSARY

by DICK JASPERS

NEW MODEL COMING SOON

The wide range of Longoni products is constantly evolving. Please, get in touch with the website LONGONICUES.COM to be always updated. Details and models can be changed without any previous notice.

La gamma Longoni è in costante evoluzione. Visitare il sito LONGONICUES.COM per una visione aggiornata. Dettagli e modelli possono variare senza obbligo di avviso preventivo.

LONGONI
Made in Italy Since 1945

EVOLUZIONE

by MARCO ZANETTI

ART. 24454 with n.2 S2 WJ
ART. 24455 with n.2 S20 WJ
ART. 24448 with n.2 S2 VP2
ART. 24447 with n.2 S20 VP2
ART. 26255 with n.2 S30 VP2

INNOVATION MH

by MARTIN HORN

ART. 24623 with n.2 S20 VP2
ART. 24624 with n.2 S30 VP2

PARIS SEOUL

by PIERRE SOUMAGNE

ART. 24685 with n.2 Pro VP2
ART. 24686 with n.2 S2 VP2
ART. 24687 with n.2 S20 VP2
ART. 24688 with n.2 S30 VP2

ISTANBUL

by GULSEN DEGENER

NEW MODEL COMING SOON
ART. 24715 with n.2 S2 VP2
ART. 24714 with n.2 S20 VP2



LONGONI
Made in Italy Since 1945

SENSAZIONE

by THERESE

KLOMPENHOUWER

ART. 24513 with n.2 S2 VP2
ART. 24514 with n.2 S20 VP2
ART. 24515 with n.2 S30 VP2

THE KING

by JP DE BRUIJN

ART. 26825 with n.2 S2 VP2
ART. 26824 with n.2 S20 VP2
ART. 26256 with n.2 S30 VP2

LEPPENS

by EDDY LEPPENS

ART. 26820 with n.2 S2 VP2
ART. 26819 with n.2 S20 VP2
ART. 26254 with n.2 S30 VP2

ELDORADO

by ALEXANDER SALAZAR

CARLOS CAMPIÑOHENRY DIAZ

ART. 24398 with n.2 S2 VP2
ART. 24399 with n.2 S20 VP2
ART. 26245 with n.2 S30 VP2
ART. 24606 with n.2 S2 WJ
ART. 24607 with n.2 S20 WJ
ART. 24608 with n.2 S30 WJ

The wide range of Longoni products
is constantly evolving.
Please, get in touch with the
website LONGONICUES.COM to be
always updated.
Details and models can be changed
without any previous notice.

La gamma Longoni è in costante
evoluzione.
Visitare il sito LONGONICUES.COM
per una visione aggiornata.
Dettagli e modelli possono variare
senza obbligo di avviso preventivo.



SCANDINAVIA

by **TONNY CARLSEN**

- ART. 26842 with n.2 PRO WJ
- ART. 26843 with n.2 S2 VP2
- ART. 26243 with n.2 S30 VP2
- ART. 22893 with n.2 PRO VP2

BLACK PEARL 2

by **JEAN REVERCHON**

- ART. 24689 with n.2 PRO VP2
- ART. 24690 with n.2 S2 VP2
- ART. 24691 with n.2 S20 VP2
- ART. 24692 with n.2 S30 VP2

GALAXY EBONY

- ART. 27780 with n.2 S20 VP2
- ART. 26259 with n.2 S30 VP2

GALAXY MAPLE

- ART. 27778 with n.2 S20 VP2
- ART. 26258 with n.2 S30 VP2

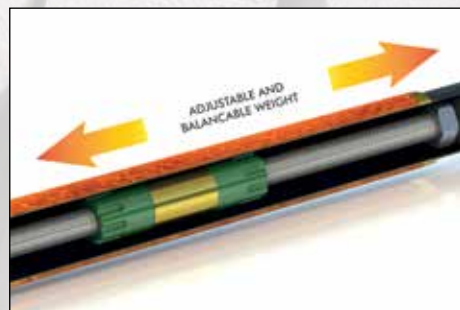

COMPOSITA

ART. 24583 with n.1 GRAPHITE VP2

The wide range of Longoni products is constantly evolving. Please, get in touch with the website LONGONICUES.COM to be always updated. Details and models can be changed without any previous notice.

La gamma Longoni è in costante evoluzione. Visitare il sito LONGONICUES.COM per una visione aggiornata. Dettagli e modelli possono variare senza obbligo di avviso preventivo.



CREMONA CARRIBEAN

ART. 26845 with n.1 S2 VP2

INSPIRATION

by MARTIN HORN

ART. 26060 with n.2 MAPLE E69

ART. 26061 with n.2 MAPLE E71

ART. 26059 with n.2 MAPLE C67



MADEIRA KOTIBÈ

ART. 24459 with n.1 S2 VP2

ART. 24460 with n.1 S20 VP2

PANAREA

ART. 25951 with n.1 MAPLE E71

ART. 25952 with n.1 MAPLE C67

PROCIDA

ART. 25953 with n.1 MAPLE E71

ART. 25954 with n.1 MAPLE C67

CRYSTAL FOX LEATHER

ART.24273 with n.1 MAPLE E71

ART. 24274 with n.1 MAPLE C67

CRYSTAL FOX

ART.24275 with n.1 MAPLE E71

ART. 24276 with n.1 MAPLE C67

The wide range of Longoni products is constantly evolving. Please, get in touch with the website LONGONICUES.COM to be always updated. Details and models can be changed without any previous notice.

La gamma Longoni è in costante evoluzione. Visitare il sito LONGONICUES.COM per una visione aggiornata. Dettagli e modelli possono variare senza obbligo di avviso preventivo.



GINEVRA XY

ART. 26220 with n. 1 MAPLE C67

COPENHAGEN CS13 HPG

ART. 24393 with n. 1 MAPLE C67

BLACK FOX 2 WOOD

ART. 24456 with n. 1 MAPLE C67

BLACK FOX 2 ALCANTARA

ART. 24693 with n. 1 MAPLE C67

BLACK FOX 2 ALCANTARA

ART. 24458 with n. 1 MAPLE C67

BS19

ART. 24523 with n. 1 MAPLE C67

TWINS

ART. 24601 with n. 1 MAPLE C67

ART. 24602 with n. 1 MAPLE CE71



FERRARA N

ART. 24423 with n. 1 MAPLE C67

ART. 24426 with n. 1 MAPLE E71

FERRARA G

ART. 24424 with n. 1 MAPLE C67

ART. 24427 with n. 1 MAPLE E71

FERRARA M

ART. 24425 with n. 1 MAPLE C67

ART. 24428 with n. 1 MAPLE E71

RAVENNA N

ART. 24420 with n. 1 MAPLE C67

RAVENNA R

ART. 24421 with n. 1 MAPLE C67

RAVENNA B

ART. 24422 with n. 1 MAPLE C67

The wide range of Longoni products is constantly evolving. Please, get in touch with the website LONGONICUES.COM to be always updated. Details and models can be changed without any previous notice.

La gamma Longoni è in costante evoluzione. Visitare il sito LONGONICUES.COM per una visione aggiornata. Dettagli e modelli possono variare senza obbligo di avviso preventivo.

STRATOS® LAMINATED SHAFTS

S2



S2 HAS 10 HIGHLY SELECTED CANADIAN HARD ROCK MAPLE SLICES AN ELASTIC SHAFT WITH DETERMINATION. PERFECT FOR THE MOST EXTREME ENGLISH

NAME	S2 E71	S2 C71	S2 C67
DISCIPLINE	3Cushion	3Cushion	Libre
PROFILE	Eiffel 71	Conic 71	Conic 67
LENGHT	70,5 cm	70,5 cm	67 cm
DIAM AV.	11,8/12 mm	11,8/12 mm	11/11,5/12 mm
WEIGHT	120/130 gr	125/140 gr	120/130 gr
RING	No	No	No
TIP	Kamui Oem	Kamui Oem	Kamui Oem
WJ	25824	25962	25822
VP2	25998	25996	25995

S30



S30 IS THE FIRST SHAFT IN THE WORLD TO HAVE THE INNOVATIVE STRUCTURE OF 10 SLICES OF QUEBEC HARD ROCK MAPLE AND 10 SLICES EUROPEAN HORNBEAM .

COMPARED TO S20 HAS HIGHER DENSITY AND SOLIDITY: PRECISION AND DETERMINATION.

NAME	S30 E71	S30 E69
DISCIPLINE	3Cushion	3Cushion
PROFILE	Eiffel 71	Eiffel 69
LENGHT	70,5 cm	69 cm
DIAM AV.	11.8 mm	11.8 mm
WEIGHT	115/129 gr	115/125 gr
RING	IMAGO	IMAGO
TIP	Fuji Sultan M	Fuji Sultan M
WJ	26236	26237
VP2	26234	26235

S20

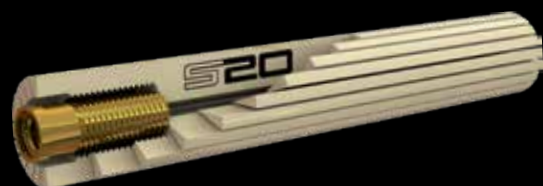

S20 IS THE FIRST SHAFT IN THE WORLD TO HAVE THE INNOVATIVE STRUCTURE OF 20 SLICES OF QUEBEC HARD ROCK MAPLE. THE GAME IS EASIEAR, NATURAL AND THE DEFLECTION IS HIGHLY COMPENSATED. THE INTERNAL STRUCTURE HAS BEEN DEVELOPED FOR AN OPTIMAL BALANCE.

NAME	S20 E71	S20 E69	S20 C71	S20 C69
DISCIPLINE	3Cushion	3Cushion	3Cushion	3Cushion
PROFILE	Eiffel 71	Eiffel 69	Conic 71	Conic 69
LENGHT	70,5 cm	69 cm	70,5 cm	69 cm
DIAM AV.	11.8 mm	11.8 mm	11.8 mm	11.8 mm
WEIGHT	115/129 gr	115/125 gr	125/129 gr	125/129 gr
RING	IMAGO	IMAGO	IMAGO	IMAGO
TIP	Fuji Camogli M	Fuji Camogli M	Fuji Camogli M	Fuji Camogli M
WJ	26192	26199	26193	26196
VP2	26194	26200	26195	26204

CLASSIC SOLID WOOD SHAFTS

PRO



REALIZED WITH THE BEST HARD ROCK CANADIAN MAPLE WOOD. SELECTED BY VEINING, WEIGHT AND COLOUR.

NAME	PRO 2+	PRO 4	PRO E69	PRO C67
DISCIPLINE	3Cushion	3Cushion	3Cushion	Libre
PROFILE	Eiffel 71	Conic 71	Eiffel 69	Conic 67
LENGHT	70,5 cm	70,5 cm	69 cm	67 cm
DIAM AV.	12 mm	12 mm	12 mm	10/10,5/11/11,5/12 mm
WEIGHT	115/130 gr*	132/138 gr*	110/120 gr*	110/130 gr*
RING	No	No	No	No
TIP	Da Vinci M	Da Vinci M	Da Vinci M	Da Vinci M
WJ	25637	25626	22272	24082
VP2	-	-	-	25988

*Add 5 more grams for vp2 joint



GOOD COMPROMISE BECAUSE THEY ARE PRODUCED WITH THE SAME MAPLE OF THE PRO SHAFT BUT LESS SELECTED: OPTIMAL PLAYABILITY WITH A MORE VINTAGE LOOK.

NAME	MAPLE E71	MAPLE E69	MAPLE C67	MASSE' C47
DISCIPLINE	3Cushion	3Cushion	Libre	Artistique
PROFILE	Eiffel 71	Eiffel 69	Conic 67	Conic 47
LENGHT	70,5 cm	69 cm	67 cm	47 cm
DIAM AV.	12 mm	12 mm	10/10.5/11/11.5/12	14.2 mm
WEIGHT	115/125 gr	110/125 gr	110/130 gr	90/110 gr
RING	No	No	No	No
TIP	Da Vinci M	Da Vinci M	Da Vinci M	Elk Master
WJ	25793	25958	24092	25695

COMPOSITE FIBER SHAFTS

PLAYING FIBRE TAKES YOUR GAME TO THE FUTURE. HIGHER REACTIVITY, UNDERFORMABLE AND LOW DEFLECTION ARE THE MAIN CHARACTERISTICS.

DIFFERENT NUMBER OF LAYERS AND MATERIALS MAKE THE FEELING DIFFERENT.

**LUNA
NERA**

PURE GRAPHITE SHAFT



NAME	LUNA NERA E71	LUNA NERA E69
DISCIPLINE	3Cushion	3Cushion
PROFILE	Eiffel 71	Eiffel 69
LENGHT	70,5 cm	69 cm
DIAM AV.	12 mm	12 mm
WEIGHT	115/130 gr	115/130 gr
RING	Psx black	Psx black
TIP	Kamui Oem SS	Kamui Oem SS
VP2	24591	24592

Hb



THE HB ONES ARE REALIZED IN EUROPEAN HORNBEAM WHICH IS SIMILAR TO HARD ROCK MAPLE BUT SLIGHTLY HARDER AND WITH A MORE GREY COLOUR.

NAME	HB C67
DISCIPLINE	Libre
PROFILE	Conic 67
LENGHT	67 cm
DIAM AV.	11/11.5/12 mm
WEIGHT	110/130gr*
RING	No
TIP	Da Vinci M
WJ	25636

*Add 5 more grams for vp2 joint

Woodcomp



NAME	WOODCOMP C69	WOODCOMP MASSE'	COMPOSITA D12	COMPOSITA D11
DISCIPLINE	3Cushion	Artistique	3Cushion	Libre
PROFILE	Conic 69	Conic 47	Conic 70	Conic 70
LENGHT	67 cm	47 cm	70 cm	70 cm
DIAM AV.	12 mm	14.2 mm	12 mm	11 mm
WEIGHT		150/170 gr		
RING		IMAGO	Psx black	Psx black
TIP	Kamui Oem SS	Elk Master	Modena	Modena
WJ	25185	25684		
VP2	24520	26203	24584	24585



Pool cues
Stecche da pool



Niels Feijen



FLAMES WOOD

by NIELS FEIJEN

- ART. 24565 with n.1 S2 VP2
- ART. 24569 with n.1 S20 VP2
- ART. 24573 with n.1 S30 VP2

FLAMES LEATHER

by NIELS FEIJEN

- ART. 24533 with n.1 S2 VP2
- ART. 24568 with n.1 S20 VP2
- ART. 24572 with n.1 S30 VP2

FLAMES LINEN

by NIELS FEIJEN

- ART. 24532 with n.1 S2 VP2
- ART. 24567 with n.1 S20 VP2
- ART. 24571 with n.1 S30 VP2

FLAMES LEATHER STRIPS

by NIELS FEIJEN

- ART. 24564 with n.1 S2 VP2
- ART. 24566 with n.1 S20 VP2
- ART. 24570 with n.1 S30 VP2



La gamma Longoni è in costante evoluzione.

Visitare il sito LONGONICUES.COM per una visione aggiornata.

Dettagli e modelli possono variare senza obbligo di avviso preventivo.



SPARKLE CURLY

by NIELS FEIJEN

ART. 24701 with n.1 S2 VP2
 ART. 24707 with n.1 S30 VP2
 ART. 24704 with n.1 LUNA
 NERA VP2

SPARKLE LINEN

by NIELS FEIJEN

ART. 24702 with n.1 S2 VP2
 ART. 24708 with n.1 S30 VP2
 ART. 24705 with n.1 LUNA
 NERA VP2

SPARKLE LEATHER

by NIELS FEIJEN

ART. 24703 with n.1 S2 VP2
 ART. 24709 with n.1 S30 VP2
 ART. 24706 with n.1 LUNA
 NERA VP2

TJB BREAK

by NIELS FEIJEN

ART. 26841 with n. 1 S2-BRK



COLLECTION LUX

ART. 22551 with n.2 S2 XP

DEDALO SILVER OCEAN

XVIII

ART. 24469 with n.1 PRO VP2

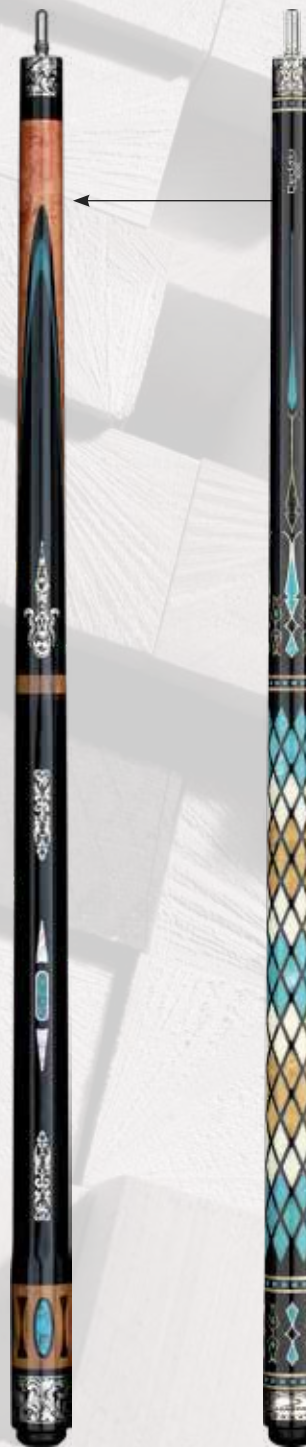

The wide range of Longoni products is constantly evolving. Please, get in touch with the website LONGONICUES.COM to be always updated. Details and models can be changed without any previous notice.

La gamma Longoni è in costante evoluzione. Visitare il sito LONGONICUES.COM per una visione aggiornata. Dettagli e modelli possono variare senza obbligo di avviso preventivo.



DEDALO OCEAN XVIII
ART. 24471 with n.2 PRO VP2

NIRVANA 2
ART. 24490 with n.2 S2 VP2

MAGNIFICA
ART. 24432 with n.1 S2 VP2

TOSCANA POOL
ART. 24391 with n.1 S2 VP2

MASAI
ART. 24338 with n.2 S2 VP2

MEDITERRANEO
ART. 24316 with n.1 S2 VP2

SIENA
ART. 24440 with n.1 PRO VP2



AOSTA
ART. 24442 with n.1 S2 VP2

MINERVA ROUND
ART. 24401 with n.1 S2 VP2

MINERVA OCTAGONAL
ART. 24400 with n.1 S2 VP2

MINERVA LINEN
ART. 24403 with n.1 S2 VP2

MINERVA LEATHER
ART. 24402 with n.1 S2 VP2



The wide range of Longoni products is constantly evolving. Please, get in touch with the website LONGONICUES.COM to be always updated. Details and models can be changed without any previous notice.

La gamma Longoni è in costante evoluzione. Visitare il sito LONGONICUES.COM per una visione aggiornata. Dettagli e modelli possono variare senza obbligo di avviso preventivo.



BLACK MAMBA SHINY STAR

ART. 24370 with n.1 S2 VP2

CREMONA CARRIBEAN

ART. 26849 with n.1 S2 VP2

MELODIA

ART. 24610 with n.1 S2 VP2

ART. 26826 with n.1 PRO VP2

T17 OCEAN

ART. 24610 with n.1 S2 VP2

ART. 26827 with n.1 PRO VP2



MALAGA STRIP

ART. 24531 with n.1 S2 VP2

LONGEVA

by WANG YE

ART. 24446 with n.1 S2 VP2

The wide range of Longoni products is constantly evolving. Please, get in touch with the website LONGONICUES.COM to be always updated. Details and models can be changed without any previous notice.

La gamma Longoni è in costante evoluzione. Visitare il sito LONGONICUES.COM per una visione aggiornata. Dettagli e modelli possono variare senza obbligo di avviso preventivo.

ENTRY LEVEL



HURRICANE 2 LINEN

ART. 24438 with n.1 MAPLE VP2

HURRICANE 2 WOOD

ART. 24437 with n.1 MAPLE VP2

HURRICANE 2 ORANGE

ART. 24492 with n.1 MAPLE VP2



The wide range of Longoni products is constantly evolving. Please, get in touch with the website LONGONICUES.COM to be always updated. Details and models can be changed without any previous notice.

STRATOS® LAMINATED SHAFTS SINCE 1965

S2



S2 HAS 10 HIGHLY SELECTED CANADIAN HARD ROCK MAPLE SLICES AN ELASTIC SHAFT WITH DETERMINATION. PERFECT FOR THE MOST EXTREME ENGLISH.

S2	AMERICAN D. 12,8 mm	SLIM D. 11,8 mm	BREAK D. 13 mm
RING	IMAGO	IMAGO	IMAGO
TIP	Kamui oem	Kamui oem	Kamui original H
VP2™ 29'	26162	26107	26135
VP2™ 30'	26163	-	-
5/16-18™ 29'	-	-	26141
UNI-LOC™ 29'	26164	26142	-

S20

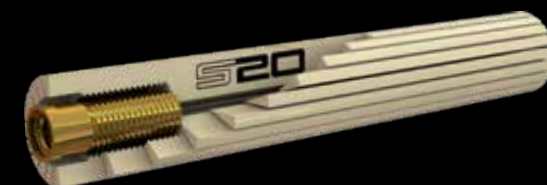

S20 IS THE FIRST SHAFT IN THE WORLD TO HAVE THE INNOVATIVE STRUCTURE OF 20 SLICES OF QUEBEC HARD ROCK MAPLE. THE GAME IS EASIEAR, NATURAL AND THE DEFLECTION IS HIGHLY COMPENSATED. THE INTERNAL STRUCTURE HAS BEEN DEVELOPED FOR AN OPTIMAL BALANCE.

S20	AMERICAN - D. 12,8 mm	WM - D. 12,4 mm
RING	IMAGO	IMAGO
TIP	Kamui oem	Kamui oem
VP2™ 29'	24527	24675

S30



S30 IS THE FIRST SHAFT IN THE WORLD TO HAVE THE INNOVATIVE STRUCTURE OF 10 SLICES OF QUEBEC HARD ROCK MAPLE AND 10 SLICES EUROPEAN HORNBEAM . COMPARED TO S20 HAS HIGHER DENSITY AND SOLIDITY: PRECISION AND DETERMINATION.

S30	AMERICAN - D. 12,8 mm	WM - D. 12,4 mm
RING	IMAGO	IMAGO
TIP	Kamui oem	Kamui oem
VP2™ 29'	24488	24524

CLASSIC WOODEN SHAFTS



THE PRO ONES ARE REALIZED WITH THE BEST HARD ROCK CANADIAN MAPLE WOOD, SELECTED BY VEINING, WEIGHT AND COLOUR.

PRO	REGULAR - D 12,8 mm
RING	IMAGO
TIP	Fuji Regular S
VP2™ 29'	26024

FIBER SHAFTS



PLAYING FIBRE TAKES YOUR GAME TO THE FUTURE. HIGHER REACTIVITY, UNDERFORMABLE AND LOW DEFLECTION ARE THE MAIN CHARACTERISTICS.

DIFFERENT NUMBER OF LAYERS AND MATERIALS MAKE THE FEELING DIFFERENT.

LUNA NERA	AMERICAN D. 12,4 mm	BREAK D. 12,8 mm T.B.D.
RING	Psx black	Psx black
TIP	Kamui classic M	Kamui original H
VP2™ 29'	24603	24605

LONGONI JOINT RANGE. CHOICE COMES FROM EXPERIENCE.



VP2 JOINT

In 2004, Longoni introduced the VP2 metal joint, universal for all Longoni cues. It has evolved from its predecessor, the Viper steel joint, which has proved itself in five-pin billiards. The object was to develop an ultra precise joint, fast of use and versatile for the various types of cues in the different disciplines: pool, five-pins, carom and Russian pyramid.

Since, the pins and shaft inserts of the VP2 joint have undergone multiple improvements, minding and ensuring compatibility:

Adjustment of the joint pin, after fabrication of the butt, for perfect alignment with the shaft insert;

Electro polishing of the joint's thread for the smoothest screw action;

Laser engraved numbering of each single joint pin to keep track of production quality and to counter plagiarism.

At present, the VP2 joint is also available in ultra light 'grade 5' titanium for cues which need such weight requirements and in stainless steel for all others, especially for five-pins. The shafts have brass or ergal – aluminium with magnesium – inserts. By choosing the perfect combination of materials, we ensure a perfect balance of the cue, for every billiards discipline and player.

The main characteristics of this joint are:

Fast and easy locking and unlocking;

Ultra firm lock for full energy transfer between butt and shaft;

Impervious to humidity;

Resistant to wear;

Ultra precise alignment of butt and shaft;

The cues with the VP2 joint have a forward balance in comparison to cues with wooden joints.

These joints can be easily retrofitted on old cues and models of other brands.

	VP2 Titanium pin	VP2 Steel pin	VP2 Brass insert	VP2 Ergal insert
Weight	18 gr ca.	32 gr ca.	13,3 gr ca.	4,4 gr ca.
Art.	3404	3403	3405	3499



WOODEN JOINT

The traditional Longoni wooden joint was introduced in the sixties when the production of Longoni two-piece cues began, essentially for the carom and five-pins game. The starting point for the development of this joint were the two-piece French 'Jolie' cues, appreciated at that time by many players, worldwide. Since, the Longoni wooden joint has become the standard, which quality the manufacturers around the world have been trying to match.

First, it was entirely handcrafted. From 2000, to ensure higher accuracy, CNC machinery was introduced. During fabrication of the joint, multiple control points apply for both butt and shaft threads to ensure a perfect lock and interchangeability. Recently, specialised gauges have been implemented to guarantee the constant quality all along the production process. Still, the last steps of polishing and quality control still require the final touch of our experienced craftsmen.

The main characteristics of the wooden joint are:

- A firm lock, yet natural feel of a one-piece cue;

- The cue has a smoother hit than with a metal joint;

- The cue gives the player maximum feedback about the hit of the ball;

- The cue is more flexible.

The wooden joint is to remain in the Longoni collection for future cues. Many pros - world champions - only want the Longoni wooden joint.





Vaula cues
Stecche Vaula



Pool

STARGATE

REAL CANADIAN MAPLE



VP25
INOXIDABLE PIN



IRISH LINEN



BLACK BAKELITE RING

VAULA POOL STARGATE-II 1 ART. 30052



VAULA POOL STARGATE-II 2 ART. 30053



VAULA POOL STARGATE-II 3 ART. 30054



VAULA POOL STARGATE-II 4 ART. 30055



DOTAZIONE/COMPLEMENTARY: 1 PUNTA ACERO CANADESE SELEZIONATO Ø12,8 MM / 1 SELECTED CANADIAN MAPLE SHAFT Ø12,8 MM



VAULA POOL FLAMINGO-II 1 ART. 30049



VAULA POOL FLAMINGO-II 2 ART. 30050



VAULA POOL FLAMINGO-II 3 ART. 30051



DOTAZIONE/COMPLEMENTARY: 1 PUNTA ACERO CANADESE SELEZIONATO Ø12,8 MM / 1 SELECTED CANADIAN MAPLE SHAFT Ø12,8 MM



Pool

FLAMINGO

REAL CANADIAN MAPLE



Westfalia
JOINT

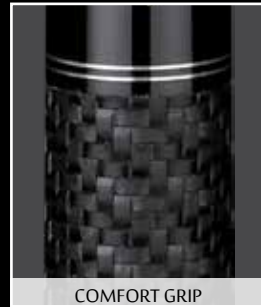

COMFORT GRIP



STAINLESS STEEL RING



Pool



REAL CANADIAN MAPLE



Westfalia JOINT

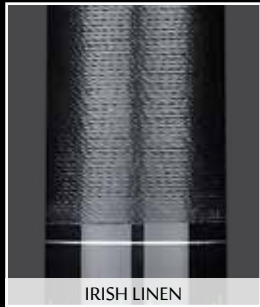

IRISH LINEN



PVC RING

VAULA POOL BISON-II 1 ART. 30045



VAULA POOL BISON-II 2 ART. 30046



VAULA POOL BISON-II 3 ART. 30047



VAULA POOL BISON-II 4 ART. 30048



DOTAZIONE/COMPLEMENTARY: 1 PUNTA ACERO CANADESE SELEZIONATO Ø12.8 MM / 1 SELECTED CANADIAN MAPLE SHAFT Ø12.8 MM



VAULA POOL SUPERNOVA-II 1 ART. 30041



VAULA POOL SUPERNOVA-II 2 ART. 30042



VAULA POOL SUPERNOVA-II 3 ART. 30043



VAULA POOL SUPERNOVA-II 4 ART. 30044



DOTAZIONE/COMPLEMENTARY: 1 PUNTA ACERO CANADESE SELEZIONATO Ø12.8 MM / 1 SELECTED CANADIAN MAPLE SHAFT Ø12.8 MM



Pool



REAL CANADIAN MAPLE



Westfalia JOINT



MELANGE LINEN



PVC RING



Pool

Mark Eastwood

REAL CANADIAN MAPLE



VAULA POOL MARK EASTWOOD-II.1 ART. 30059



VAULA POOL MARK EASTWOOD-II.2 ART. 30062



VAULA POOL MARK EASTWOOD-II.3 ART. 30063



DOTAZIONE/COMPLEMENTARY: 1 PUNTA ACERO CANADESE SELEZIONATO Ø12,8 MM / 1 SELECTED CANADIAN MAPLE SHAFT Ø12,8 MM



VAULA CAROM BISON LIBRE-II.1 ART. 30064



VAULA CAROM BISON LIBRE-II.2 ART. 30065



DOTAZIONE/COMPLEMENTARY: 1 PUNTA ACERO CANADESE SELEZIONATO Ø11 MM / 1 SELECTED CANADIAN MAPLE SHAFT Ø11 MM



Carom



REAL CANADIAN MAPLE





Carom



REAL CANADIAN
MAPLE



VP25
INOXIDABLE PIN



SPORT GRIP



BLACK BAKELITE RING

VAULA CAROM BISON 3C-II 1 ART. 30066



VAULA CAROM BISON 3C-II 2 ART. 30067



VAULA CAROM BISON 3C-II 3 ART. 30068



DOTAZIONE/COMPLEMENTARY: 1 PUNTA ACERO CANADESE SELEZIONATO Ø12 MM / 1 SELECTED CANADIAN MAPLE SHAFT Ø12 MM



VAULA LASER 1 ART. 21018 (NORMAL VERSION) - ART. 21018P (PRO VERSION)



VAULA LASER 2 ART. 21019 (NORMAL VERSION) - ART. 21019P (PRO VERSION)



VAULA LASER 3 ART. 21020 (NORMAL VERSION) - ART. 21020P (PRO VERSION)



DOTAZIONE/
COMPLEMENTARY
"NORMAL VERSION"

1 PUNTA ACERO VAULA LASER /
1 MAPLE SHAFT VAULA LASER

DOTAZIONE/
COMPLEMENTARY
"PRO VERSION"

- 1 PUNTA ACERO VAULA LASER
/ 1 MAPLE SHAFT VAULA LASER
- 1 PUNTA FIBRA VAULA
SHADOW / 1 FIBER SHAFT
VAULA SHADOW
- 1 FODERO DUKE / 1 CUE BAG
DUKE



5
Birilli

"Laser" line



OMOLOGATA



VP25
INOXIDABLE PIN



SPORT GRIP



STAINLESS STEEL RING



5 Birilli

QUANTUM

"Pro" line



OMOLOGATA



VP25
INOXIDABLE PIN



DIAMOND GRIP



STAINLESS STEEL RING

VAULA 5 BIRILLI QUANTUM 1 ART. 30056 (NORMAL VERSION) - ART. 30056P (PRO VERSION)



VAULA 5 BIRILLI QUANTUM 2 ART. 30057 (NORMAL VERSION) - ART. 30057P (PRO VERSION)



VAULA 5 BIRILLI QUANTUM 3 ART. 30058 (NORMAL VERSION) - ART. 30058P (PRO VERSION)



DOTAZIONE/
COMPLEMENTARY
"NORMAL VERSION"

1 PUNTA ACERO CANADESE / 1
CANADIAN MAPLE SHAFT

DOTAZIONE/
COMPLEMENTARY
"PRO VERSION"

- 1 PUNTA ACERO CANADESE /
1 CANADIAN MAPLE SHAFT
- 1 PUNTA FIBRA SHADOW /
FIBER SHAFT SHADOW
- 1 FODERO DUKE / 1 CUE BAG
DUKE

PROLUNGA VAULA "ZERO" / EXTENSION VAULA "ZERO" ART. 14813



15,5 cm

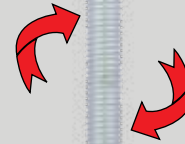

VIBRALESS



5 Birilli

QUANTUM

"Pro" line



OMOLOGATA

VIBRALESS

LA PRIMA STECCA ENTRY LEVEL
CON L'INNOVATIVO SISTEMA
DI PESI VIBRALESS SVILUPPATO
DAL TEAM LONGONI.

LE STECCHE VAULA QUANTUM
SONO FORNITE CON PUNTA IN
LEGNO E FIBRA IN UN PRATICO
FODERO.

PROLUNGA VAULA ZERO
ATTACCO VELOCE DISPONIBILE
COME OPTIONAL.





Pool line

**REAL CANADIAN
MAPLE**

COBRA 202
ART. 27200

COBRA 205
ART. 27201

COBRA 100
ART. 27202

COBRA 102
ART. 27203

COBRA 103
ART. 27204

COBRA 105
ART. 27205

*The bottom
line price
Linea primo
prezzo*

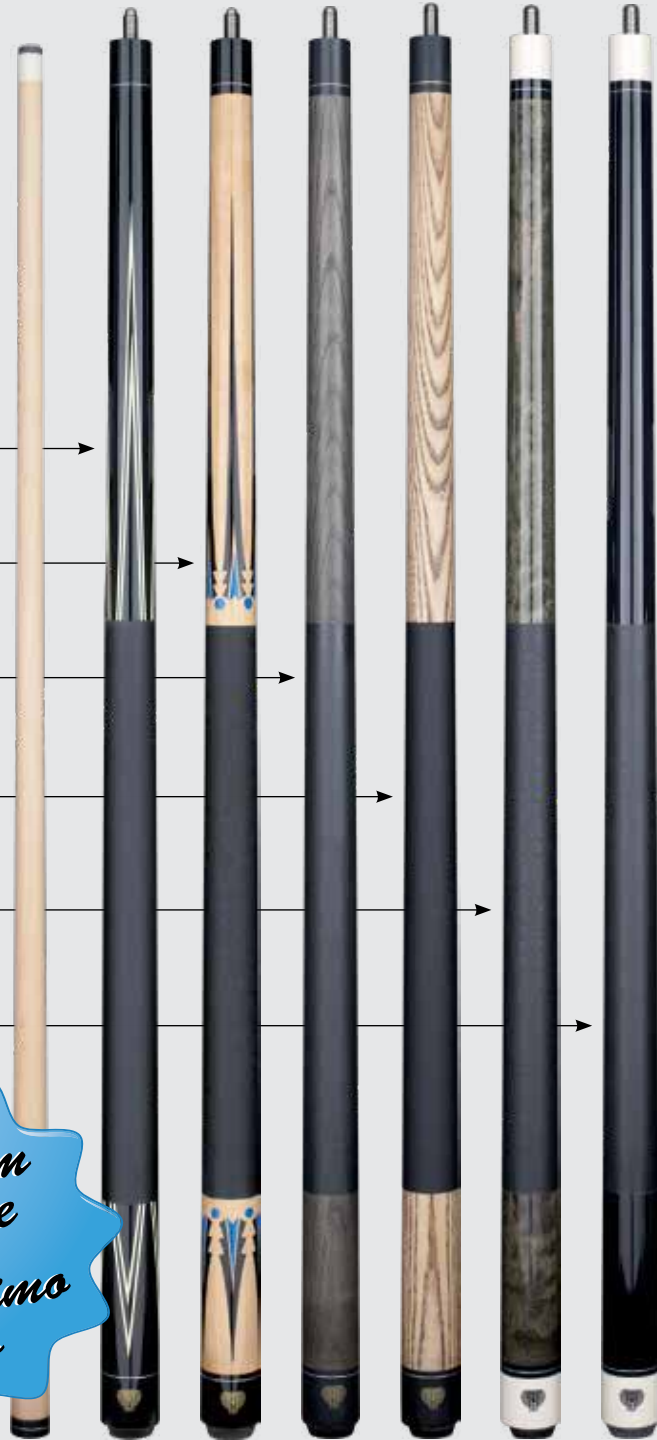

Jumpini

**REAL CANADIAN
MAPLE**

ART. 26070
STARGATE JUMP
147 cm

ART. 26071
STARGATE JUMP/BREAK
109 cm

ART. 25742
JUMP PEGASO POOL
107 cm

PUNTA ACERO PER STECCA VAULA "CLASSIC" LINE - COLLARE NERO / SHAFT MAPLE FOR CUE VAULA "CLASSIC" LINE - BLACK COLLAR ART. 21030



PUNTA ACERO PER STECCA VAULA "LASER" LINE - SILVER RING / SHAFT MAPLE FOR CUE VAULA "LASER" LINE - SILVER RING ART. 21060



PUNTA VAULA SHADOW VP2 730 PER STECCA VAULA "LASER" LINE / SHAFT VAULA SHADOW VP2 730 FOR CUE VAULA "LASER" LINE ART. 26091



PUNTA VAULA SHADOW VP2 700 PER STECCA VAULA "QUANTUM PRO" LINE / SHAFT VAULA SHADOW VP2 700 FOR CUE VAULA "QUANTUM PRO" LINE ART. 26270



FODERO VAULA NEOPRENE 1C/1P / CUE BAG VAULA NEOPRENE 1C/1P ART. 6400



PROLUNGA VAULA "ZERO" / EXTENSION VAULA "ZERO" ART. 14813



ART. 14710
PARACOLPO STECCA VAULA
RUBBER BUMPER CUE VAULA



BLACK SHARK Ø 14 mm

	soft	medium	hard
Art.	552	551	550



House cues
Stecche intere

Cassia wood

- ART. 17070
CPS BLACK / NERA
91 cm / 12 mm
- ART. 3484
CPS BLACK / NERA
110 cm / 12 mm
- ART. 22101R
CPS/48 BLACK / NERA
120 cm / 12 mm
- ART. 22102R
CPS/52 BLACK / NERA
130 cm / 12 mm
- ART. 22103R
CPS/57 BLACK / NERA
145 cm / 12 mm
- ART. 22103RE
CPS/57 ECO BLACK / NERA
145 cm / 12 mm
- ART. 22097R
CPS/57 RED / ROSSA
145 cm / 12 mm
- ART. 22098R
CPS/57 BLUE / BLU
145 cm / 12 mm
- ART. 22099R
CPS/57 BROWN / MARRONE
145 cm / 12 mm
- ART. 22100R
CPS/57 BURGUNDY / BORDEAUX
145 cm / 12 mm



Fiber cues

- ART. 22166
FIBERTECH ECO POOL
145 cm / 13 mm
- ART. 22059
FIBERTECH POOL
145 cm / 13 mm
- ART. 22130
FIBERTECH INTERNAZIONALE
142 cm / 12 mm
- ART. 25836
ELITE 5 BIRILLI
142 cm / 12 mm

POOL

HEIGHT / ALTEZZA 145 cm
FERRULE / GHIERA 30 mm
TIP / CUOIO 13 mm
WEIGHT / PESO 520 -590 gr

ART. 22431
MAHOGANY / MOGANO

ART. 22434
BLUE / BLU

ART. 22435
BROWN / MARRONE

ART. 22432
RED / ROSSA

ART. 22433
GREEN / VERDE

CAROM

HEIGHT / ALTEZZA 140 cm
FERRULE / GHIERA 20 mm
TIP / CUOIO 12 mm
WEIGHT / PESO 480 -560 gr

ART. 22496
MAHOGANY / MOGANO

INTERNAZIONALE

HEIGHT / ALTEZZA 140 cm
FERRULE / GHIERA 20 mm
TIP / CUOIO 12 mm
WEIGHT / PESO 620 -650 gr

ART. 22436
MAHOGANY / MOGANO

ART. 22439
BLUE / BLU

ART. 22440
BROWN / MARRONE

ART. 22437
RED / ROSSA

ART. 22438
GREEN / VERDE

ART. 22441
BLACK / NERO

ITALIANA

HEIGHT / ALTEZZA 144 cm
FERRULE / GHIERA 24 mm
TIP / CUOIO 14 mm
WEIGHT / PESO 680 -730 gr

ART. 22536
MAHOGANY / MOGANO

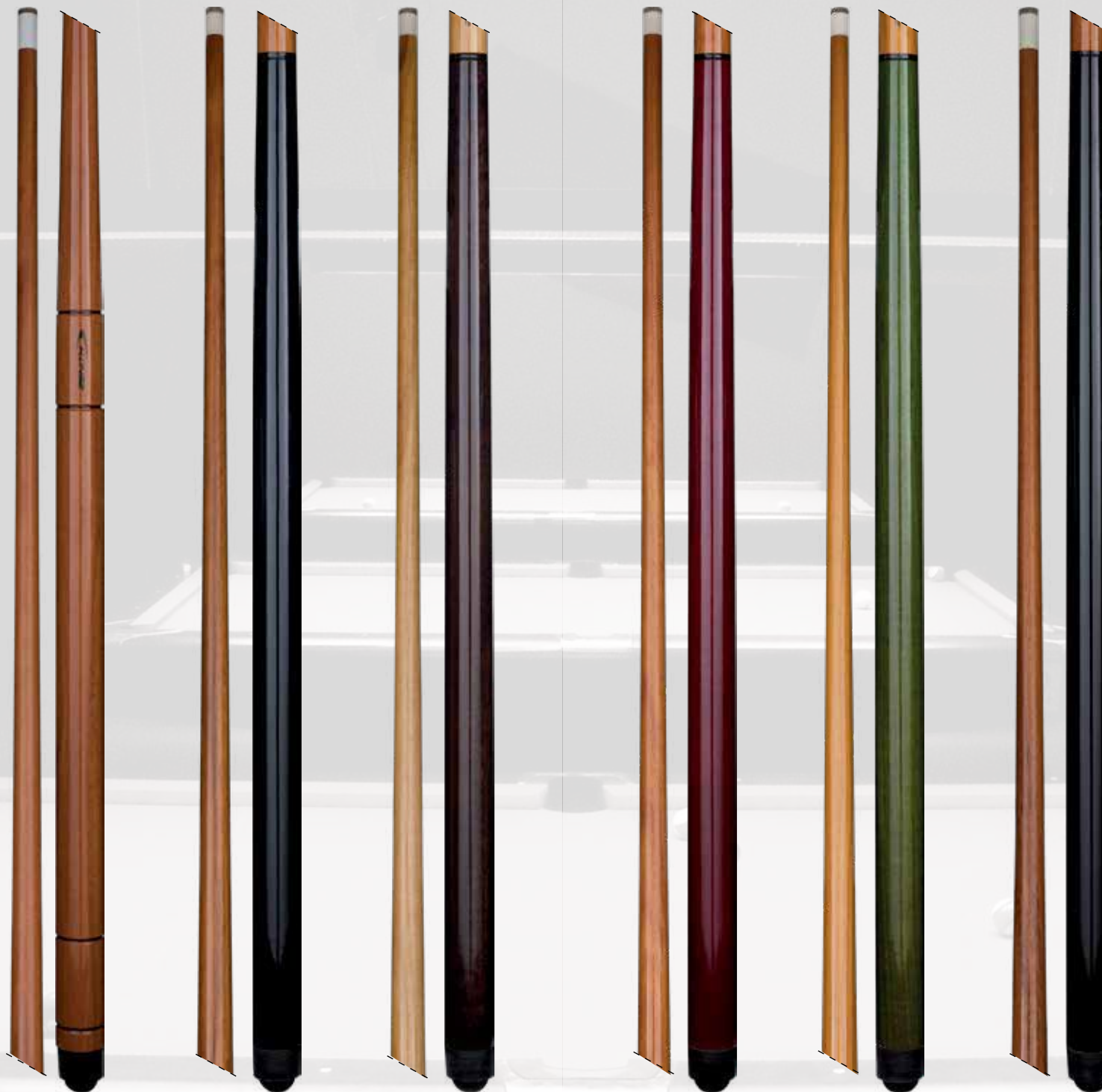

POOL

HEIGHT / ALTEZZA 144 cm
TIP / CUOIO 13 mm

ART. 25859
TORPEDO BLACK / NERO

INTERNAZIONALE

ART. 26802
TORPEDO ALL BLACK
122 cm / 12 mm

ART. 26800
TORPEDO ALL BLACK
132 cm / 12 mm

ART. 26805
TORPEDO ALL GREY
132 cm / 12 mm

ART. 26803
TORPEDO ALL WHITE
122 cm / 12 mm

ART. 26801
TORPEDO ALL WHITE
132 cm / 12 mm

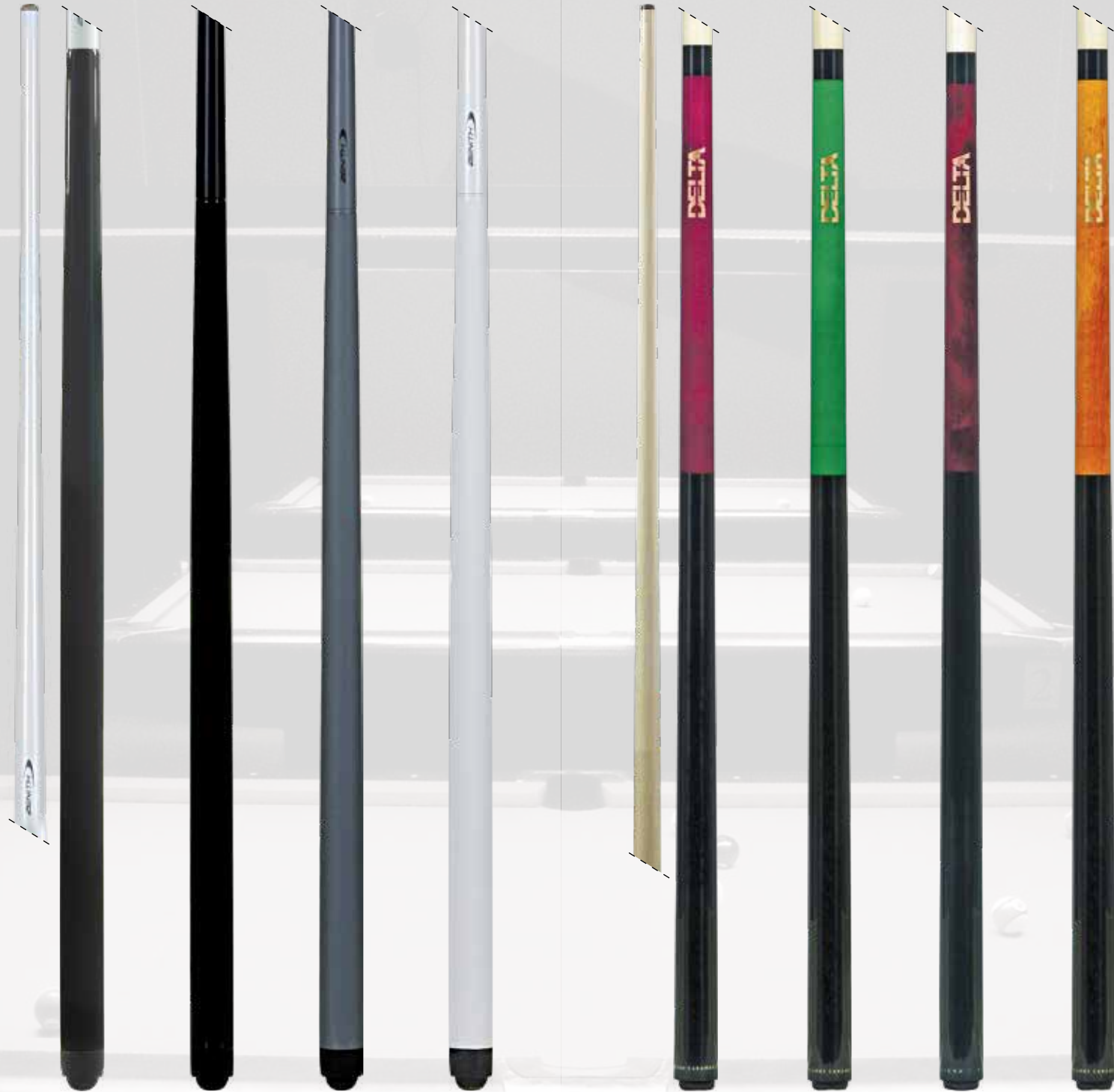

Maple cues

POOL

HEIGHT / ALTEZZA 145 cm
TIP / CUOIO 13 mm

ART. 22023
DELTA BURGUNDY / BORDEAUX

ART. 22024
DELTA GREEN / VERDE

ART. 22025
DELTA PURPLE / PORPORA

ART. 22026
DELTA ORANGE / ARANCIONE

CAROM

HEIGHT / ALTEZZA 140 cm
TIP / CUOIO 12 mm

ART. 25348
DELTA BURGUNDY / BORDEAUX

ART. 25349
DELTA GREEN / VERDE

ART. 25350
DELTA PURPLE / PORPORA

ART. 25351
DELTA ORANGE / ARANCIONE

INTERNAZIONALE

HEIGHT / ALTEZZA 143 cm
TIP / CUOIO 12 mm

ART. 25273
DELTA BURGUNDY / BORDEAUX

ART. 25274
DELTA GREEN / VERDE

ART. 25275
DELTA PURPLE / PORPORA

ART. 25276
DELTA ORANGE / ARANCIONE

Delta

Maple cues

ITALIANA (pag.191)

HEIGHT / ALTEZZA 143 cm

TIP / CUIOIO 14 mm

ART. 25269

DELTA BURGUNDY / BORDEAUX

ART. 25270

DELTA GREEN / VERDE

ART. 25271

DELTA PURPLE / PORPORA

3tt



ART. 24057

3TT POOL

145 cm / 13 mm

ART. 24057E

3TT POOL ECO

145 cm / 13 mm

RR
Mod. IMPERO



ART. 22998

IMPERO CARAMBOLA

140 cm / 11,5 mm

ART. 22910

IMPERO INTERNAZIONALE

144 cm / 12 mm

ART. 22997

IMPERO ITALIANA

143 cm / 14 mm

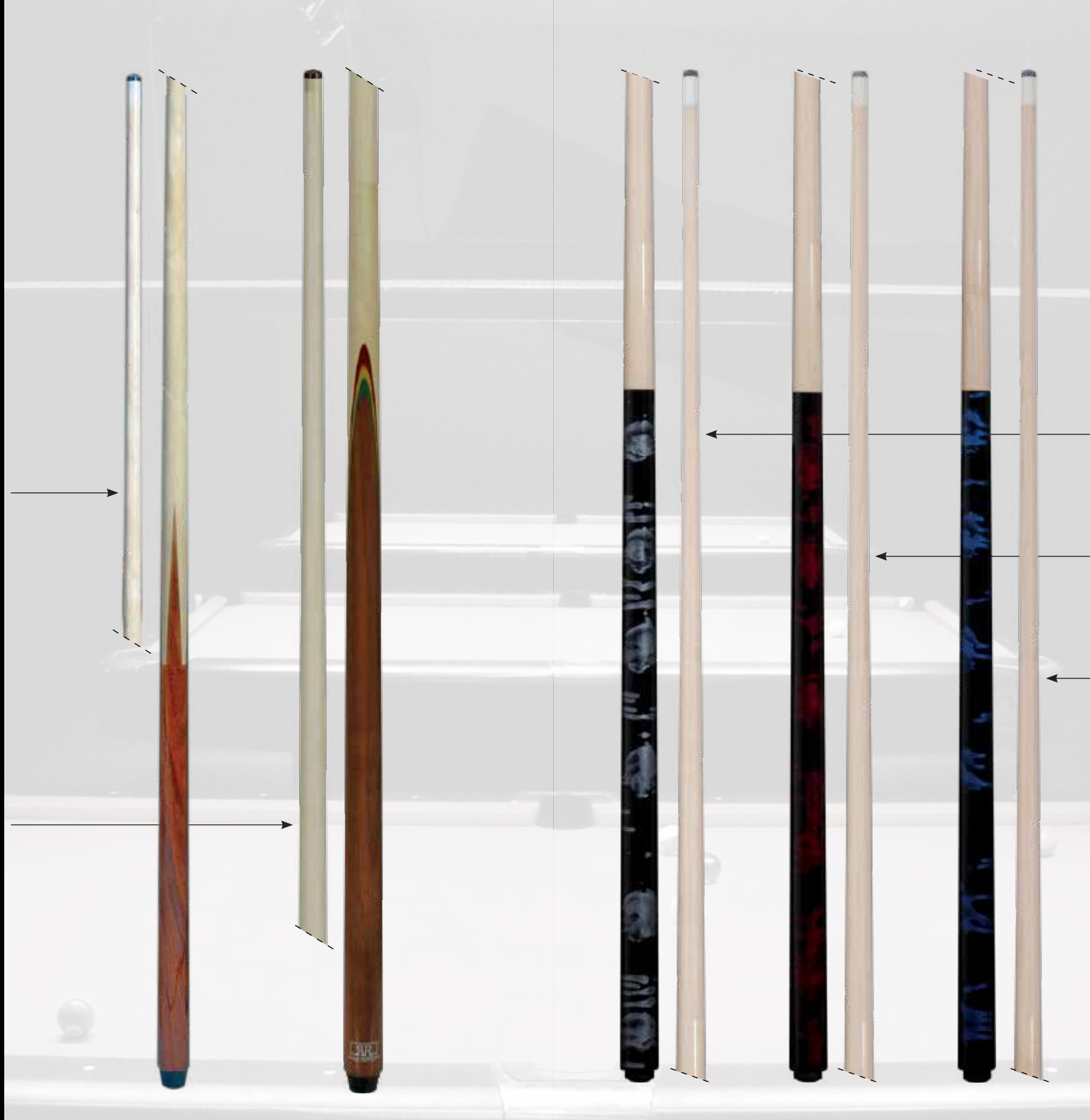

Saint Tropez

REAL CANADIAN MAPLE

VERO ACERO CANADESE

ART. 28200

SAINT TROPEZ GREY/GRIGIA

143 cm / 13 mm

ART. 28201

SAINT TROPEZ RED/ROSSA

143 cm / 13 mm

ART. 28202

SAINT TROPEZ BLUE/BLU

143 cm / 13 mm

ART. 4580
STECCA MANCHESTER
145 cm / 9 mm



ART. 25816
STECCA INFINITY
145 cm / 9 mm



ART. 25817
STECCA BIRMINGHAM
145 cm / 9 mm



ART. 22731
CUE BRIDGE LUX POOL CM 107
STECCA BRIDGE LUSSO POOL CM 107



ART. 22077
CUE RAMIN BRIDGE POOL CM145 Ø13
STECCA RAMIN BRIDGE POOL CM145 Ø13



ART. 27855
CUE BRIDGE CHROMED WITH HEAD CM146
STECCA BRIDGE ALLUMINIO CON STELLA BRIDGE CROMATA CM 146



ART. 27041
CUE BRIDGE RENZLINE TELESCOPIC
STECCA BRIDGE RENZLINE TELESCOPICA

143 mm

38 mm

ART. 25153-2
STECCHONE EASY SMONTABILE
185 cm / 12 mm

ART. 25154-2
STECCHONE EASY SMONTABILE
215 cm / 12 mm

ART. 24668
STECCHONE VECCHIO MOGANO
185 cm -12 - SMONTABILE

ART. 24669
STECCHONE VECCHIO MOGANO
215 cm -12 - SMONTABILE



Predator / Poison cues Stecche Predator / Poison



SP4 LWR
ART. 30020

SP4 NWR
ART. 30022

SP8 LWR
ART. 30023

SP8 NWR
ART. 30025



SPORT2
ART. 30034

SPORT2 ICE NW
ART. 30036

SPORT2 ICE SW
ART. 30035

SPORT EMBER NW
ART. 28131

SPORT EMBER SW
ART. 28132

SPORT2 STRATOS NW
ART. 23294

SPORT2 STRATOS SW
ART. 23295





P3 B NW
ART. 30017

P3 B LW
ART. 30018

9K-1
ART. 30070

9K-2
ART. 30071

9K-3
ART. 30072



THRONE 2-1
ART. 30005

THRONE 2-2
ART. 30009

THRONE 2-3
ART. 30010

THRONE 2-4
ART. 30011

THRONE 2-5
ART. 30012



BLAK4 1
ART. 28126

BLAK4 2
ART. 28127

BLAK4 3
ART. 28128

BLAK4 4
ART. 28129

BLAK4 5
ART. 28130



AIR2
ART. 28028

BK3 NW
ART. 30037

BK3 LW
ART. 30038

BK3 SW
ART. 30039

BK RUSH NW
ART. 28091

BK RUSH SW
ART. 28092



ARSENIC 3-1
ART. 28106

ARSENIC 3-2
ART. 28107

ARSENIC 3-3
ART. 28108

ARSENIC 3-4
ART. 28109

ARSENIC 3-5
ART. 28110

ARSENIC 3-6
ART. 28111



VX5 BREAK NERA
ART. 30073

VX5 BREAK BIANCA
ART. 30074

VX5 JUMP BREAK BLU
ART. 30075

VX5 JUMP BREAK VERDE
ART. 30076

VX5 JUMP BREAK ROSA
ART. 30077

VX5 JUMP BREAK ROSSA
ART. 30078

VX5 JUMP BREAK ARGENTO
ART. 30079





VANTAGE UNILOC SILVER
RING
ART. 23242

VANTAGE UNILOC THIN
COLLAR
ART. 23245

314-3/29" UNILOC SILVER
RING
ART. 28055

314-3/29" UNILOC THIN
COLLAR
ART. 28056

Z-3/29" UNILOC SILVER
RING
ART. 28057

Z-3/29" UNILOC THIN
COLLAR
ART. 23246

REVO 12.4 UNILOC
ART. 28099

REVO 12.4 RADIAL
ART. 28112

REVO 12.9 UNILOC
ART. 28098



ART	314-3
23249	314-3/29" 5/16-14 BLACK COLLAR
23278	314-3/29" 5/16-14 SILVER RING
28072	314-3 PARTIAL
23251	314-3/29" RADIAL THIN BLACK COLLAR
23282	314-3/29" UNILOC NO COLLAR
23280	314-3/30" RADIAL THIN BLACK COLLAR
23284	314-3/30" UNILOC SILVER RING

ART	Z3
23253	Z-3/29" 5/16-14 BLACK COLLAR
23279	Z-3/29" 5/16-14 SILVER RING
23254	Z-3/29" 5/16-18 BLACK COLLAR
28073	Z-3 PARTIAL
23252	Z-3/29" 5/16-14 BLACK COLLAR
23281	Z-3/30" RADIAL THIN BLACK COLLAR
23285	Z-3/30" UNILOC SILVER RING

ART	VANTAGE
28076	VANTAGE RADIAL THIN COLLAR



GHOST
ART. 24231

BULLET
ART. 24230



Longoni cue cases
Valigette Longoni

AFRICA

2 butts + 4 shafts + 2 extensions + spares
2 calci + 4 punte + 2 prolunghe + accessori



CERTILOGO

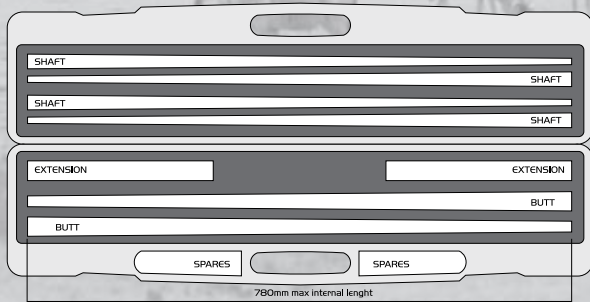

item / articolo	201526L
weight / peso	2,5 kg
max internal length / lunghezza massima interna	780 mm
external size / misura esterna	815 x 210 x 95 mm
material / materiale	Abs with leather / Abs con pelle
locks / serrature	2 combination locks / 2 serrature con combinazione

ANTARTIC

2 butts + 4 shafts + 2 extensions + spares
2 calci + 4 punte + 2 prolunghe + accessori



CERTILOGO

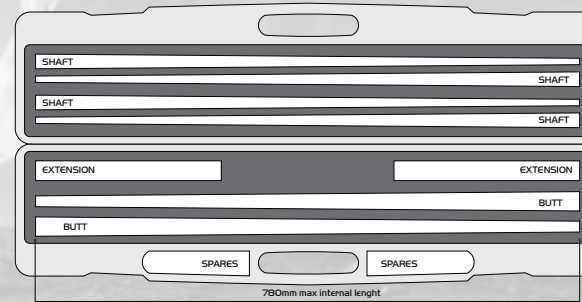

item / articolo	201527L
weight / peso	2,5 kg
max internal length / lunghezza massima interna	780 mm
external size / misura esterna	815 x 210 x 95 mm
material / materiale	Abs with leather / Abs con pelle
locks / serrature	2 combination locks / 2 serrature con combinazione

MONTECARLO

2 butts + 4 shafts + 2 extensions + spares
2 calci + 4 punte + 2 prolunghe + accessori



CERTILOGO

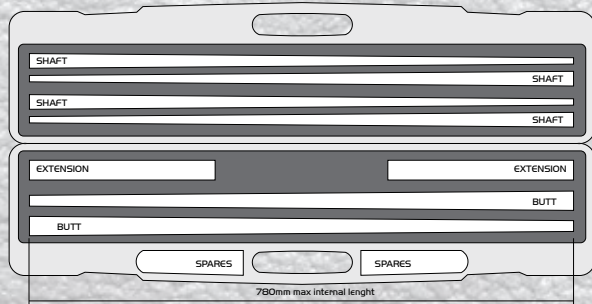

item / articolo	201567L
weight / peso	2 kg
max internal length / lunghezza massima interna	780 mm
external size / misura esterna	815 x 210 x 95 mm
material / materiale	Abs with leather / Abs con pelle
locks / serrature	2 combination locks / 2 serrature con combinazione

ONTARIO

2 butts + 4 shafts + 2 extensions + spares
2 calci + 4 punte + 2 prolunghe + accessori



CERTILOGO

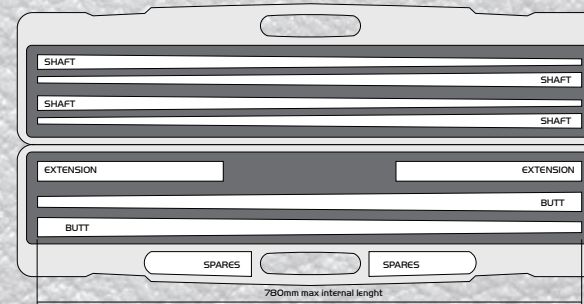

item / articolo	201568L
weight / peso	2 kg
max internal length / lunghezza massima interna	780 mm
external size / misura esterna	815 x 210 x 95 mm
material / materiale	Abs with leather / Abs con pelle
locks / serrature	2 combination locks / 2 serrature con combinazione

LONDRA

2 butts + 4 shafts + 2 extensions + spares
2 calci + 4 punte + 2 prolunghe + accessori



CERTILOGO

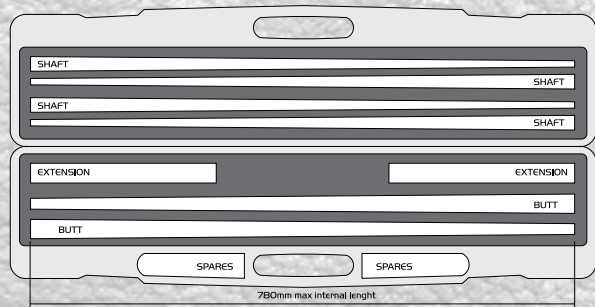

item / articolo	201569L
weight / peso	2,6 kg
max internal length / lunghezza massima interna	780 mm
external size / misura esterna	815 x 210 x 95 mm
material / materiale	Abs with leather / Abs con pelle
locks / serrature	2 combination locks / 2 serrature con combinazione

CALIFORNIA

2 butts + 4 shafts + 2 extensions + spares
2 calci + 4 punte + 2 prolunghe + accessori



CERTILOGO

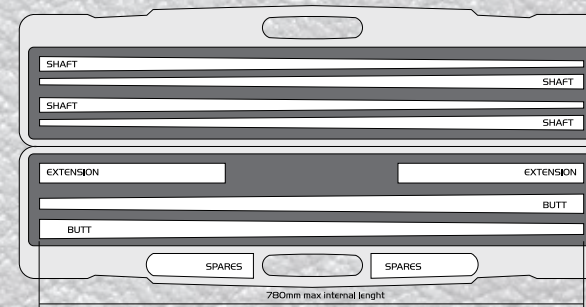

item / articolo	201566L
weight / peso	2,2 kg
max internal length / lunghezza massima interna	780 mm
external size / misura esterna	815 x 210 x 95 mm
material / materiale	Abs with leather / Abs con pelle
locks / serrature	2 combination locks / 2 serrature con combinazione

AVANT BLACK ABS

2 butts + 4 shafts + 2 extensions + spares
2 calci + 4 punte + 2 prolunghe + accessori



CERTILOGO

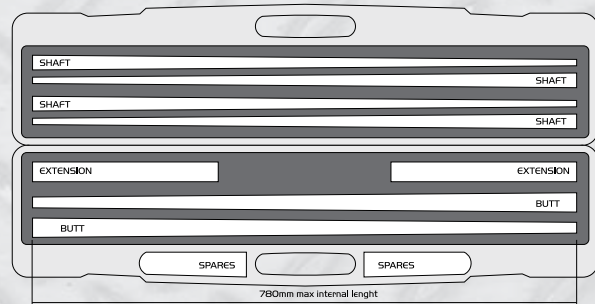

item / articolo	202102L
weight / peso	2,5 kg
max internal length / lunghezza massima interna	780 mm
external size / misura esterna	815 x 210 x 95 mm
material / materiale	Abs with leather / Abs con pelle
locks / serrature	2 combination locks / 2 serrature con combinazione

AVANT ALUMINIUM ABS

2 butts + 4 shafts + 2 extensions + spares
2 calci + 4 punte + 2 prolunghe + accessori



CERTILOGO

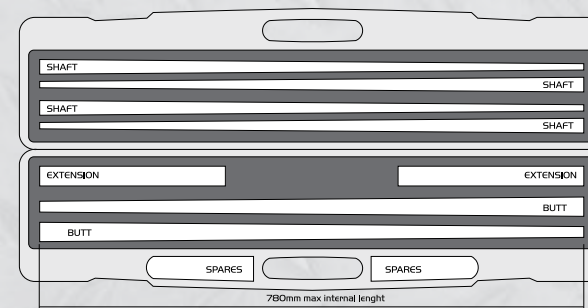

item / articolo	202100L
weight / peso	2,3 kg
max internal length / lunghezza massima interna	780 mm
external size / misura esterna	815 x 210 x 95 mm
material / materiale	Abs
locks / serrature	2 combination locks / 2 serrature con combinazione

DIABLO

2 butts + 4 shafts + 2 extensions + spares
2 calci + 4 punte + 2 prolunghe + accessori



CERTILOGO

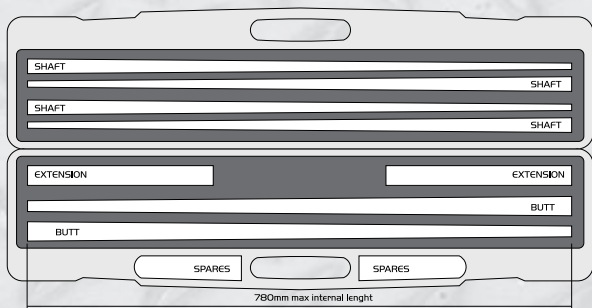

item / articolo	201525L
weight / peso	2,3 kg
max internal length / lunghezza massima interna	780 mm
external size / misura esterna	815 x 210 x 95 mm
material / materiale	Abs with leather / Abs con pelle
locks / serrature	2 combination locks / 2 serrature con combinazione



SULTAN

2butts + 4shafts + 2extensions + spares



Sultan

CERTILOGO

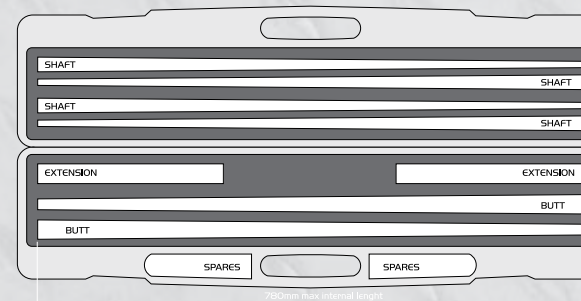

item / articolo	201571L
weight / peso	2,5 kg
max internal length / lunghezza massima interna	780 mm
external size / misura esterna	815 x 210 x 95 mm
material / materiale	Abs with leather / Abs con pelle
locks / serrature	2 combination locks / 2 serrature con combinazione



NOVECENTO

2 butts + 4 shafts + 2 extensions + spares
2 calci + 4 punte + 2 prolunghe + accessori



CERTILOGO

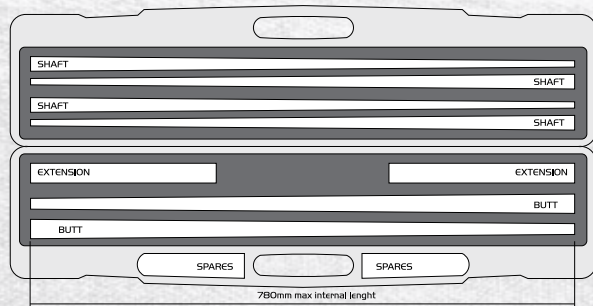

item / articolo	201574L
weight / peso	2 kg
max internal length / lunghezza massima interna	780 mm
external size / misura esterna	815 x 210 x 95 mm
material / materiale	Abs with rough and resistant textile/ Abs con tessuto resistente e dall'aspetto grezzo
locks / serrature	2 combination locks / 2 serrature con combinazione

LUX

2 butts + 4 shafts / 2 calci + 4 punte



CERTILOGO

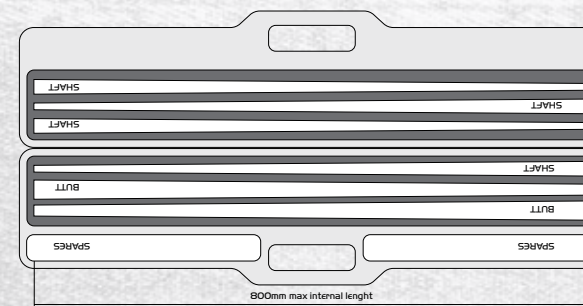

item / articolo	200509L
weight / peso	2 kg
max internal length / lunghezza massima interna	800 mm
external size / misura esterna	820 x 195 x 80 mm
material / materiale	Abs with leather / Abs con pelle
locks / serrature	2 combination locks / 2 serrature con combinazione

SOYUZ ABS WITH LEATHER

1 butt + 2 shafts + spares (for Russian pyramid only)
1 calcio + 2 punte + accessori (solo per pyramide russa)



CERTILOGO

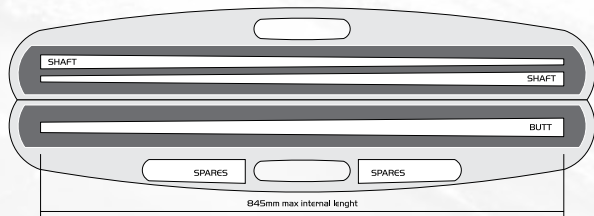

item / articolo	201531L
weight / peso	1,5 kg
max internal length / lunghezza massima interna	845 mm
external size / misura esterna	880 x 140 x 85 mm
material / materiale	Abs with leather / Abs con pelle
locks / serrature	1 combination lock + 2 normal lock / 1 serratura con combinazione + 2 serrature normali

COMPACT

1 butt + 2 shafts + spares / 1 calcio + 2 punte + accessori



CERTILOGO

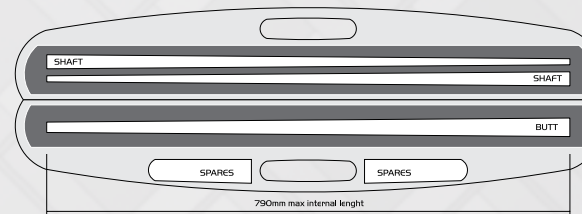

item / articolo	201564L
weight / peso	1,4 kg
max internal length / lunghezza massima interna	790 mm
external size / misura esterna	830 x 140 x 85 mm
material / materiale	Abs with leather / Abs con pelle
locks / serrature	1 combination lock + 2 normal locks / 1 serratura con combinazione + 2 serrature normali

SHUTTLE

1 butt + 2 shafts + 2 extensions / 1 punta + 2 calci + 2 prolunghe



BLACK/NERA



SIENA



BEIGE

	POOL / CAROM / 5-SKITTLES	PYRAMID
weight/peso	0,9 kg	0,9 kg
max internal length/ lunghezza massima interna	820 mm	820 mm
external size/misura esterna	850 x 140 x 80 mm	850 x 140 x 80 mm
material/materiale	Polypropylene / polipropilene	Polypropylene/polipropilene
locks/serrature	4 plastic sliding locks/ 4 serrature in plastica scorrevoli	4 plastic sliding locks/ 4 serrature in plastica scorrevoli

	POOL / CAROM / 5-SKITTLES	PYRAMID
Black/Nera	201521L	201521LSR
Siena	201529L	-
Beige	201522L	201522LSR

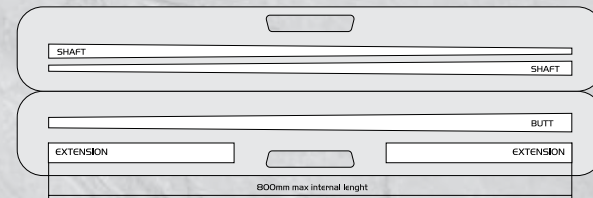

DOMY UNIVERSAL

(for Domy cues only / solo per stecche Domy)



CERTILOGO

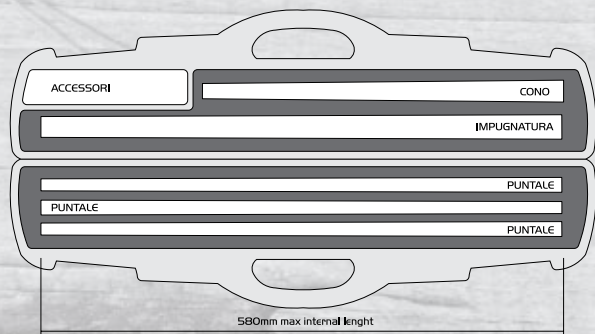

item / articolo	201528
weight / peso	1,5 kg
max internal length / lunghezza massima interna	580 mm
external size / misura esterna	620 x 210 x 80 mm
material / materiale	Abs with leather / Abs con pelle
locks / serrature	2 combination locks / 2 serrature con combinazione

TRANSPORTER

3 butts + 6 shafts + 4 extensions + spares
3 calci + 6 punte + 4 prolunghe + accessori



COMPETITIVE PRICE



item / articolo	201565L
weight / peso	1,5 kg
max internal length / lunghezza massima interna	780 mm
external size / misura esterna	800 x 250 x 60 mm
material / materiale	Polypropylene / polipropilene
locks / serrature	4 normal locks / 4 serrature normali

SKIPPER

2 butts + 4 shafts + 2 extensions + spares
2 calci + 4 punte + 2 prolunghe + accessori



CERTILOGO

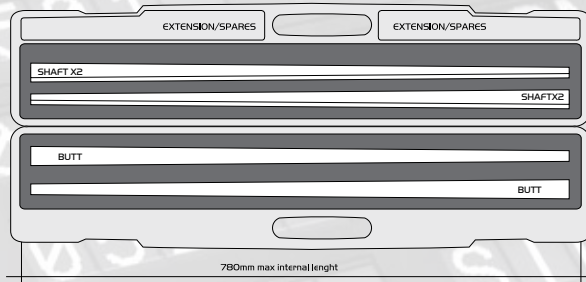

item / articolo	201572L
weight / peso	2,2 kg
max internal length / lunghezza massima interna	780 mm
external size / misura esterna	810 x 180 x 120 mm
material / materiale	Abs with leather / Abs con pelle
locks / serrature	3 combination locks / 3 serrature con combinazione

TRAVEL BAGS / FODERI DA VIAGGIO FOR LONGONI ABS CASES / PER VALIGETTE LONGONI ABS



Art. 6330
Travel bag "Frequent flyer" for cue cases. Maximum sizes 88 x 23 x 12 cm
Fodero "Frequent flyer" per valigette. Misure massime 88 x 23 x 12 cm



Art. 6276
Travel bag for cue case Longoni (2butts + 4shaft + 2 extensions + spare)
Fodero trasporta valigetta Longoni (2calci + 4punte + 2 prolunghe + accessori)



art. 6352
Lock chromed for Longoni case (1 pc)
Serratura a combinazione cromata per valigetta Longoni. (1pz)



art. 14650
Lock brushed nickel for Longoni cases (1 pc)
Serratura a combinazione nickel spazzolato per valigette Longoni (1pz)



art. 14652
Lock black for Longoni case (1 pc)
Serratura a combinazione nera per valigetta Longoni. (1pz)



art. 14651
Lock gold for Longoni cases (1 pc)
Serratura a combinazione dorata per valigetta Longoni (1pz)



Foam for Longoni cases internal part - complete set
Spugne per interno valigetta Longoni - set completo

ART	SIZE	SUITABLE FOR / ADATTO A
6364	1butt/2shafts - 1calcio/2punte	Compact line
6363	2butts/4shafts+2extensions - 2calci/4punte+2extensions	Avant / Explorer / Exclusive line
6279	2butts/4shafts - 2calci/2punte	Vintage line
6365	2butts/5shafts - 2calci/5punte	Avant line (previous edition/edizione precedente)
6354	3butts/6shafts+2extensions - 3calci/6punte+2extensions	Transporter



Cue cases & bags Valigette & foderi

Giotto

BILLIARTITALY

Longoni luxury cue bags

Giotto is the new cue bag by Longoni, completely in true leather and made in Italy. It is suitable for 5 pins, carom and pool cues. It is able to contain at least 4 butts, 8 shafts and several accessories.

- Variants: Dolcevita, Oceano, Essenza, Autunno, Doge.
- External size: 83x15x11 cm
- Useful maximal internal size: 78 cm
- Equipped with handle and shoulder strap
- External pockets for accessories with zip 10x34 cm and 10x24 cm
- Pockets for documents
- Weight: 2 kg
- Made in Italy

Giotto il nuovo fodero by Longoni in vera pelle, 100% made in Italy, adatto alle stecche da 5 birilli, carambola e pool. Può contenere fino a 4 calci, 8 punte e numerosi accessori.

- Versioni: Dolcevita, Oceano, Essenza, Autunno, Doge.
- Misura esterna: 83x15 x11h. cm
- Misura interna massima utile: 78 cm.
- Dotata di maniglia e tracolla.
- Tasche esterne per accessori con cerniera lampo 10x34 cm e 10x24 cm.
- Tasca documenti 13x15 cm.
- Peso: 2 kg.
- Made in Italy.



"Dolcevita"

Art. 6398



"Oceano"

Art. 6395



"Essenza"

Art. 6397



"Autunno"

Art. 6384



"Doge"

Art. 6452



LONGONI

AS SEEN ON

**You
Tube**

LONGONICUES

CERTILOGO

"STELLA" CASES/VALIGETTE

Art. 6284
Cue case "STELLA", 1 butt/3shafts - Internal size 82 cm
Valigetta "STELLA", 1 calcio/3punte - Misura interna 82 cm



Art. 6289
Cue case "STELLA", 2butts/4shafts - Internal size 82 cm
Valigetta "STELLA", 2calcio/4punte - Misura interna 82 cm

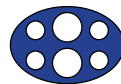

"FIRE" CASES/VALIGETTE

Art. 6284A
Cue case "FIRE" silver, 1butt/1shaft - Internal size 78 cm
Valigetta "FIRE" argento, 1 calcio/1 punta - Misura interna 78 cm



Art. 6284N
Cue case "FIRE" black, 1butt/1shaft - Internal size 78 cm
Valigetta "FIRE" nera, 1 calcio/1 punta - Misura interna 78 cm



"SPORT" CASES/VALIGETTE

Art. 6286N
Cue case "SPORT" black, 1butt/1shaft - Internal size 78 cm
Valigetta "SPORT" nera, 1 calcio/1 punta - Misura interna 78 cm



FODERO KC NERO 2C-4P

Art. 6277



- Rigid black cue bag in simil leather
- Size : 82 x 17 x 11 cm
- Weight :2,2 kg.
- Practical and comfortable handles shoulder for transport.
- Interiors made by black velcro with storage compartment.
- Four feet for self standing.
- Closure with zip.
- Suitable for pool and carom.
- Cues, shafts and accessories not included.

- Fodero rigido in simipelle nera.
- Dimensione: 82 x 17 x 11 cm.
- Peso: 2,2 kg.
- Pratici manici e comoda tracolla per il trasporto.
- Interni in velcro nero con vari porta oggetti.
- Dotato di 4 piedini per l'appoggio.
- Chiusura con cerniera.
- Per pool e per carambola.
- Stecche, puntali ed accessori non inclusi.

TITAN

Art. 3481
2 butts / 4 shafts - 2 calcio / 2 punte

760 mm - internal size / misura interna

350 mm



TITAN

Art. 3482
Special for 3pcs. cue
Speciale per stecca 3 pezzi

630 mm - internal size / misura interna

330 mm



"BASIC" BAGS/FODERI (PADDED/IMBOTTITI)

Art. 6032
 Cue bag "BASIC" vinile, 1 butt/1 shaft - Internal size 76 cm
 Fodero "BASIC" vinilico, 1 calcio/1 punta - Misura interna 76 cm



Art. 6263
 Cue bag "BASIC" black, 1 butt/1 shaft - Internal size 77 cm
 Fodero "BASIC" nero, 1 calcio/1 punta - Misura interna 77 cm



Art. 6033
 Cue bag "BASIC", 1 butt/1 shaft - Internal size 77 cm
 Fodero "BASIC", 1 calcio/1 punta - Misura interna 77 cm



"PRINCE" BAGS/FODERI (PADDED/IMBOTTITI)

Art. 6264
 Cue bag "PRINCE" black, 1 butt/1 shaft - Internal size 84 cm
 Fodero "PRINCE" nero, 1 calcio/1 punta - Misura interna 84 cm



Art. 6265
 Cue bag "PRINCE" blue, 1 butt/1 shaft - Internal size 84 cm
 Fodero "PRINCE" blu, 1 calcio/1 punta - Misura interna 84 cm



Art. 6267
 Cue bag "PRINCE" gray, 1 butt/1 shaft - Internal size 84 cm
 Fodero "PRINCE" grigio, 1 calcio/1 punta - Misura interna 84 cm



Art. 6270
 Cue bag "PRINCE" gray, 1 butt/2 shafts - Internal size 84 cm
 Fodero "PRINCE" grigio, 1 calcio/2 punta - Misura interna 84 cm



Art. 6273
 Cue bag "PRINCE" black/red, 1 butt/2 shafts - Internal size 84 cm
 Fodero "PRINCE" nero/rosso, 1 calcio/2 punta - Misura interna 84 cm



Art. 6274
 Cue bag "PRINCE" black/blue, 1 butt/2 shafts - Internal size 84 cm
 Fodero "PRINCE" nero/blu, 1 calcio/2 punta - Misura interna 84 cm



"DUKE" BAGS/FODERI (PADDED/IMBOTTITI)

Art. 6331
 Cue bag "DUKE", 1 butt/2 shafts - Internal size 83 cm
 Fodero "DUKE", 1 calcio/2 punta - Misura interna 83 cm



"QUEEN" BAGS/FODERI (SYNTHETIC LEATHER/PELLE SINTETICA)

Art. 6064
 Cue bag "GEORGE" black, 2butts/4shafts - Internal size 78 cm
 Fodero "GEORGE" nero, 2calci/4punte - Misura interna 78 cm



Art. 6282
 Cue bag "FRED" brown, 4butts/8shafts - Internal size 80 cm
 Fodero "FRED" marrone, 4calci/8punte - Misura interna 80 cm



Art. 6281
 Cue bag "SIMON" black, 4butts/8shafts - Internal size 80 cm
 Fodero "SIMON" nero, 4calci/8punte - Misura interna 80 cm



"LONGONI" BAG/FODERI (PADDED/IMBOTTITI)

Art. 6043L
 Cue bag LONGONI "G"-BASIC, 1butt/1shaft - Internal size 80 cm
 Fodero LONGONI "G"-BASIC, 1calcio/1punta - Misura interna 80 cm



Art. 6045L
 Cue bag LONGONI "G"-PRO, 2butt/2shafts - Internal size 80 cm
 Fodero LONGONI "G"-PRO, 2calci/2punte - Misura interna 80 cm



"KING POOL" TUBES/TUBI (VINYL/VINILE)

Art. 20108
 Cue tube "KING LOUIS" black, 1butt/1shaft - Internal size 78 cm
 Tubo "KING LOUIS" nero, 1calcio/1punta - Misura interna 78 cm



Art. 20122
 Cue tube "REZLINE" black, 1butt/2shafts - Internal size 76 cm
 Tubo "REZLINE" nero, 1calcio/2punte - Misura interna 76 cm



Art. 20121
 Cue tube "REZLINE" black, 2butts/2shafts - Internal size 76 cm
 Tubo "REZLINE" nero, 2calci/2punte - Misura interna 76 cm



Art. 6329
 Cue tube "KING EDWARD" black, 3butts/6shafts - Internal size 86 cm
 Tubo "KING EDWARD" nero, 3calci/6punte - Misura interna 86 cm



IMPERIAL

TUBES/TUBI (VINYL/VINILE)

Black Lady



Art. 6334
Cue tube "BLACK LADY",
1 butt/2shafts - Internal size 83 cm
Tubo "BLACK LADY",
1 calcio/2punte - Misura interna 83 cm



Art. 6340
Cue tube "BLACK LADY",
2butts/4shafts - Internal size 83 cm
Tubo "BLACK LADY",
2calci/4punte - Misura interna 83 cm



Art. 6341
Cue tube "BLACK LADY",
3butts/6shafts - Internal size 83 cm
Tubo "BLACK LADY",
3calci/6punte - Misura interna 83 cm

Moon Victory



Art. 6342
Cue tube "MOON VICTORY",
1 butt/2shafts - Internal size 83 cm
Tubo "MOON VICTORY",
1 calcio/2punte - Misura interna 83 cm

Sun Victory



Art. 6344
Cue tube "SUN VICTORY",
1butt/2shafts - Internal size 83 cm
Tubo "SUN VICTORY",
1 calcio/2punte - Misura interna 83 cm



Art. 6345
Cue tube "SUN VICTORY",
3butts/6shafts - Internal size 83 cm
Tubo "SUN VICTORY",
3calci/6punte - Misura interna 83 cm

CHARLIE

POOL CUE TUBE

The CHARLIE cue case will carry safely your cues to all your tournaments. It hosts up to 3 butts and maximum 5 shafts.

Additional pockets to offer enough storage space for all your accessories. The case features a special base construction, converting the case in your personal cuerack. An outstanding product in the choice of materials and finish.

Il fodero CHARLIE porta con cura le tue stecche ad ogni campionato. Può contenere 3 calci ed un massimo di 5 punte. E' dotato anche di ulteriori tasche che permettono di avere spazio anche per altri accessori di gioco. Il fodero ha una speciale base che lo converte in un portastecche personale. Un prodotto rivoluzionario nella scelta dei materiali e delle finiture.

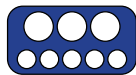

Art. 6280P
Cue tube "CHARLIE PRO",
3butts/5shafts
Internal size 81 cm

Tubo "CHARLIE PRO",
3calci/5punte
Misura interna 81 cm



URBAIN

SERIE (VINYL / VINILE)



2x4 SOFT
Grey version
Versione grigia



2x4 HARD
Red version
Versione rossa



3x5 HARD
Blue version
Versione blu

Cue bag Predator "URBAIN" / Fodero Predator "URBAIN"

	GREY - GRIGIO	RED - ROSSO	BLUE - BLU
2X4 SOFT	6385	6386	6387
2X4 HARD	6388	6389	6390
3X5 HARD	6391	6392	6393



ROADLINE
SERIE (VINYL / VINILE)



Cue bag Predator "ROADLINE" HARD / Fodero Predator "ROADLINE" HARD

	BLUE/WHITE - BLU/BIANCO	BURGUNDY/WHITE - BORDEAUX/BIANCO	BLACK/BEIGE - NERO BEIGE
2X2	6426	6434	6430
2X4	6427	6435	6431
3X5	6428	6436	6432
4X8	6429	6437	6433



SPORT
SERIE (VINYL / VINILE)



Art. 6374
Cue bag Predator "SPORT HARD", black
2butts/4shafts - Internal size 83 cm
Fodero Predator "SPORT HARD", nero
2calci/4punte - Misura interna 83 cm



Art. 6373
Cue bag Predator "SPORT HARD", yellow
2butts/4shafts - Internal size 83 cm
Fodero Predator "SPORT HARD", giallo
2calci/4punte - Misura interna 83 cm



Art. 6372
Cue bag Predator "SPORT SOFT", black
1butt/1shaft - Internal size 83 cm
Fodero Predator "SPORT SOFT", nero
1calcio/1punta - Misura interna 83 cm



Art. 6371
Cue bag Predator "SPORT SOFT", black
3butts/4shafts - Internal size 83 cm
Fodero Predator "SPORT SOFT", nero
3calci/4punte - Misura interna 83 cm



Art. 6375
Cue bag Predator "SPORT SOFT", yellow
3butts/4shafts - Internal size 83 cm
Fodero Predator "SPORT SOFT", giallo
3calci/4punte - Misura interna 83 cm





Art. 6377
Cue tube Poison "ARMOR 1x1", black
1butt/1shaft - Internal size 83 cm

Fodero Poison "ARMOR 1x1", nero
1calcio/1punta - Misura interna 83 cm



Art. 6378
Cue tube Poison "ARMOR 2x4", black
2butts/4shafts - Internal size 83 cm

Tubo Poison "ARMOR 2x4", nero
2calci/4punte - Misura interna 83 cm

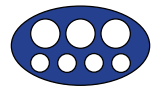

Art. 6379
Cue bag Poison "ARMOR 3x4", yellow
3butts/4shafts - Internal size 83 cm

Fodero Poison "ARMOR 3x4", giallo
3calci/4punte - Misura interna 83 cm



Cues accessories Accessori steccche

FUJI

THE LAMINATED PRO TIP

Fuji is the line of the professional laminated tips for the most exigent billiard players looking for performances and durability. Made of 10 layers of selected pig skin, Fuji can be easily installed on any top brand shaft. For the best result use only Longoni 977 professional glue.

I Fuji sono una gamma di cuoi professionali performanti e durevoli, una soluzione che soddisferà i giocatori più esigenti. Composti da 10 strati di pelle suina selezionata, i Fuji possono essere facilmente installati sulle stecche da biliardo delle migliori marche: per un miglior risultato usate unicamente colla Longoni 977.

Ten layers
Dieci strati



THE LAMINATED
PRO TIP

10 LAYERS

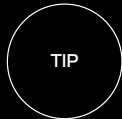

by

LONGONI
SINCE 1945

WWW.FUJITIPS.COM

FUJI BLACK

Maximum grip on the cue ball.
Massima tenuta sulla bilia.



FUJI MODENA

Higher speed to cue ball with more spin.
Maggiore velocità e maggiore spinta della bilia.



FUJI SULTAN

Maximum precision and playability.
Massima precisione e giocabilità

FUJI REGULAR

Perfect control on the cue ball.
Controllo perfetto sulla bilia.

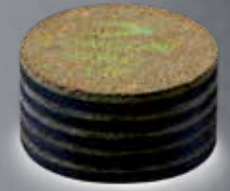

FUJI CAMOGLI

A combo experience of grip and control
on the cue ball.
Una esperienza combinata di tenuta e
controllo sulla bilia.

HARDNESS	DIAM	BLACK	REGULAR	CAMOGLI	MODENA	SULTAN
SOFT	Ø 14	430	403	442	446	507
MEDIUM	Ø 14	431	413	443	445	506
HARD	Ø 14	432	414	444	447	504

All codes refer to the unit price. / Tutti i codici si riferiscono al singolo pezzo.

All codes refer to the unit price. / Tutti i codici si riferiscono al singolo pezzo.



Since 2007, DaVinci is the official tip used by Longoni for maple shafts. Thanks to the quality of the leather and the competitive price it is the right product for everyone. Every single piece is inspected before being packed into the sealed bag.

A partire dal 2007, "DaVinci" è il cuoio ufficiale utilizzato dal brand Longoni per le punte in acero. Grazie alla qualità della pelle ed anche al suo prezzo competitivo, il cuoio "DaVinci" è il prodotto giusto per chiunque. Ogni singolo prodotto viene controllato prima di essere imballato nella propria confezione.



DA VINCI			
	soft	medium	hard
Ø 12 mm	423	415	-
Ø 13 mm	421	420	422
Ø 14 mm	425	401	402
Ø 16 mm	454	-	-

PREMIUM QUALITY LAMINATED TIPS

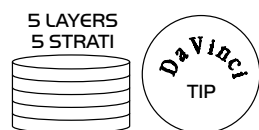

All codes refer to the unit price. / Tutti i codici si riferiscono al singolo pezzo.



BLACK SHARK Ø 14 mm				
	soft	medium	hard	
Art.	552	551	550	5 LAYERS 5 STRATI



Kamui CLEAR BLACK Ø 14 mm				
	super soft	soft	medium	hard
Art.	474	475	473	476

Kamui CLEAR ORIGINAL Ø 14 mm				
	super soft	soft	medium	hard
Art.	477	478	479	485

All codes refer to the unit price. / Tutti i codici si riferiscono al singolo pezzo.



Laminated tip, 100% pigskin
High porosity: more grip of the chalk to the tip
High quality and performance tip

Cuoio multistrato, 100% pelle di suino
Alta porosità: più aderenza del gesso al cuoio
Alto grado di qualità e performance

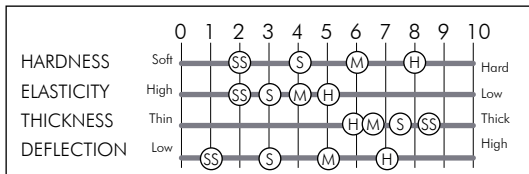

Kamui Black				
	super soft	soft	medium	hard
Art. Ø 12 mm	486	487	488	-
Art. Ø 14 mm	467	468	469	471

50 pcs. for box / 50 pz. per conf.

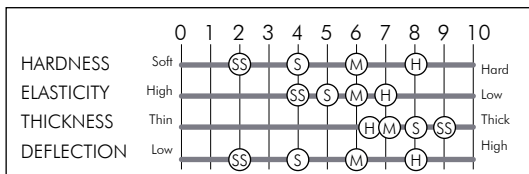

Kamui Ø 14 mm				
	super soft	soft	medium	hard
Art.	464	465	466	470

50 pcs. for box / 50 pz. per conf.

All codes refer to the unit price. / Tutti i codici si riferiscono al singolo pezzo.



Cue tip Blu soft - 5 pcs. per box
Cuoio Blu soft - 5 pz. per conf.

Ø	14
Art.	427



Cue tip Crystal - 5 pcs. per box
Cuoio Crystal - 5 pz. per conf.

Ø	13	14
Art.	456	429



Cue tip Break It - 5 pcs. per box
Cuoio Break It - 5 pz. per conf.

Ø	14
Art.	193



Cue tip Moori - 60 pcs. per box
Cuoio Moori - 60 pz. per conf.

	Medium
Ø 14	185

All codes refer to the unit price. / Tutti i codici si riferiscono al singolo pezzo.



Cue tip Predator - 1 pc. per box
Cuoio Predator - 1 pz. per conf.

	Soft	Medium	Hard
Ø 14	480	481	482

 aramith®



Cue tip Aramith - laminated
Cuoio Aramith - laminato

	Soft	Medium	Hard
Ø 13	460	459	458
Ø 14	463	462	461

NAVIGATOR
Japan



Made in Japan

ALPHA SERIES



	SX	S	M	H
Ø 14	496	497	498	499

BLACK SERIES



	SX	M	H
Ø 14	500	502	503



Cue tip Navigator - 10 pcs. per box
Cuoio Navigator - 10 pz. per conf.

RENZLINE

Otello
Professional Cue Tip



Water buffalo
Bufalo d'acqua.



Cue tip Otello - 50 pcs. per box
Cuoio Otello - 50 pz. per conf.

Ø	12,5
Art.	417

All codes refer to the unit price. / Tutti i codici si riferiscono al singolo pezzo.

All codes refer to the unit price. / Tutti i codici si riferiscono al singolo pezzo.



Ø	14
Art.	448

Cue tip Water Buffalo black
Cuoio Water Buffalo nero



Ø	14
Art.	453

Cue tip Water Buffalo natural
Cuoio Water Buffalo natural



Cue tip Le Professional - 50 pcs. per box
Cuoio Le Professional - 50 pz. per conf.

Ø	10	10.5	11	11.5	12
Art.	46	24	25	26	27
Ø	12.5	13	13.5	14	
Art.	44	45	47	139	



Cue tip Elk Master - 50 pcs. per box
Cuoio Elk Master - 50 pz. per conf.

Ø	9	10	10.5	11	11.5	12
Art.	174	175	131	132	176	135
Ø	12.5	13	13.5	14	14.5	
Art.	150	140	151	138	160*	

* 40 pcs. per box / 40 pz. per conf.



Cue tip Triumph - 50 pcs. per box
Cuoio Triumph - 50 pz. per conf.

Ø	12	12.5	13
Art.	405	406	407



Cue tip Hi-Chrome - 50 pcs. per box
Cuoio Hi-Chrome - 50 pz. per conf.

Ø	10	12
Art.	400	404



Cue tip Triangle - 50 pcs. per box
Cuoio Triangle - 50 pz. per conf.

Ø	10	11	12	12.5
Art.	200	201	202	205
Ø	13	13.5	14	
Art.	203	206	204	

TRADITIONAL CUE TIPS / CUOI TRADIZIONALI



Cue tip standard - 100 pcs. per box
Cuoi standard - 100 pz. per conf.

Ø	10	11	11.5	12	12.5	13
Art.	18	1	19	2	23	3
Ø	13.5	14	14.5	15	15.5	16
Art.	43	4	17	5	6	7



Art. 192
Linen phenolic tip Ø 14 mm
Cuoi fenolico Ø 14mm



Ø	10	10.5	11
Art.	300251	300344	300149
Ø	11.5	12	12.5
Art.	300253	300250	300254
Ø	13	13.5	14
Art.	300255	300256	300257

Push'on tip "Easy" - 100 pcs. per box
Cuoi a pressione "Easy" - 100 pz. per conf.



Ø	12	13	14
Art.	7052	7022	7060

Ferrule with glued tips - 100 pcs. per box
Ghiera con cuoi incollato - 100 pz. per conf.

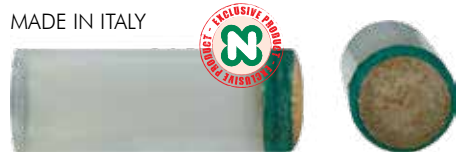

Ø	10	10.5	11	11.5	12
Art.	50	51	52	53	54
Ø	12.5	13	13.5	14	14.5
Art.	55	56	57	58	59
Ø	15	15.5	16		
Art.	60	61	62		

Clear Push'on tips with green line -100 pcs. per box
Cuoi a pressione con linea verde - 100 pz. per conf.



Ø	10	10.5	11	11.5	12
Art.	30	31	32	33	34
Ø	12.5	13	13.5	14	14.5
Art.	35	36	37	38	39
Ø	15	15.5	16		
Art.	40	41	42		

Push'on tips white - 100 pcs. per box
Cuoi a pressione bianchi - 100 pz. per conf.

SCREW ON TIPS / CUOI A VITE



100 pcs per box - 100 pz. per conf.

"UNIVERSAL" FERRULE GHIERA A VITE, CUIO UNIVERSALE
Ø 16 3/16"
7043



100 pcs per box - 100 pz. per conf.

PLASTIC SCREW FERRULE GHIERA CUIO A VITE PLASTICA	
Ø 11 6MA	Ø 12 8MA
7030	7031



Plastic screw - 500 pcs per box
Vite plastica - 500 pz. per conf.

8/MA EASY	
Ø 12 mm	64



Brass screw - 100 pcs per box
Vite ottone - 100 pz. per conf.

"EASY"	
Ø 11 5/MA	Ø 12 5/MA
68	300422

MADE IN ITALY



Plastic screw - 100 pcs per box
Vite plastica - 100 pz. per conf.

PLASTIC FERRULE GHIERA IN PLASTICA	
Ø 12 8/MA	74

MADE IN ITALY

All codes refer to the unit price. / Tutti i codici si riferiscono al singolo pezzo.



The JBR ferrule is realized with an ultramodern thermoplastic material, especially studied for the billiard. Longoni technicians decided to replace the famous CBR2 material because of different reasons. JBR ferrules are more resistant to impacts and they have a smooth surface for a more impermeability to the chalk. They can be easily glued with the Longoni 977 glue and they have been tested and used by the PRO players in the game. The JBR ferrules are available in different sizes and lengths in order to be adjusted to every different Longoni shaft.

La ghiera JBR è realizzata con un materiale termoplastico ultramoderno studiato appositamente per il biliardo. I tecnici Longoni hanno deciso di sostituire il glorioso materiale CBR2 per diverse ragioni. Le ghiera JBR sono molto più resistenti agli urti, hanno una superficie liscia per una maggiore impermeabilità al gesso. Possono essere facilmente incollate usando la colla Longoni 977 e sono state testate e usate dai giocatori Pro nel gioco. Le ghiera JBR sono disponibili in diverse misure e lunghezze per essere adattate su ogni differente puntale Longoni.

UNIVERSAL STANDARDS

Art	Discipline	Ø D	Ø d	H
7282	POOL 13	13	8	26
7259	POOL 14	14	8	26
7281	PYRAMID 13	13	6	13
7258	PYRAMID 14	14	6	13
7268	CAROM 11	11	5	10
7257	CAROM 12	12	5	10
7280	CAROM 13	13	5	10

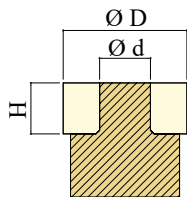

Suitable for from 11 mm to 15 mm diameter shafts.

Adatto a puntali con diametri tra 11 mm e 15 mm.

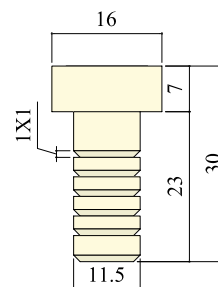

Art. 300098
Ferrule for Longoni fiber shafts, Ø 16 mm
Ghiera Longoni per puntali in fibra Ø 16 mm



LONGONI REPLACEMENT FERRULES

Art. 7343
FERRULE JBR POOL REGULAR AND AMERICAN
GHIERA JBR POOL REGULAR E AMERICAN

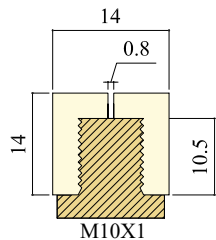

Art. 7312
FERRULE JBR POOL SLIM AND CAROM S30
GHIERA JBR POOL SLIM AND CAROM S30

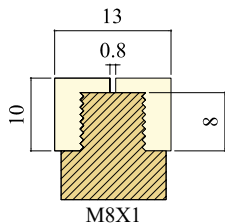

Art. 7290
FERRULE JBR POOL BREAK
GHIERA JBR POOL BREAK

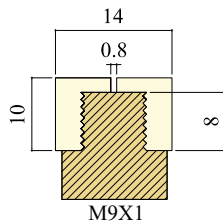

Art. 7345
FERRULE JBR "S2-S3-S5-S20" CAROM - 5 SKITTLES - WOOD - PRO SERIE (PRO, PRO2, PRO3, PRO4)
GHIERA JBR "S2-S3-S5-S20" CARAMBOLA - 5 BIRILLI - LEGNO - SERIE PRO (PRO, PRO2, PRO3, PRO4)

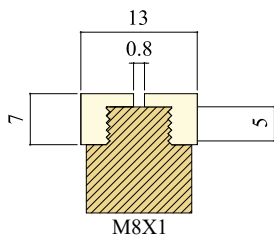

Plc ferrule / Ghiera in plc

Art	Discipline	h.	Ø D	Ø d
7140	pool	26	14	8



Plc ferrule / Ghiera in plc

Art	Discipline	h.	Ø D	Ø d
7144	carom	12	11,5	5
7137		12	12,5	5

SPECIAL FOR RUSSIAN PYRAMID
SPECIALE PER PIRAMIDE RUSSA



Ferrule white fiber vulcanized
Ghiera fibra bianca vulcanizzata

Art	Discipline	h.	Ø D	Ø d
F809	pyramid	19	14	7

MURANO

TRANSPARENT SILICONE HANDGRIP



Made in Italy

LONGONI
SINCE 1945

CERTILOGO

AS SEEN ON



LONGONICUES

Art. 18998

TECHNICAL NOTES:

weight: 28 gr
length: 340 mm
thickness: 1 mm

www.longonicues.com

CAROM HANDGRIPS / TUBOLARI

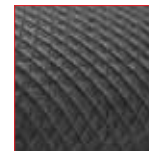

Length/lunghezza: 35,5 cm
Weight/peso: \cong 11 gr.
Thickness/spessore: 0,5 mm
Diam. 20/33 mm
Sold by piece/venduto al pz

texturized surface
superficie grecata

AS SEEN ON



LONGONICUES



art. 18041
Handgrip "X-Grip" black
Tubolare "X-Grip" nero



art. 18258
Handgrip "X-Grip" red
Tubolare "X-Grip" rosso



art. 18259
Handgrip "X-Grip" green
Tubolare "X-Grip" verde



art. 18260
Handgrip "X-Grip" lilac
Tubolare "X-Grip" lilla

Carom Light



SMOOTH LATEX GRIP

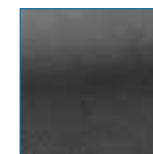

Thickness/spessore: 1 mm
Diam. 20/33 mm
Sold by meter/venduto al mt.

smooth surface
superficie morbida



art. 18163
Handgrip "Carom light"
Tubolare "Carom Light"

Contact

Material/materiale: silicone / silicone
Length/lunghezza: 29 cm
Weight /peso: \cong 18 gr



art. 18190
Handgrip "Contact"
Tubolare "Contact"

RUBBER
HANDGRIP

Material/materiale: rubber/gomma
Length/lunghezza: 29 cm
Weight /peso: \cong 26 gr



art. 1805907
Handgrip "Rubber" blue / Tubolare "Rubber" blu



art. 1805909
Handgrip "Rubber" black / Tubolare "Rubber" nero



art. 1805904
Handgrip "Rubber" red / Tubolare "Rubber" rosso



art. 1805910
Handgrip "Rubber" white / Tubolare "Rubber" bianco

Milano

Material/Materiale: silicone/silicone
Length/Lunghezza: 32,5 cm
Weight/Peso: \cong 13 gr



art. 18255
Handgrip "Milano" lilac / Tubolare "Milano" lilla



art. 18197
Handgrip "Milano" light blue / Tubolare "Milano" azzurro

Velvet Mg

Material/Materiale: rubber/gomma
Length/Lunghezza: 32 cm
Weight/Peso: \cong 15 gr



smooth and perforated surface
superficie traforata e vellutata

art. 3483
Handgrip "Velvet Mg" black
Tubolare "Velvet Mg" nero



Tubolari per stecche
OPERA

Material/Materiale: rubber/gomma
Length/Lunghezza: 30 cm
Weight/Peso: \cong 23 gr
Thickness/Spessore: 1,2 mm



art. 3562
Handgrip "Opera" white / Tubolare "Opera" bianco



art. 3563
Handgrip "Opera" blue / Tubolare "Opera" blu



art. 3564
Handgrip "Opera" black / Tubolare "Opera" nero



art. 3565
Handgrip "Opera" green / Tubolare "Opera" verde

KIMCHI
BILLIARDS

by
FC
Frédéric Caudron



HANDGRIPS KC CAUDRON 2020 / TUBOLARE KC CAUDRON 2020

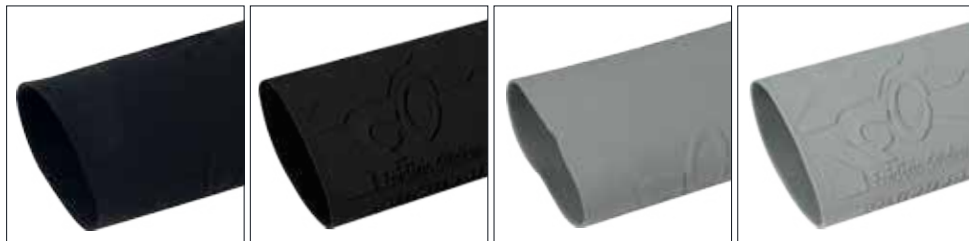

ART. 18288
BLACK
NERO

ART. 18286
BLACK TIRE PATTERN
NERO ZIGRINATO

ART. 18289
GRAY
GRIGIO

ART. 18287
GRAY TIRE PATTERN
GRIGIO ZIGRINATO

WEIGHT: 11/13 GR - LENGHT: 28 CM - MATERIAL: NATURAL RUBBER
PESO: 11/13 GR - LUNGHEZZA: 28 CM - MATERIALE: GOMMA NATURALE

Toscana
The handgrip for Carom
Per stecche da carambola

Length/Lunghezza: 32 cm
Weight/Peso: \cong 15 gr



CERTILOGO
VERA PELLE
MADE IN ITALY

Natural
Naturale

ART. 18175

Dark brown
Moro

ART. 18174

Black
Nero

ART. 18170

LONGONI
Made in Italy

BLACK FIRE 2.0

THE GLOVE

Sultan 2.0

THE GLOVE



CERTILOGO



CERTILOGO

BLACK FIRE 2.0 SULTAN 2.0,

the evolution of the already famous Longoni Black Fire and Sultan glove.

TECHNOFIBER

MICROFIBRA

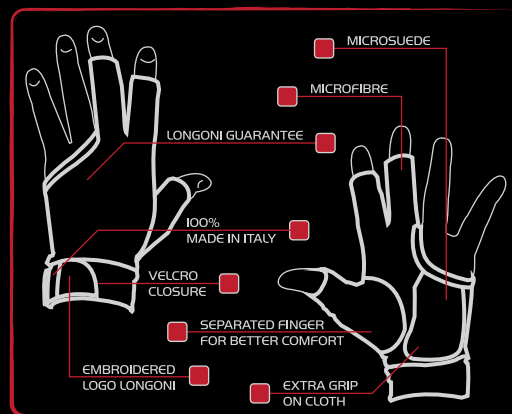

BLACK FIRE 2.0

SIZE TAGLIA	GLOVE FOR LEFT HAND GUANTO PER MANO SINISTRA	GLOVE FOR RIGHT HAND GUANTO PER MANO DESTRA
Small	12156	12156D
Medium	12157	12157D
Large	12158	12158D
XLarge	12159	12159D

New and innovative "Techno Fiber" fabric, breathable, comfortable and soft to the touch, machine washable (max 30°).

Sizes available: S - M - L - XL

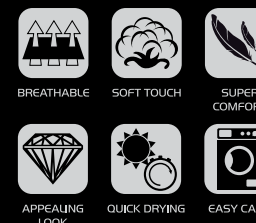

SULTAN 2.0

SIZE TAGLIA	GLOVE FOR LEFT HAND GUANTO PER MANO SINISTRA	GLOVE FOR RIGHT HAND GUANTO PER MANO DESTRA
Small	12160	12160D
Medium	12161	12161D
Large	12162	12162D
XLarge	12163	12163D



DESIGNED &
PRODUCED IN ITALY

CHART GUIDE SIZE GLOVES BLACK FIRE 2.0 E SULTAN 2.0

SIZE	S	M	L	XL
WIDTH IN CENTIMETERS (cm)	from cm 19 to cm 20,25	from cm 20,25 to cm 22,75	from cm 22,75 to cm 25,4	from cm 25,4 to cm 28
WIDTH IN INCHES (in)	from in 7,5 to in 8	from in 8 to in 9	from in 9 to in 10	from in 10 to in 11
LENGTH IN CENTIMETERS (cm)	from cm 18,2 to cm 18,8	from cm 18,8 to cm 19,4	from cm 19,4 to cm 20	from cm 20 to cm 20,6
LENGTH IN INCHES (in)	from in 7 1/8 to in 7 3/8	from in 7 3/8 to in 7 5/8	from in 7 5/8 to in 7 7/8	from in 7 7/8 to in 7 1/8

TABELLA TAGLIE GUANTI BLACK FIRE 2.0 E SULTAN 2.0

MISURA	S	M	L	XL
LARGHEZZA IN CENTIMETRI (cm)	da 19 cm a 20,25 cm	da 20,25 cm a 22,75 cm	da 22,75 cm a 25,4 cm	da 25,4 cm a 28 cm
LARGHEZZA IN POLLICI (in)	da in 7,5 a in 8	da in 8 a in 9	da in 9 a in 10	da in 10 a in 11
LUNGHEZZA IN CENTIMETRI (cm)	da 18,2 cm a 18,8 cm	da 18,8 cm a 19,4 cm	da 19,4 cm a 20 cm	da 20 cm a 20,6 cm
LUNGHEZZA IN POLLICI (in)	da in 7 1/8 a in 7 3/8	da in 7 3/8 a in 7 5/8	da in 7 5/8 a in 7 7/8	da in 7 7/8 a in 7 1/8

WIDTH / LARGHEZZA



LENGTH / LUNGHEZZA

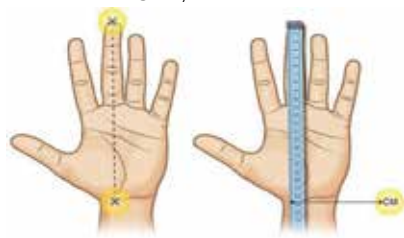

Fancy gloves, "Flags line"

Guanti fantasia, "linea bandiere"

MADE IN ITALY



SX	DX*
12150	12150D

SX
12147

SX
12148

SX	DX*
12149	12149D

* left-handed / per mancini

Except where specified, one size fits all. / Se non specificato diversamente si considera taglia unica.



Glove black, Renzline
Guanto nero, Renzline

SX	DX*
11078	11078D

MADE IN ITALY

Glove Torregiani - mixed colours
Guanto Torregiani - colori assortiti

SX	DX*
11111	11111D

MADE IN ITALY



Gloves multicolor, Renzline & Longoni - mixed colours
Guanti multicolor, Renzline & Longoni - colori assortiti

SX	DX*
11033	11033D

MADE IN ITALY



Glove Torregiani, openwork
Guanto Torregiani, traforato

SX	DX*
11165	11165D

MADE IN ITALY

Glove black, Longoni
Guanto nero, Longoni

SX	DX*
11078L	11078LD

MADE IN ITALY

* left-handed / per mancini

Except where specified, one size fits all. / Se non specificato diversamente si considera taglia unica.



Glove billard player, Renzline
Guanto giocatore biliardo, Renzline

size	SX						
color							
art	11089	11089A	11089C	11089G	11089RR	11089R	11089V

MADE IN ITALY



Glove bicoloured, Renzline - mixed colours
Guanto bicolore, Renzline - colori assortiti

SX
11013

MADE IN ITALY

Glove black, Renzline
Guanto nero, Renzline

SX
11019

MADE IN ITALY



Glove bocchette Renzline - mixed colours
Guanto bocchette Renzline - colori assortiti

SX	DX*
12005	12005D

MADE IN ITALY



Glove Renzline Start, black
Guanto Renzline Start, nero

SX
12122



Glove Renzline Start, blue
Guanto Renzline Start, blu

SX
12123



Glove Renzline Start, burgundy
Guanto Renzline Start, bordeaux

SX
12124



Glove Vaula
Guanto Vaula

	SX	DX*
S	18290	18290D
M	18291	18291D
L	18292	18292D
XL	18293	18293D

Glove Predator "Second skin"
Guanto Predator "Second skin"



	yellow/black		black/grey		yellow / giallo		red / rosso		blue / blu	
size	S/M	L/XL	S/M	L/XL	S/M	L/XL	S/M	L/XL	S/M	L/XL
art.	12202	12201	12204	12203	12205	12206	12207	12208	12209	12210

* left-handed / per mancini

Except where specified, one size fits all. / Se non specificato diversamente si considera taglia unica.

* left-handed / per mancini

Except where specified, one size fits all. / Se non specificato diversamente si considera taglia unica.

GLOVES / GUANTI

Glove KC by Caudron - Strap SX
 Guanto KC by Caudron - Strap SX

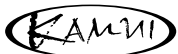

Black/red
 Nero/rosso

SX
18281



Black/navy
 Nero/navy

SX
18282



Black/blue
 Nero/blu

SX
18284



Black
 Nero

SX
18283



Glove Kamui "Quick dry" - black
 Guanto Kamui "Quick dry" - nero

	SX
S	16258
M	16259
L	16260



Glove Kamui "Quick dry" - blue
 Guanto Kamui "Quick dry" - blu

	SX
S	16261
M	16262
L	16263



Glove Kamui "Quick dry" - red
 Guanto Kamui "Quick dry" - rosso

	SX
S	16264
M	16265
L	16266

JOINT PROTECTORS / COPRIGIUNTI



Longoni "Nero" **VP2** joint protectors
 Coprigiunti Longoni "Nero" **VP2**

MODEL	SIZE MISURE	BUTT CALCIO	SHAFT PUNTA
5 BIRILLI	20 mm	3365	3369
CAROM	22 mm	3367	3386
POOL	21,3 mm	3366	3370
SR	18,8 mm	3364	3368



Longoni "Nero" **WJ22/BJ22** joint protectors
 Coprigiunti Longoni "Nero" **WJ22/BJ22**

BUTT / CALCIO	SHAFT / PUNTA
3290	3289



Longoni "Nero" **XP** joint protectors
 Coprigiunti Longoni "Nero" **XP**

BUTT / CALCIO	SHAFT / PUNTA
3292	3291



Longoni "Ulivo" **VPS** joint protectors
 Coprigiunti Longoni "Ulivo" **VP2**

BUTT / CALCIO	SHAFT / PUNTA
3516	3517



Longoni "Ulivo" **WJ22/BJ22** joint protectors
 Coprigiunti Longoni "Ulivo" **WJ22/BJ22**

BUTT / CALCIO	SHAFT / PUNTA
3434	3435



Longoni "Palissandro" **WJ22/BJ22** joint protectors
 Coprigiunti Longoni "Palissandro" **WJ22/BJ22**

BUTT / CALCIO	SHAFT / PUNTA
3495	3496

JOINT PROTECTORS / COPRIGIUNTI



Joss/Falcon joint protectors
Coprighiunti per Joss/Falcon

POOL 5/16-14
SET
3362



Meucci joint protectors
Coprighiunti per Meucci

POOL 5/16-18
SET
3361



POISON BULLET JOINT PROTECTOR

SET

3443



PREDATOR UNILOC

SET

3299



POISON GHOST JOINT PROTECTOR

SET

3444



JOINT PROTECTOR VP2 KIMCHI - set

6278 - Gold



JOINT PROTECTOR VP2 KIMCHI - set

6286 - Silver



JOINT PROTECTOR VP2 KIMCHI - set

6623 - Rainbow

RUBBER BUMPERS / PARACOLPI



art. 14020
Push'on rubber bumper, short
Paracolpo a pressione corto



art. 14264
Rubber bumper for cues
"Vecchio Mogano"
Paracolpo in gomma per steche
"Vecchio Mogano"



art. 14186
Sphere rubber bumper without
canvas
Paracolpo da incollare senza tela



art. 14025
Mushroom rubber bumper
Paracolpo a funghetto senza foro



art. 14021
Push'on rubber bumper, long
Paracolpo a pressione lungo



art. 14022
Bumper snap-tite, black rubber
Paracolpo a scatto



art. 14193
Mushroom rubber bumper with hole
Paracolpo a funghetto con foro



art. 14023
Rubber bumper for cues "Fibertech"
Paracolpo Longoni per "Fibertech"



art. 14709
Rubber bumper for cues "Cps"
Paracolpo in gomma per steche "Cps"



art. 14024
Sphere rubber bumper with canvas
Paracolpo da incollare con tela



art. 14450
Rubber bumper with Longoni logo
Paracolpo a funghetto con logo
Longoni



art. 14605
Rubber bumper for butt-end "Ogiva"
Paracolpo per calciolo ad "Ogiva"

RUBBER BUMPERS / PARACOLPI



art. 14699
D 28 mm - d 15,5 mm - h 18,6 mm
Rubber bumper for Predator Bk3,
break e sport
Paracolpo per stecca Predator Bk3,
break e sport



art. 14618
D 27 mm - d 15 mm - h 17 mm
Rubber bumper cue Predator P3
Paracolpo stecca Predator P3

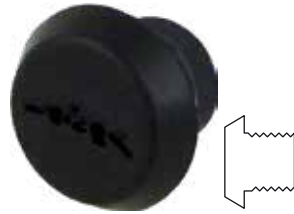

art. 14956
D 25 mm - d 16 mm - h 18 mm
Rubber bumper cue Sneaky Pate
Paracolpo stecca Sneaky Pate



art. 24801
D 24,5 mm - d 15,7 mm - h 24,2 mm
Bumper for predator QR II extension
paracolpo per prolunga predator QR II

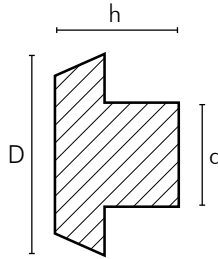

LONGONI BUTT-END CUPS / CALCIOLI LONGONI



art. 14540
Butt-end "Ogiva", black
Calciolo "Ogiva", nero



art. 14541
Aluminium butt-end "Ogiva"
Calciolo "Ogiva" alluminio



art. 25784
Aluminium butt-end "Vibraless"
Calciolo "Vibraless" alluminio

LOBITE

SCREWLESS EXTENSION JOINT

AS SEEN ON
YouTube
LONGONICUES

NO THREAD

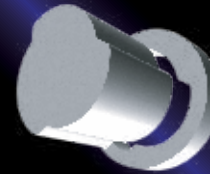

LOBITE is the first joint that doesn't need a thread to close. The innovative section with three lobes innovates the way of constructing a joint. A step ahead in the future.

2 FAST 4 YOU

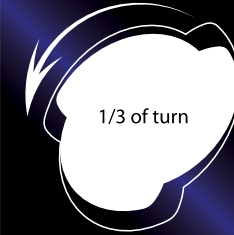

LOBITE has a brand new shape. With one third of turn you can easily close tightly the joint. No vibrations or loose feelings

EASY TO INSTALL



LOBITE has been developed to be easily installed by any skilled technician on any Longoni carom butt (minimum end diameter of 32 mm is required)

STYLE BEHIND TECHNIC

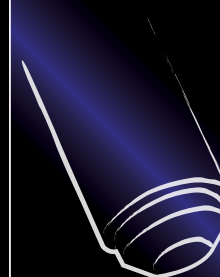

The rubber bumper has been developed to match with any cue design. Avoid any kind of vibration and it's easy to replace in a few seconds.

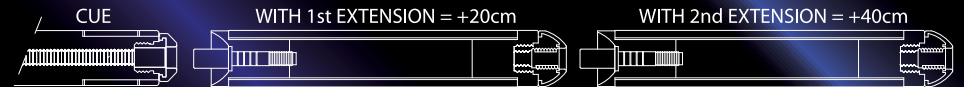

The **LOBITE** system, thanks to its modularity, gives you the possibility of installing more than one extension. At the end of each extension **LOBITE** you'll have the joint to connect a new one. Stability and resistance are guaranteed. A maximum of 3 extensions is suggested.

CUE WEIGHT AND LOBITE

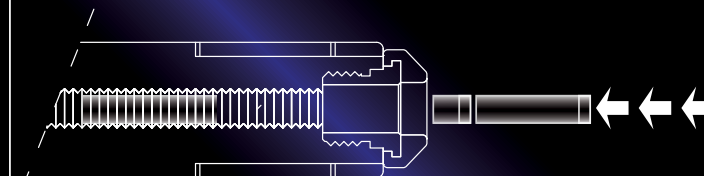

LOBITE guarantees you the possibility of adding or removing original Longoni new system of weights (art 14419).



3LOBITE
SCREWLESS EXTENSION JOINT

LONGONI



art. 14532
Set of tools for 3lobite installation
Kit attrezzi per installazione 3lobite



art. 23161
Rubber bumper "3lobite", 3gr
Paracolpo gomma "3lobite", 3gr



art. 23184
Rubber bumper "3lobite" slim, 3gr
Paracolpo gomma "3lobite" slim, 3gr



art. 23183
3lobite aluminium slim component for extension (rubber bumper included), 10 gr
Supporto alluminio 3lobite slim per prolunga compreso di gomma, 10 gr



art. 23232
3lobite brass slim component for extension (rubber bumper included), 24 gr
Supporto ottone 3lobite slim per prolunga compreso di gomma, 24 gr



art. 23220
Pin 3lobite brass, 32 gr
Perno 3lobite ottone, 32 gr

XTENDO

Original parts
Made in Italy

3LOBITE
SCREWLESS EXTENSION JOINT

The new Longoni extension for 3lobite system



CERTILOGO



EXTENSION LONGONI XTENDO 3K CARBON PROLUNGA LONGONI XTENDO 3K CARBONIO				
3LOBITE TWO INCHES - 50mm	3LOBITE 10cm	3LOBITE 20cm	3LOBITE 30cm	3LOBITE COMBO 20+10cm
24622	24586	24587	24588	24589



5QUILLES EXTENSION - PROLUNGA 5 BIRILLI

Name / Nome	Item Articolo	Wheigh Peso	Lenght Lunghezza	Diameter Diametro	Joint Giunto	Rubber bumper Paracolpo	Handgrip Tubolare
Zenith "Gold M short"	24126	150 gr	20 cm	32 mm	Gold	Classic/Classico	Neoprene



5QUILLES EXTENSION - PROLUNGA 5 BIRILLI

Name / Nome	Item Articolo	Wheigh Peso	Lenght Lunghezza	Diameter Diametro	Joint Giunto	Rubber bumper Paracolpo	Handgrip Tubolare
Zenith "Gold F"	24088	220 gr	40 cm	32 mm	Female Gold	Classic/Classico	Neoprene



5QUILLES EXTENSION - PROLUNGA 5 BIRILLI

Name / Nome	Item Articolo	Wheigh Peso	Lenght Lunghezza	Diameter Diametro	Joint Giunto	Rubber bumper Paracolpo	Handgrip Tubolare
Zenith "Att Rapido"	24081	255 gr	40 cm	32 mm	Att rapido	Classic/Classico	Neoprene

art. 4589

Black universal telescopic extension
Prolunga telescopica nera universale



**SUITABLE FOR
CAROM BUTTS
FROM DIAM.
30mm TO 32 mm**

**ADATTA PER
CALCI CON
DIAMETRI DA
30 mm A 32 mm**



art. 14814

Extention Predator QR II 12IN (30,5cm)
Prolunga Predator QR II 12IN (30,5cm)

art. 24800

Extention Predator QR II (20cm - 8in)
Prolunga Predator QR II (20cm - 8in)

art. 14811

Extention Predator QR II - Mini (7cm - 3in)
Prolunga Predator QR II - Mini (7cm - 3in)

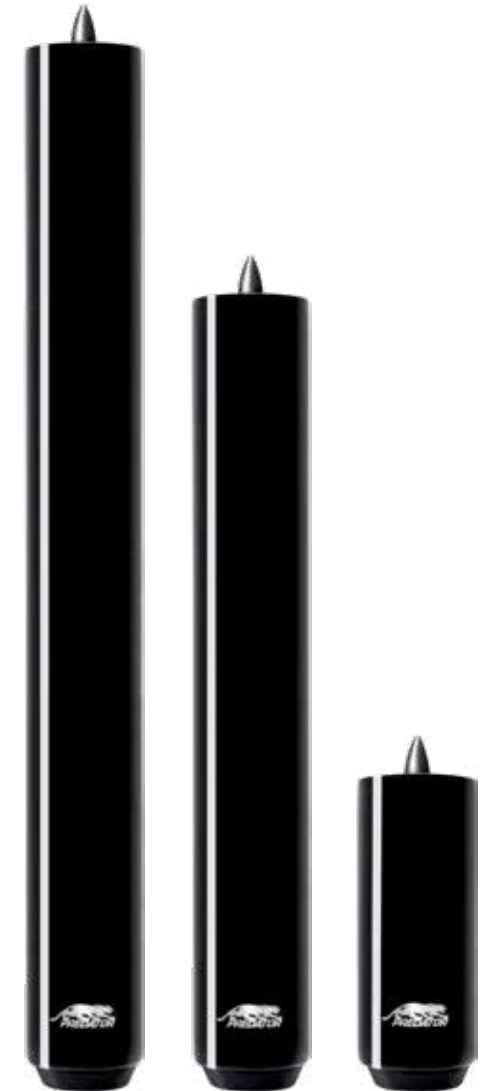

The QR2 and QR2 Mini Extension from Predator pair with any Predator cue equipped with the Uni - Loc Weight Cartridge System. They allow to lengthen the cue of 30,5 cm (QR2 12IN), 20 cm (QR2) or 7 cm (QR2 Mini). The quick releasing extensions are easy to install, just remove the original bumper of the cue and install the Uni- Loc QR Extension2 bumper using a standard 6 mm allen wrench, twist on the QR Extension2 handle and you are ready to go.

To be used only separately, not in addition to any other extension.

Le prolunghe by Predator sono compatibili con tutte le stecche Predator dotate del sistema Uni-Loc® Weight Cartridge. Permettono di allungare la stecca di 30,5 (QR2 12IN), 20 cm (QR2) o 7 cm (QR2 MINI). Si installano facilmente rimuovendo il paracolpo originale della stecca e installando il paracolpo Uni-Loc® QR Extension con l'aiuto della brugola da 6mm (non in dotazione). Le prolunghe si avvitano poi facilmente alla stecca con un colpo di mano.

Utilizzabili solo separatamente, non in aggiunta ad altra prolunga.

WEIGHT SYSTEM FOR LONGONI CUES / SISTEMA PESI PER STECCHE LONGONI

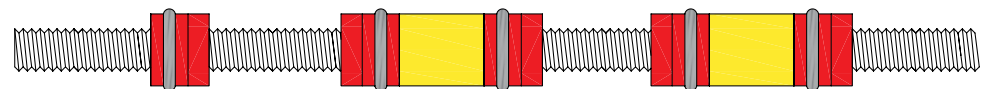

Complete rod / Astina completa

BRASS WEIGHTS/PESI OTTONE						WEIGHT STOPPERS FERMAPESI	O-r (rubber/gomma)
Ø	gr 1	gr 5	gr 10	gr 20	gr 30	art	art
10 mm	14443	14444	14293	14294	14337	14454	1023
8 mm	14451	14452	14442	14441	14453	14455	1023
6 mm	-	14529	14530	-	-	14528	1023



Art. 14049
Weight set 20 gr Ø 31 mm (Set 3 pcs)
Peso 20 gr. Ø 31 mm (Set 3 pezzi)



Art. 14050
Weight set 15 gr Ø 26 mm (Set 3 pcs)
Peso 15 gr. Ø 26 mm (Set 3 pezzi)



BRASS WEIGHTS/PESI OTTONE					WEIGHT STOPPERS FERMAPESI	KIT COMPLETO	
Ø	gr 10	gr 20	gr 30	gr 30	gr 40	art	art
C/K/G e composita	14390	14391	14392	24676	24676	14470	24699



Art. 14419
Weight screws Longoni set
Kit pesi a vite Longoni
1X5 gr, 1x10 gr, 1x20 gr, 1x30 gr





Art. 14616
Weight kit for Predator P3 cue
Kit pesi stecca Predator P3



Art. 14691
Weight for Poison cues - Mixed
Pesi a vite per stecche Poison - Misti



art. 17223
Bridge head black
Stella bridge nera



art. 17040
Bridge head plastic
Stella bridge plastica nera



art. 18403
Bridge head Lux, black
Stella bridge nera Lux



art. 17194
Bridge head brass (short)
Stella bridge ottone (corta)



art. 17192
"U" bridge head brass (medium)
Stella bridge ottone (media)



art. 16274
Head bridge Kamui "Vue"
Stella bridge Kamui



art. 1033
Longoni bridge head brass (long)
Stella bridge ottone (lunga)



art. 1034T
Brass hook standard for cuerest
Gancio ottone standard appoggiastecca



art. 1038
Cross brass, snooker
Crocetta ottone per snooker



art. 1036
Bumper screw for brass bridge
Gommini per ganci e bridge

SUMMA

The definitive tool Made in Italy



THE PERFECT TOOL FOR POOL, CAROM, "5 BIRILLI" AND PYRAMID PLAYERS

"A" - Diamonds shaped surface: help to create micro holes that hold the chalk in depth. Highly improves playability of the cue and cue ball control.

"B" - Abrasive top shaper: create the perfect top shape of the tip to improve contact with the cue ball. This part is easily replaceable.

"C" - Tip side trimmer: working on the side, it helps in removing the leather that hit after hit went out of the ferrule. This part is easily replaceable.

"D" - Conic compressor: after removing the "mushroom tip" this part compress the leather making it shine and durable in time.

Summa is totally "made in Italy" with a solid aluminium structure and easily replaceable parts.

L'ATTREZZO PERFETTO PER I GIOCATORI DI "5 BIRILLI", CARAMBOLA, POOL E PIRAMIDE RUSSA

"A" - Lima a piramidi: grazie alla particolare forma, questa superficie permette di creare piccoli fori nel cuoio per far penetrare meglio il gesso in profondità, aumentando il contatto e migliorando gli effetti nel gioco.

"B" - Sagomatore frontale: grazie alla sua particolare curva permette di sagomare perfettamente il cuoio. La parte abrasiva è facilmente sostituibile con appositi ricambi.

"C" - Sagomatore laterale (su due lati): permette di rimuovere facilmente il cuoio "spanciato" sui lati. La parte abrasiva è facilmente sostituibile con appositi ricambi.

"D" - Compressore conico: dopo aver rimosso il cuoio in eccesso sui lati, grazie a questa funzione è possibile comprimere la pelle rendendola compatta e lucida. Aumenta notevolmente la vita del cuoio.

Summa è totalmente "made in Italy". La sua struttura in alluminio è solida e la parti facilmente sostituibili.

Art. 16209
Suitable for 11,6 to 13,5 mm
diameter shafts.
Adatto a puntali con
diametro da 11,6 a 13,5 mm.

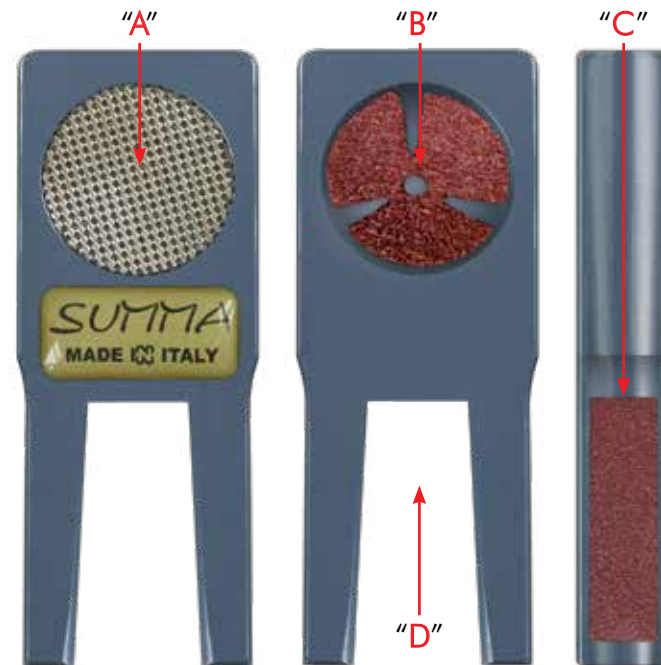

Art. 16216
Suitable for 9 to 11,5 mm
diameter shafts.
Adatto a puntali con
diametro da 9 a 11,5 mm.



Art. 16210
Smooth paper for Summa
(3 complete sets)
Abrasivi per Summa
(3 ricambi completi)



art. 16230
Tip shaper Renzline "Clessidra" - aluminium
Raschietto Renzline "Clessidra" - alluminio

art. 16400
Tip shaper Renzline "The Helmet"
Raschietto Renzline "The Helmet"



art. 16231
Scuffer "Steel Shaper"
Raschietto "Steel Shaper"



art. 16232
Scuffer "Dragon Shaper"
Raschietto "Dragon Shaper"



art. 3397
Tip shaper "Diamond"
Raschetto "Diamond"



art. 16219
Tip trimmer gator grip brown
Raschietto gator grip marrone



art. 16218
Tip trimmer gator grip black
Raschietto gator grip nero



art. 16238
Tip shaper "Bohemia"
*colours can change without any previous notice
Raschetto "Bohemia"
*variazioni di colori possibili

THE PATENT DEVICE FOR THE FLATTENING OF FERRULES AND CUE TIPS
 IL DISPOSITIVO BREVETTATO PER LA SPIANATURA DI GHIERE E CUOI



Remove the device for the flattening ferrule and insert in the pin the proper disk, put into position the cue tip (or more cue tips) to be levelled in the hole which corresponds to the diameter. Rotate the device with the abrasive keeping it pushed towards the disk containing the cue tip to be flattened.

Togliere il dispositivo per la spianatura della ghiera ed inserire nel perno l'apposito dischetto posizionando il cuoio (o i cuoi) da spianare, nell'incavo corrispondente al diametro stesso. Ruotare il piattello con l'abrasivo tenendolo premuto contro il dischetto contenente il cuoio da spianare.



Insert the shaft in the proper pass and block it rotating softly the knob. Rotate pushing softly towards down making adhere the abrasive part to the ferrule.

Inserire il puntale nell'apposito canaletto e bloccare ruotando leggermente la manopola. Ruotare delicatamente premendo verso il basso facendo aderire la parte abrasiva alla ghiera



art. 11074
 Replacement abrasive disk
 Dischetto abrasivo per jolly cue



WWW.JOLLYCUE.COM



art. 11034
 "Top Sander" tool
 Macchinetta raschia ghiera "Top Sander"



art. 16065
 American scuffer
 Raschietto americano



art. 16276
 Shaver "mushroom graser"
 Raschietto "mushroom graser"



art. 16222
 Scuffer hexagonal
 Raschietto esagonale



art. 14587
 Combo top trimmer Ø 13 mm
 Raschietto Combo Ø 13 mm



art. 14409
 Scuffer - mixed colours
 Raschietto - colori assortiti



art. 16009
 Plastic scuffer
 Raschietto per cuoi in plastica



art. 16076
 Scuffer for cue tips red
 Raschietto per cuoi rosso



art. 16061
 Scuffer porcupine for tips
 Raschietto porcospino per cuoi



art. 16027
 Squared scuffer
 Raschietto per cuoi quadrato



art. 16120
 Scuffer tip pic
 Raschietto porcospino ottone

ABRADO

Art. 16239

The micro-abrasive set for cleaning wood shafts.
Il set di carta micro-abrasiva per la pulizia delle punte in legno.



ABRADO: DIRTY OUT, WOOD SAFE!

This set has been developed to smoothly sand dirty off your wooden shafts without damaging them.

The plastic material used to hold the abrasive allows you to re-wash sheets and re-use them several times (dry them before sliding them back into the cover).
USAGE: slightly sand your shaft starting with the green paper first, then yellow and blue as last. Use Longoni cue wax for a pro final touch

ABRADO: RIMUOVI LO SPORCO E PROTEGGI IL LEGNO!

Questo set è stato studiato per ripulire le punte in legno senza danneggiarle. Il materiale plastico usato per mantenere salda la parte abrasiva consente di lavare il foglio per poterlo utilizzare più volte (far asciugare prima di riporlo nuovamente nell'apposita confezione dopo l'utilizzo)

USO: carteggiare leggermente la punta iniziando con il foglio verde e utilizzando poi il giallo e il blu da ultimo. Utilizzare la cera Longoni al termine dell'operazione per rendere la superficie liscia al tatto.

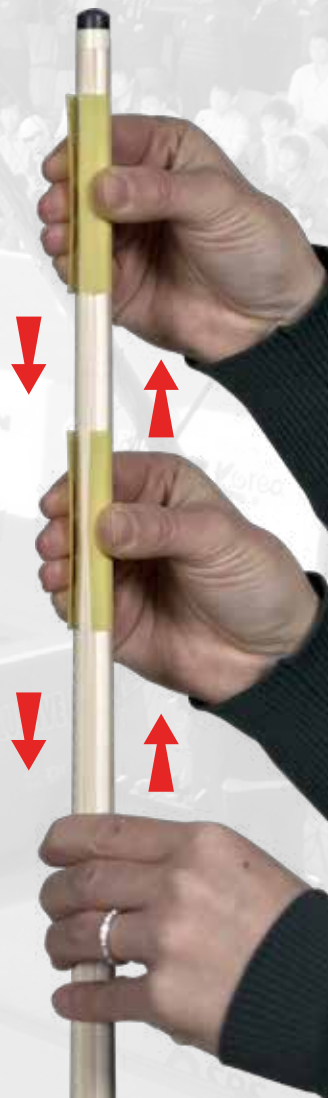

LONGONI
LONGONICUES.COM

CERTILOGO

MADE IN ITALY FOR YOUR GAME



art. 10460
Tip shaver Q-shaver
Raschia cuoi Q-shaver



art. 14263
Wooden cue clamp
Pressacuoio legno



art. 14111
Cue clamp red plastic
Pressacuoio rosso, plastica



art. 16217
Cutter "Cut rite"
Tagliacuoio "Cut rite"



art. 16221
Cutter cut rite - replacing blade
Lama di ricambio per "Cut rite"



art. 16401
Metal steel cue clamp tool for tips Ø 14 mm
Spremicuoio in metallo cromato per cuoi Ø 14 mm



art. 16119
Tip trimmer
Temperino per punte stecche



art. 16025
Cue shaft slicker
Tubolare per levigare punta stecca



art. 11045N
Longoni towel
Salviettina in spugna Longoni



art. 11157
Predator towel
Salviettina in spugna Predator



art. 28083
Revo shaft cleaning towel
Salviettina pulisci punta Revo



art. 17583
Protective cream for wooden shafts.
Crema longoni protettiva per punte in legno.



Art. 14633
Tip protector Ø 12-12,5 mm
Proteggi cuoio Ø 12-12,5 mm

Art. 14629
Tip protector Ø 12,5-13 mm
Proteggi cuoio Ø 12,5-13 mm

*colours can change without any previous notice
*variazioni di colori possibili



art. 3033
Cue repair Kit
Scatoletta per riparazione stecche



art. 3036
Glue "ten minutes cement" gr.30
Mastice 10 minuti gr. 30

No Blue! *The amazing sponge* *The amazing polish*

The best products to clean your shaft instantly without damage!
Il migliori prodotti per pulire la tua punta all'istante senza danni!

Abrasive polish with neutral ph, solvents free. Effective, quick, easy, practical, safe.

Lucidante abrasivo a ph neutro senza solventi.
Efficace, rapido, semplice, pratico, sicuro.

LONGONI
Original parts



art. 18274
Abrasive cream Longoni No Blue
Crema abrasiva Longoni No Blue

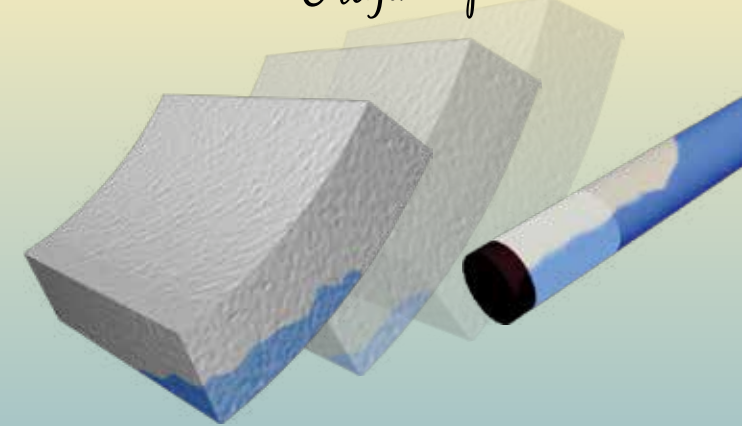

RENEW YOUR OLD WOODEN SHAFT!

- No shaft diameter modification
- Deeply remove any chalk left
- A new smooth feeling on your shafts
- Save a lot of money extending the life of your shaft
- Pocket packed, easy to carry in the bag
- No chemical products needed
- Ultra light sandpaper included in the package

RINNOVA IL TUO PUNTALE IN LEGNO!

- Nessuna modifica del diametro
- Rimuove tutto il gesso rimasto nei pori
- Rinnova il tuo puntale con un gesto
- Allunga la vita della punta risparmiando
- Facile da trasportare: non sporca il tuo fodero
- Non servono altri prodotti chimici
- Carta abrasiva per levigare inclusa nella confezione



art. 17809
Sponge No Blue 1 pcs.
Spugna No Blue 1 pz.

art. 17809-10
Sponge No Blue set of 10 pcs.
Spugna No Blue set di 10 pz.

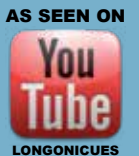

977 PRO GLUE

Art. 3358

LONGONI



5g  3min

THE PROFESSIONAL GLUE FOR YOUR CUE.
IT DOESN'T CRYSTALLIZE AND VITRIFY.
SUITABLE FOR ALL TIPS AND MOST FERRULES.

LA COLLA PROFESSIONALE PER
LA VOSTRA STECCA.
NON CRISTALLIZZA E NON VETRIFICA.
ADATTA PER TUTTI I CUOI E LE GHIERE
APPLICATE SU PUNTE IN LEGNO.

CYANOCRYLATE. DANGER!
IRRITATING TO EYES, RESPIRATORY SYSTEM AND SKIN. IT STICKS SKIN AND EYES IN A FEW SECONDS. KEEP OUT OF REACH OF CHILDREN.
DO NOT BREATHE GAS/FUMES/AEROSOL. AVOID CONTACT WITH EYES AND SKIN. IN CASE OF CONTACT WITH EYES RINSE IMMEDIATELY WITH PLENTY OF WATER AND SEEK MEDICAL ADVICE. USE ONLY IN WELL-VENTILATED AREAS.

CIANOCRILATO. PERICOLO!
IRRITANTE PER GLI OCCHI, LE VIE RESPIRATORIE E LA PELLE. SI INCOLLA ALLA PELLE E AGLI OCCHI IN POCHI SECONDI. TENERE FUORI DALLA PORTATA DEI BAMBINI.
NON INALARE VAPORE/AEROSOL. EVITARE IL CONTATTO CON GLI OCCHI E CON LA PELLE. IN CASO DI CONTATTO CON GLI OCCHI, LAVARE IMMEDIATAMENTE E ABBONDANTEMENTE CON ACQUA E CONSULTARE IL MEDICO. USARE SOLTANTO IN LUOGO BEN VENTILATO.

THE NEW SPECIAL CLOTH BY
L'ONGONI FOR THE CUE MAINTENANCE.

RED TOUCH
ULTRA SOFT
MICROFIBER



art. 4585
Cloth Longoni Red Touch ultra soft microfiber - 1 pcs.
Panno Longoni Red Touch ultra soft microfiber - 1 pz.

art. 4585-15
Cloth Longoni Red Touch ultra soft microfiber - box 15 pcs.
Panno Longoni Red Touch ultra soft microfiber - box 15 pz.

NIR BILLIARD TALC



NIR BILLIARD TALC
Talc for billiard contained in a practical package trip.
Useful to absorb the sweat and slide better your shaft on your hand

TALCO PER BILIARDO
Talc per biliardo in una pratica confezione da viaggio.
Utile ad assorbire il sudore e a far scorrere meglio in puntale sulla vostra mano.

art. 3378-24
NIR BILLIARD TALC - BOX 24 PCS
TALCO PER BILIARDO NIR - BOX 24 PZ

art. 3378
NIR BILLIARD TALC - 1 PC
TALCO PER BILIARDO NIR - 1 PZ

SPECIAL WAX FOR WOODEN SHAFTS*

SUITABLE FOR ALL WOODEN SHAFTS



**NEW
FORMULA**
MADE IN ITALY

SPECIAL WAX FOR WOODEN SHAFTS - SUITABLE FOR ALL WOODEN SHAFTS

The Longoni special wax is a natural based product especially developed for wooden shafts. Thanks to the innovative formula this wax will make your shaft smoother to touch, with a silky sensation. Your game will be considerably improved and your shaft will last longer.

CERA SPECIALE PER PUNTALI IN LEGNO - ADATTA PER TUTTI I PUNTALI IN LEGNO

La cera speciale Longoni è un prodotto naturale creato appositamente per puntali in legno. Grazie alla sua formula innovativa questa cera rende la punta piu' liscia al tatto regalando una sensazione vellutata. Il gioco migliorerà notevolmente e la punta durerà piu' a lungo.



Art. 3478-36
36 pcs./pz.



Art. 3478
1 pc./pz.

AS SEEN ON



LONGONICUES

Blue DIAMOND

BILLIARD CHALK

WORLD
CHALK



LONGONI

BLUE DIAMOND CHALK

The best and most required billiard chalk worldwide. This outstanding product has been developed by LONGONI years ago to satisfy the demand of the world elite of billiard and pool players, searching for the "perfect" chalk. In order to guarantee a high level of quality this particular chalk is produced in very limited quantities only. This creamy chalk sticks extremely long at the tip, shot after shot. The best tip on the market is worth nothing without the control that chalk is able to offer.

GESO BLUE DIAMOND

Semplicemente il miglior gesso al mondo. Questo straordinario prodotto è stato sviluppato da Longoni molti anni fa per soddisfare la richiesta di giocatori d'élite alla ricerca di un gesso migliore. Per garantire un alto livello di qualità, il gesso è prodotto in quantità limitate. Questo gesso cremoso si mantiene a lungo sul cuoio colpo dopo colpo. Il miglior cuoio al mondo non vale nulla senza il controllo che un buon gesso può offrire.



art. 7068
Blue Diamond Chalk, box 2 pcs.
Gesso Blue Diamond, scatola 2 pz.

art. 7068-25
Blue Diamond Chalk, 25 box 2 pcs.
Gesso Blue Diamond, 25 scatole 2 pz.

CERTILOGO



**NOW ALSO
GREEN!**

**ORA ANCHE
VERDE!**



art. 7179-25
Nir Super Professional blue chalk, 25 box 3 pcs.
Gesso Nir Super Pro blu, 25 box 3 pz.

Art. 7179
Nir Super Professional blue chalk, 3 pcs.
Gesso Nir Super Pro blu, 3 pz.

art. 7407-25
Nir Super Professional green chalk, 25 box 3 pcs.
Gesso Nir Super Pro verde, 25 box 3 pz.

Art. 7407
Nir Super Professional green chalk, 3 pcs.
Gesso Nir Super Pro verde, 3 pz.



NIR SUPER PROFESSIONAL CHALK

The NIR SUPER PROFESSIONAL chalk has been recently developed. This European quality product allows to the players to reach an high level of control with every shot. Many Pros have already discovered this excellent product and they are frequently using it in their game.

GESO NIR SUPER PROFESSIONAL

Il gesso NIR SUPER PROFESSIONAL è un gesso sviluppato recentemente. Questo prodotto di qualità europea permette ai giocatori di ottenere un alto livello di controllo ad ogni colpo. Molti professionisti hanno già scoperto questo eccellente prodotto e lo usano già frequentemente durante il loro gioco.

SILVER CUP - BOX 12 PCS						
burgundy bordeaux	gray grigio	copper rame	light green verde chiaro	olive green verde oliva	orange arancione	pewter peltro
7502	7503	7504	7506	7507	7508	7509
pink rosa	plum prugna	powder blue blu polvere	purple viola	royal blue blu royal	spruce verde abete	tan marrone chiaro
7510	7511	7512	7513	7514	7515	7516

white bianco	wine vino
7517	7518



Silver Cup chalk - box 12 pcs.
Gesso Silver Cup - 12 pz. per conf.

MASTER CHALK - BOX 12 PCS						
blue / blu	gray / grigio	brown/marrone	black / nero	gold / oro	red / rosso	green / verde
7005	7064	7007	7310	7253	7006	7008



Master chalk - box 12 pcs.
Gesso Master - 12 pz. per conf.



art. 14083
Chalk and chalk-holder personal master
Gesso con portagesso master



art. 7056
Master chalk blue - box 144 pcs.
Gesso Master blue - 144 pz. per conf.



art. 7057
Triangle chalk blue - box 144 pcs.
Gesso Triangle blu - 144 pz. per conf.



art. 6198
N.T. Chalk blue - box 12 pcs.
Gesso Tournament blue - 12 pz. per conf.



art. 7001
Triangle chalk blue - box 12 pcs.
Gesso Triangle blu - 12 pz. per conf.



Art. 7519
Chalk Predator - box 5 pcs
Gesso Predator - box 5 pz



art. 7003
Pioneer chalk blue - box 12 pcs
Gesso Pioneer blu - 12 pz. per conf.



art. 7292
Chalk Lava blue - box of 2 pcs
Gesso Lava blu, 2 cubetti

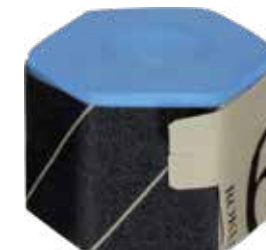

art. 16278
Chalk Kamui Roku - 1 pc
Gesso Kamui Roku - 1 pz

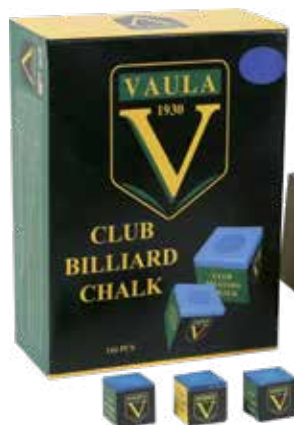

Chalk holder Vaula TN
Portagesso Vaula TN



art. 4622
Chalk Vaula blue - box 12 pcs
Gesso Vaula blu - 12 pz. per conf.



art. 4623
Chalk Vaula blue - box 144 pcs
Gesso Vaula blu - 144 pz. per conf.

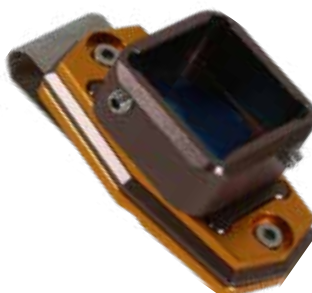

silver-light blue / argento-azzurro	yellow-brown / giallo-marrone	red-black / rosso-nero
4586	4587	4599



art. 16285
Chalk case Kamui for Roku chalk
(without magnetic support)
Portagesso Kamui magnetico per
gesso Roku (senza clip)

CHALK HOLDER / PORTAGESSO LIBELLULA

Art.14086



Pro easy clip to grip to the belt.
Clip per aggancio alla cintura.

Talc dispenser.
Distributore talco.

Sandpaper for a better grip of the
chalk on the cue tip.
Carta vetrata per aumentare il grip
del gesso al cuoio.

A BLUE DIAMOND CHALK INCLUDED in the price.
Vano con gesso professionale Longoni BLUE DIAMOND in OMAGGIO.



art. 14106
Magnetic chalk holder, imitation leather
Portagesso magnetico in pelle, simil-pelle



art. 3485
Chalk holder Steel RR
Portagesso Steel RR



Chalk holder Thai with screw
Portagesso Thai con vite



art. 4592
white / bianco

art. 4593
black / nero

art. 4594
burgundy / bordeaux

art. 4595
purple / viola

art. 4596
green / verde



MAGNETIC CHALK HOLDER DISEGNED FOR THE WORLD CHAMPION FREDERIC CAUDRON.

MADE OF DURALUMINIUM (ULTRA LIGHT) WITH PRECISE CNC TECHNOLOGY.

SUITABLE FOR ALL TYPE OF STANDARD CUBIC CHALKS.

CHALK NOT INCLUDED.

PORTAGESSO CON CHIUSURA MAGNETICA DISEGNATO PER IL CAMPIONE DEL MONDO FREDERIC CAUDRON.

REALIZZATO IN DURALLUMINIO (LEGA ULTRALEGGERA) CON MACCHINARI CNC.

ADATTO A TUTTI I GESSI DI FORMA CUBICA DI MISURA STANDARD.

GESSO NON INCLUSO.

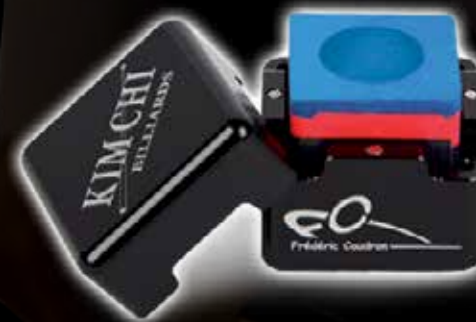

	SILVER	BLACK
ART.	14649	14653



art. 14080
Chalk holder De luxe NIR
Portagesso De luxe NIR



art. 14078
Chalk holder basic
Portagesso basic



art. 5407
Chalk holder leather Pouch
Portagesso Leather Pouch



art. 14702
Chalk holder Lemon RR
Portagesso Lemon RR



art. 14081
Chalk holder, vinyl
Portagesso in vinile



Magnetic chalk holders / Portagessi magnetici

red / rosso	blue / blu	grey / grigio	black / nero
14610	14609	14611	14104



art. 3030
Master talc Cone
Cono talco Master



art. 14100
Talc cone holder
Mensola portatalco



art. 14107
Talc bag
Sacchetto portatalco

Longoni official sportswear - Abbigliamento ufficiale Longoni



Polo Longoni white - 100% cotton
Polo Longoni bianca - 100% cotone

Size/ Taglia	S	M	L
Art.	11242	11243	11244



Polo Longoni black - 100% cotton
Polo Longoni nera - 100% cotone

Size/Taglia	S	M	L	XL	XXL
Art.	11239	11240	11241	11263	11266

Woman - slim fit
Donna - slim fit

Size/ Taglia	S
Art.	11264



Sweatshirt Longoni black - 100% cotton
Felpa Longoni nera - cotone 100%

Size/ Taglia	S	M	L
Art.	11245	11246	11247



Sweatshirt Longoni light blue with Italian flag profiles - cotton 100%
Felpa Longoni azzurra con profili tricolore - cotone 100%

Size/ Taglia	S	M	L	XL	XXL
Art.	11227	11208	11209	11210	11211



Polo Longoni blue with Italian flag profiles - 100% cotton
Polo longoni blu in piquet con profili tricolore su collo e polsini - cotone 100%

Size/ Taglia	M	L	XL
Art.	11202	11203	11204

Size/ Taglia	L (8-11YEARS)	XL (12-14 YEARS)
Art.	11236	11237



Art. 11260
Hat Longoni black with Italian flag
Cappellino Longoni nero con tricolore



Art. 24329
Patch Longoni
Cucisivo Longoni



Art. 11159
Golf shirt Predator - various sizes
Polo Predator - taglie miste (s,m,l,xl)

Tomasi
MADE IN ITALY



• **Billiard Comfort Shoe** •
MADE IN ITALY

Norditalia Ricambi s.r.l. has decided to expand the wide range of accessories with a special shoe totally made in Italy, perfect for the billiard game.

This product produced in Toscana exclusively for Norditalia Ricambi s.r.l. by the famous company F.lli Tomasi has been developed to guarantee hours of comfort during your training and competition activities.

Below, the strength points of "Billiard Comfort shoe":

- Ultralight weight: 340 gr per shoe.
- Use of non-toxic certified leathers, soles, insoles and adhesives.
- Replaceable and removable insole, also with adapted versions.
- Upper and lining completely in veal leather made in Santa Croce Sull'Arno- Pisa.
- Extra-light, anti-slip EVA sole.
- Large fitting and high volume for a better comfort and stability.
- Not embossed seams to avoid annoying rubbings.
- Soft black leather in compliance with the international regulations.

Norditalia Ricambi s.r.l. arricchisce la già vasta gamma di accessori con una speciale scarpa totalmente made in Italy indicata per il gioco del biliardo.

Questo modello prodotto in Toscana in esclusiva per Norditalia Ricambi s.r.l. dalla famosa ditta F.lli Tomasi, è stato sviluppato per garantire ore di comfort durante la vostra attività di allenamento e competizione.

Ecco i punti d'eccellenza della "Billiard Comfort shoe":

- *Peso ultralight: 340gr a scarpa.*
- *Utilizzo di pelli, soles, solette e collanti certificati atossici.*
- *Plantare removibile e sostituibile anche con versioni adattate.*
- *Tomaia e fodera interamente in pelle di vitello prodotte a Santa Croce sull'Arno - Pisa.*
- *Suola in EVA, extra light, antiscivolo.*
- *Calzata larga e volume alto per un maggior confort e stabilità.*
- *Cuciture non a rilievo per evitare fastidiosi sfregamenti.*
- *Morbida pelle di colore nero in conformità ai regolamenti internazionali.*

Size/ Taglia	39	40	41	42	43	44	45
Art.	17075-39	17075-40	17075	17075-42	17075-43	17075-44	17075-45



**Soccer Tables
Calcio Balilla**

STAD

The outdoor soccer table
Il calcetto da esterno

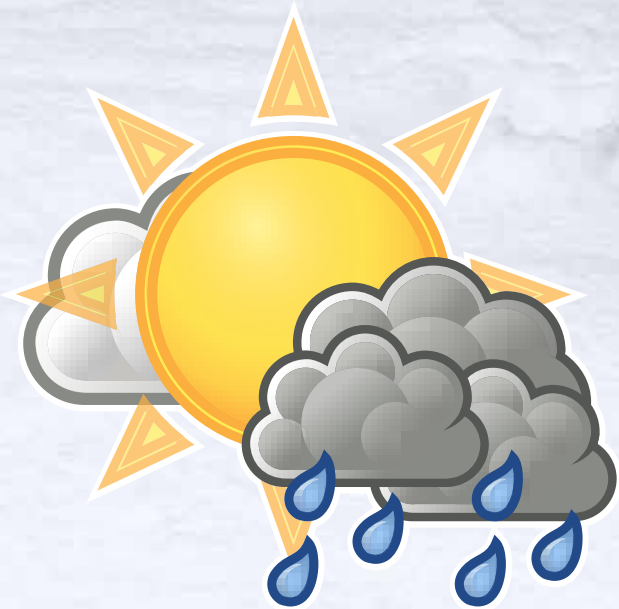

AS SEEN ON



NORDITALIARICAMBI

TROLLEY by **המרתה** Outdoor

MADE IN ITALY

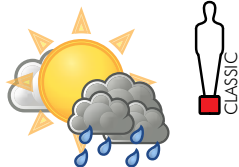

Art. S-3507 (passing rods/aste passanti)
Art. S-3507R (telescopic rods/aste rientranti)



PLAYFIELD: 114x70 cm with tempered glass 5 mm, silk-screened.
SOCCER TABLE: made of thermoplastic resins and fibres, fitted with steel bolts and nuts. Side panels 19 mm.
LEGS: strong folding legs, made of black thermoplastic resins and fibres, with anti slip adjustable rubber feet Ø 60 mm.

RODS: steel double chromed anti-rust (available only for the version with passing rods), Ø 16 mm with red/blue players made of strong plastic material fixed with a special moulding. Telescopic rods, no double chromed. Supplied with black handles "Evo Pulsar".
DOTAZIONE: Cover PRO (art. 3063P) and 10 balls included.
OPTIONS: turnable goal-keeper.

PIANO DI GIOCO: misura 114 x 70 cm in vetro temperato da 5 mm, serigrafato.
STRUTTURA: in fibra e resine termoplastiche, assemblato con bulloneria in acciaio. Spessore sponda 19 mm.
GAMBE: pieghevoli, in fibra nera termoplastica inclinate ad alta resistenza con piedini regolabili antiscivolo in gomma Ø 60 mm.
ASTE: in acciaio con doppia cromatura anti-ruggine (lavorazione disponibile solo per aste passanti), Ø 16 mm con ometti rosso/blu in materiale plastico indistruttibile fissati con stampaggio diretto. Aste rientranti no doppia cromatura. Con manopole nere "Evo Pulsar".
DOTAZIONE: Coperta Pro (art. 3063P), 10 palline.
OPTIONAL: portiere girevole.

EXTERNAL SIZES MISURE ESTERNE	WEIGHT PESO	RODS ASTE	BEARINGS BOCCOLE	HANDLES MANOPOLE
closed/chiuso 133,5 x 76,5 x h. 29 cm open/aperto 133,5 x 76,5 x h. 83 cm	64 kg.	Ø 16 mm	"Evo"	"Evo pulsar"

המרתה-F1 Outdoor

MADE IN ITALY

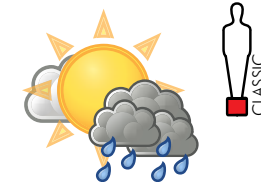

Art. S-3446 (passing rods/aste passanti)
Art. S-3446R (telescopic rods/aste rientranti)



PLAYFIELD: 114 x 70 cm with tempered glass 5 mm, silk-screened.
SOCCER TABLE: made of thermoplastic resins and fibres, fitted with steel bolts and nuts. Side panels 19 mm.
LEGS: made of thermoplastic black fibre, sloping, strong resistant with anti-slip threaded rubber feet Ø60 mm.
RODS: steel double chromed anti-rust (available only for the version with passing rods), Ø 16 mm with red/blue players made of strong plastic material fixed with a special moulding. Supplied with black handles "Evo".
OPTIONS: turnable goal-keeper.

PIANO DI GIOCO: misura 114 x 70 cm in vetro temperato da 5 mm, serigrafato.
STRUTTURA: in fibre e resine termoplastiche, assemblato con bulloneria in acciaio. Spessore sponda 19 mm.
GAMBE: in fibra nera termoplastica inclinate ad alta resistenza con piedini regolabili antiscivolo in gomma Ø 60 mm.
ASTE: in acciaio con doppia cromatura anti-ruggine (lavorazione disponibile solo per aste passanti), Ø 16 mm con ometti rosso/blu in materiale plastico indistruttibile fissati con stampaggio diretto. Aste rientranti no doppia cromatura. Con manopole nere "Evo".
OPTIONAL: portiere girevole.

EXTERNAL SIZES MISURE ESTERNE	WEIGHT PESO	RODS ASTE	BEARINGS BOCCOLE	HANDLES MANOPOLE
138 x 76 x h.85 cm.	65 kg.	Ø 16 mm	"Evo"	"Evo" black / nero

STORM-F2

MADE IN ITALY

Outdoor

Art. S-3447 (passing rods/aste passanti)

Art. S-3447R (telescopic rods/aste rientranti)

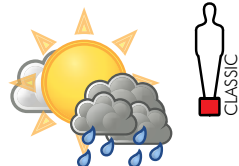

NEW

TOP PRODUCT

PLAYFIELD: 114 x 70 cm with tempered glass 5 mm, silk-screened.

SOCGER TABLE: made of thermoplastic resins and fibres, fitted with steel bolts and nuts. Side panels 19 mm.

LEGS: squared 90 x 90 mm, made of thermoplastic black fibre, strong resistant. Adjustable anti-slip rubber feet Ø 100 mm.

RODS: steel double chromed anti-rust (available only for the version with passing rods), Ø 16 mm with red/blue players made of strong plastic material fixed with a special moulding. Supplied with black handles "Evo".

OPTIONS: turnable goal-keeper.

PIANO DI GIOCO: misura 114 x 70 cm in vetro temperato da 5 mm, serigrafato.

STRUTTURA: in fibre e resine termoplastiche, assemblato con bulloneria in acciaio. Spessore sponda 19 mm.

GAMBE: quadrate 90 x 90 mm in fibra nera termoplastica ad alta resistenza. Piedini regolabili antiscivolo in gomma Ø 100 mm.

ASTE: in acciaio con doppia cromatura anti-ruggine (lavorazione disponibile solo per aste passanti), Ø 16 mm con ometti rosso/blu in materiale plastico indistruttibile fissati con stampaggio diretto. Aste rientranti no doppia cromatura. Con manopole nere "Evo".

OPTIONAL: portiere girevole.

EXTERNAL SIZES MISURE ESTERNE	WEIGHT PESO	RODS ASTE	BEARINGS BOCCOLE	HANDLES MANOPOLE
138 x 76 x h.85 cm.	77 kg.	Ø 16 mm	"Evo"	"Evo" black / nero

STORM-F3

MADE IN ITALY

Outdoor

Art. S-3448 (passing rods/aste passanti)

Art. S-3448R (telescopic rods/aste rientranti)

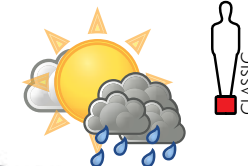

NEW

TOP PRODUCT

INTERNAL MECHANISM
MECCANISMO INTERNO

PLAYFIELD: 114x70 cm with tempered glass 5 mm, silk-screened.

SOCGER TABLE: made of thermoplastic resins and fibres, fitted with steel bolts and nuts. Side panels 19 mm. Model with G07 coin shute. Balls return system composed by elements separately replaceable.

LEGS: squared 90 x 90 mm, made of thermoplastic black fibre, strong resistant. Adjustable anti-slip rubber feet Ø 100 mm.

RODS: steel double chromed anti-rust (available only for the version with passing rods), Ø 16 mm with red/blue players made of strong plastic material fixed with a special moulding. Supplied with black handles "Evo".

OPTIONS: turnable goal-keeper - kit glass on top for F3 (art. 14635) or glass on top for F3 turnable goalkeeper (art. 14355).

PIANO DI GIOCO: misura 114 x 70 cm in vetro temperato da 5 mm, serigrafato.

STRUTTURA: in fibra e resine termoplastiche, assemblato con bulloneria in acciaio. Spessore sponda 19 mm. Modello con gettoniera G07. Sistema di ritorno palline formato da elementi sostituibili singolarmente.

GAMBE: quadrate 90 x 90 mm, in fibra nera termoplastica ad alta resistenza. Piedini regolabili professionali antiscivolo Ø 100 mm.

ASTE: in acciaio con doppia cromatura anti-ruggine (lavorazione disponibile solo per aste passanti), Ø 16 mm con ometti rosso/blu in materiale plastico indistruttibile fissati con stampaggio diretto. Aste rientranti no doppia cromatura. Con manopole nere "Evo".

OPTIONAL: portiere girevole - kit vetro sopra F3 standard (art.14635) - kit vetro sopra F3 portiere girevole (art. 14355).

EXTERNAL SIZES MISURE ESTERNE	WEIGHT PESO	RODS ASTE	BEARINGS BOCCOLE	HANDLES MANOPOLE
138 x 76 x h.88 cm.	107 kg.	Ø 16 mm	"Evo"	"Evo" black / nero

BIMBY MADE IN ITALY
by **STAN-FO** Outdoor

Art. 74856 (telescopic rods/aste rientranti)



**BALL FREE OF CHARGE
PALLINA OMAGGIO**

**BALLS DISPLAY
VETRINA ESPOSITRICE**

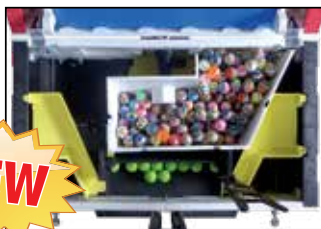

PLAYFIELD: 53 x 37 cm made of melamine.
SOCCER TABLE: made of thermoplastic resins and fibers. Suitable to remain outside all year long. Sloping legs in black fibre, protection tempered glass. Model with coin shute 1 euro.
RODS: telescopic, made of tempered steel, Ø 16 mm. Supplied with yellow handles.
GADGET DISPENSER: balls of a Ø from 32 to 36 mm. Capacity: about 450 pcs.
OPTIONS: kit of wheels (art. 14647).

PIANO DI GIOCO: misura 53 x 37 cm in melaminico.
STRUTTURA: in fibra e resine termoplastiche. Adatto per restare tutto l'anno all'aperto. Gambe inclinate in fibra nere, vetro di protezione temperato. Modello con gettoniera a 1 €. ASTE: rientranti in acciaio temperato. Ø 16 mm. Con manopole gialle.
DISTRIBUTORE DI GADGET: Palline da Ø 32 a Ø36 mm. Capienza distributore circa 450 pz.
OPTIONAL: Kit ruote (Art. 14647)

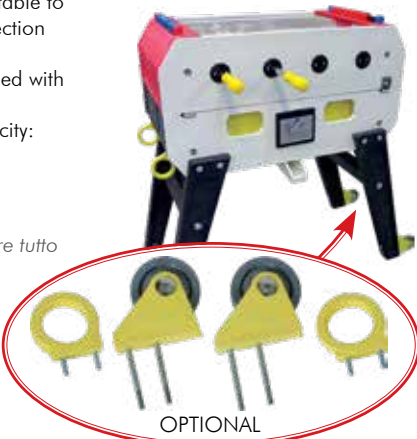

OPTIONAL

EXTERNAL SIZES MISURE ESTERNE	WEIGHT PESO	RODS ASTE	BEARINGS BOCCOLE	HANDLES MANOPOLE
77 x 41 x h.90 cm.	46 kg.	Ø 16 mm	"Evo"	yellow / gialle

STAN-FO MADE IN ITALY

Art. S-3450 (telescopic rods/aste rientranti)

Outdoor



PLAYFIELD: 53 x 38 cm made of ACP 4 mm.
SOCCER TABLE: made of thermoplastic resins and fibres. Suitable to stay outdoor all year long.
RODS: telescopic, made of tempered steel, Ø 16 mm. Supplied with yellow handles.
10 balls included.
Supplied completely disassembled with easy mounting instructions.

PIANO DI GIOCO: misura 53 x 38 cm in ACP da 4 mm.
STRUTTURA: in fibra e resine termoplastiche. Adatto per restare tutto l'anno all'aperto.
ASTE: rientranti in acciaio temperato. Ø 16 mm. Con manopole gialle.
10 palline incluse.
Fornito completamente disassemblato con pratiche istruzioni di montaggio.

EXTERNAL SIZES MISURE ESTERNE	WEIGHT PESO	RODS ASTE	BEARINGS BOCCOLE	HANDLES MANOPOLE
59 x 42 x h.78 cm.	16 kg.	Ø 16 mm	"Evo"	yellow / gialle

COSMO VS - Indoor

Art. S-3605 (passing rods/aste passanti)
 Art. S-3605R (telescopic rods/aste rientranti)

STADIUM
 LINE

MADE IN ITALY



PLAYFIELD: 114 x 70 cm with tempered glass 5 mm, with plastic green paper reproducing the soccer table playfield.

SOCCER TABLE: made of plywood plated with 26 mm plastic laminate, corners in black anodized aluminium. Model with G07 coinshute. Supplied with a ball return system studied to prevent thefts. With four plastic bottle trays. Finishing in printed PVC wrap with wood effect.

COVER: made of tempered glass 5 mm which allows a total protection against thefts and tampering.

LEGS: squared 90 x 90 mm, made of steel, black powder coated varnished with ABS footbed.

RODS: made of chromed steel, Ø 16 mm with red/blue players made of strong plastic material fixed with a special moulding. Supplied with black handles "Evo".

OPTIONAL: adjustable feet (art.18401)

PIANO DI GIOCO: misura 114 x 70 cm in vetro temperato da 5 mm, con foglio plastificato effetto erba.

STRUTTURA: in compensato multistrato rivestito in laminato plastico da 26 mm. Cantonali in alluminio anodizzato nero. Modello con gettoniera G07. Dotato di un sistema di sicurezza rilascio palline antifrode. Con 4 porta bottiglie in plastica. Finitura in pellicola PVC stampata con effetto legno.

COPERTURA: in vetro temperato da 5 mm che consente una protezione totale contro furti e manomissioni.

GAMBE: quadrate 90 x 90 mm, in acciaio verniciate a polvere epossidica nera con sottopiede in ABS.

ASTE: in acciaio cromato, Ø 16 mm con ometti rosso/blu in materiale plastico indistruttibile fissati con stampaggio diretto. Con manopole nere "Evo".

OPTIONAL: piedino regolabile (art.18401)

EXTERNAL SIZES MISURE ESTERNE	WEIGHT PESO	RODS ASTE	BEARINGS BOCCOLE	HANDLES MANOPOLE
140 x 78 x h.99 cm.	96 kg.	Ø 16 mm	"Evo"	"Evo" black / nero

COSMO VS PLUS - Indoor

Art. S-3606 (passing rods/aste passanti)
 Art. S-3606R (telescopic rods/aste rientranti)

STADIUM
 LINE

MADE IN ITALY



LED playingfield lightning

Illuminazione del piano di gioco con luci LED



With electronic system (art.15928)

- Electronic coinshute RM5 (Comestero) with the possibility to program until 6 different coins
- electronic counter
- bonus matches
- 220V power supply.

Dotato di sistema elettronico (art.15928)

- Gettoniera elettronica RM5 (Comestero) con possibilità di programmare fino a 6 monete diverse
- contatore elettronico
- bonus partite
- alimentato 220V.



BLACK MONSTER - Indoor

Art. S-3480 (passing rods/aste passanti)

Art. S-348R (telescopic rods/aste rientranti)

STADIUM
LINE

MADE IN ITALY



REINFORCE IRON BARS
BARRE DI RINFORZO IN FERRO

PLAYFIELD: 114 x 70 cm made of multilayered wood double plated with green plastic laminate. Without corners to grant a perfect uniformity of the playfield. Reinforce iron bars to guarantee a crushproof playfield. ABS goals with internal shaped metal sheet.

SOCCER TABLE: made of multilayered wood and plastic black glossy laminate. Side panels 30 mm. With G07 coinshute and shock absorbent black rubber profiles.

LEGS: squared 90 x 90 mm, made of steel, black powder coated varnished with crossbeam support.

Adjustable feet for a perfect balance, made of anti-slip rubber, Ø 100 mm.

RODS: made of chromed steel, Ø 16 mm with red/blue players made of strong plastic material fixed with a special moulding. Supplied with gray handles "Evo".

PIANO DI GIOCO: misura 114 x 70 cm, in multistrato da 19 mm con doppio rivestimento in laminato plastico verde, postformato senza angolari per una perfetta uniformità del piano. Barre di rinforzo in ferro per un piano indeformabile. Porte in ABS con profilo in linea con il mobile con interno in lamiera sagomata.

STRUTTURA: in multistrato e laminato plastico nero lucido. Spessore sponda 30 mm. Con gettoniera G07 e profili in gomma antiurto nera.

GAMBE: quadrate 90 x 90 mm, in acciaio verniciate a polvere epossidica nera con traverso di rinforzo.

Piedini regolabili per un perfetto livellamento, in gomma antiscivolo Ø 100 mm.

ASTE: in acciaio cromato, Ø 16 mm con ometti rosso/blu in materiale plastico indistruttibile fissati con stampaggio diretto. Con manopole grigie "Evo".

EXTERNAL SIZES MISURE ESTERNE	WEIGHT PESO	RODS ASTE	BEARINGS BOCCOLE	HANDLES MANOPOLE
140 x 75 x h.92 cm.	92 kg.	Ø 16 mm	"Laser"	"Evo" gray/grigio

STADIUM PRO ITALY - Indoor

Art. S-3359 (passing rods/aste passanti)

Art. S-3359R (telescopic rods/aste rientranti)

STADIUM
LINE

MADE IN ITALY



RUBBER/PLASTIC HANDLE
"EVO", GRAY.
MANOPOLA "EVO" IN
GOMMA/PLASTICA, GRIGIA.

PLAYFIELD: 114 x 70 cm with tempered glass 5 mm, with plastic green paper reproducing the soccer table playfield.

SOCCER TABLE: made of plywood plated with 30 mm plastic white laminate, corners in black anodized aluminium. Model with G07 coinshute. Supplied with low corners 20 mm and steel goals as FIBIL rules.

LEGS: squared 90 x 90 mm, made of steel, black powder coated varnished with crossbeam support.

Adjustable feet for a perfect balance, made of anti-slip rubber, Ø 100 mm.

RODS: made of chromed steel, Ø 16 mm with red/blue players made of strong plastic material fixed with a special moulding. Supplied with gray handles "Evo".

PIANO GIOCO: misura 114 x 70 cm in vetro temperato da 5 mm, con foglio plastificato effetto erba.

STRUTTURA: in compensato multistrato rivestito in laminato plastico bianco da 30 mm. Cantonali in alluminio anodizzato nero. Modello con gettoniera G07. Dotato di angolari bassi da 20 mm e porte in acciaio come da regolamento FIBIL.

GAMBE: quadrate 90 x 90 mm, in acciaio verniciate a polvere epossidica nera con traverso di rinforzo.

Piedini regolabili per un perfetto livellamento, in gomma antiscivolo Ø 100 mm.

ASTE: in acciaio cromato, Ø 16 mm con ometti rosso/blu in materiale plastico indistruttibile fissati con stampaggio diretto. Con manopole grigie "Evo".

EXTERNAL SIZES MISURE ESTERNE	WEIGHT PESO	RODS ASTE	BEARINGS BOCCOLE	HANDLES MANOPOLE
140 x 75 x h.92 cm.	81 kg.	Ø 16 mm	"Slide"	"Evo" gray/grigio

STADIUM PRO - Indoor

Art. S-3348 (passing rods/aste passanti)
Art. S-3348R (telescopic rods/aste rientranti)

STADIUM
LINE
MADE IN ITALY



OPENING SYSTEM
SISTEMA DI APERTURA

PLAYFIELD: 114 x 70 cm with tempered glass 5 mm, with plastic green paper reproducing the soccer table playfield.
SOCCER TABLE: made of plywood plated with 26 mm plastic laminate, corners in black anodized aluminium. Model with G07 coinshute. Easy opening system and mechanic lock. Dark grey/marbled version.
LEGS: squared 90 x 90 mm, made of steel, black powder coated varnished with crossbeam support. Adjustable feet for a perfect balance, made of anti-slip rubber, Ø 100 mm.
RODS: made of chromed steel, Ø 16 mm with red/blue players made of strong plastic material fixed with a special moulding. Supplied with black handles "Evo".
OPTIONS: glass on top kit including a safety device for balls (art.14547).

PIANO DI GIOCO: misura 114 x 70 cm in vetro temperato da 5 mm, con foglio plastificato effetto erba.
STRUTTURA: in compensato multistrato rivestito in laminato plastico da 30 mm. Cantonali in alluminio anodizzato nero. Modello con gettoniera G07. Facile sistema di apertura e bloccaggio meccanico. Finitura grigia scura marmorizzata.
GAMBE: quadrate 90 x 90 mm, in acciaio verniciate a polvere epossidica nera con traverso di rinforzo. Piedini regolabili per un perfetto livellamento, in gomma antiscivolo Ø 100 mm.
ASTE: in acciaio cromato, Ø 16 mm con ometti rosso/blu in materiale plastico indistruttibile fissati con stampaggio diretto. Con manopole nere "Evo".
OPTIONAL: Kit vetro sopra incluso un sistema di sicurezza per le palline (art.14547).

EXTERNAL SIZES MISURE ESTERNE	WEIGHT PESO	RODS ASTE	BEARINGS BOCCOLE	HANDLES MANOPOLE
140 x 75 x h.92 cm.	81 kg.	Ø 16 mm	"Slide"	"Evo" black / nero

STADIUM PRO-VS - Indoor

Art. S-3358 (passing rods/aste passanti)
Art. S-3358R (telescopic rods/aste rientranti)

STADIUM
LINE
MADE IN ITALY



4 BOTTLE TRAYS
4 PORTA BOTTIGLIE

PLAYFIELD: 114 x 70 cm with tempered glass 5 mm, with plastic green paper reproducing the soccer table playfield.
SOCCER TABLE: made of plywood plated with 30 mm plastic laminate, corners in black anodized aluminium. Model with G07 coinshute. Supplied with a ball return system studied to prevent thefts and four bottle trays. Dark grey/marbled version.
COVER: made of tempered glass 5 mm which allows a total protection against thefts and tampering.
LEGS: squared 90 x 90 mm, made of steel, black powder coated varnished with crossbeam support. Adjustable feet for a perfect balance, made of anti-slip rubber, Ø 100 mm.
RODS: made of chromed steel, Ø 16 mm with red/blue players made of strong plastic material fixed with a special moulding. Supplied with black handles "Evo".

PIANO DI GIOCO: misura 114 x 70 cm in vetro temperato da 5 mm, con foglio plastificato effetto erba.
STRUTTURA: in compensato multistrato rivestito in laminato plastico da 30 mm. Cantonali in alluminio anodizzato nero. Modello con gettoniera G07. Dotato di un sistema di sicurezza rilascio palline antifrode e 4 porta bottiglie in plastica. Finitura grigia scura marmorizzata.
COPERTURA: in vetro temperato da 5 mm che consente una protezione totale contro furti e manomissioni.
GAMBE: quadrate 90 x 90 mm, in acciaio verniciate a polvere epossidica nera con traverso di rinforzo. Piedini regolabili per un perfetto livellamento, in gomma antiscivolo Ø 100 mm.
ASTE: in acciaio cromato, Ø 16 mm con ometti rosso/blu in materiale plastico indistruttibile fissati con stampaggio diretto. Con manopole nere "Evo".

EXTERNAL SIZES MISURE ESTERNE	WEIGHT PESO	RODS ASTE	BEARINGS BOCCOLE	HANDLES MANOPOLE
142 x 78 x h.97 cm.	102 kg.	Ø 16 mm	"Slide"	"Evo" black / nero

STADIUM - Indoor

Art. S-3330 (passing rods/aste passanti)
Art. S-3330R (telescopic rods/aste rientranti)

STADIUM
LINE
MADE IN ITALY



PLAYFIELD: 114 x 70 cm with tempered glass 5 mm, with plastic green paper reproducing the soccer table playfield.

SOCCER TABLE: made of plywood plated with 26 mm plastic laminate, corners in black anodized aluminium. Model with G07 coinshute. Balls return system composed by metallic elements which are separately replaceable. Black/yellow version.

LEGS: squared 90 x 90 mm, made of steel, black powder coated varnished with ABS footbed.

RODS: made of chromed steel, diameter 16 mm with red/blue players made of strong plastic material fixed with a special moulding. Supplied with black handles "Evo".

OPTIONS: glass on top kit including a safety device for balls (art.14547). Adjustable feet (art.18401)

PIANO DI GIOCO: misura 114 x 70 cm in vetro temperato da 5 mm, con foglio plastificato effetto erba.

STRUTTURA: in compensato multistrato rivestito in laminato plastico da 26 mm. Cantonali in alluminio anodizzato nero. Modello con gettoniera G07. Sistema di ritorno palline formato da elementi metallici sostituibili singolarmente. Finitura nero/gialla.

GAMBE: quadrate 90 x 90 mm, in acciaio verniciate a polvere epossidica nera con sottopiede in ABS.

ASTE: in acciaio cromato, Ø 16 mm con ometti rosso/blu in materiale plastico indistruttibile fissati con stampaggio diretto. Con manopole nere "Evo".

OPTIONAL: Kit vetro sopra incluso un sistema di sicurezza per le palline (art.14547). Piedino regolabile (art.18401)

EXTERNAL SIZES MISURE ESTERNE	WEIGHT PESO	RODS ASTE	BEARINGS BOCCOLE	HANDLES MANOPOLE
140 x 75 x h.91 cm.	77 kg.	Ø 16 mm	"Evo"	"Evo" black / nero

STADIUM VS - Indoor

Art. S-3353 (passing rods/aste passanti)
Art. S-3353R (telescopic rods/aste rientranti)

STADIUM
LINE
MADE IN ITALY



4 BOTTLE TRAYS
4 PORTA BOTTIGLIE

PLAYFIELD: 114 x 70 cm with tempered glass 5 mm, with plastic green paper reproducing the soccer table playfield.

SOCCER TABLE: made of plywood plated with 26 mm plastic laminate, corners in black anodized aluminium. Model with G07 coinshute. Supplied with a ball return system studied to prevent thefts. With four bottle trays. Black/yellow version.

COVER: made of tempered glass 5 mm which allows a total protection against thefts and tampering.

LEGS: squared 90 x 90 mm, made of steel, black powder coated varnished with ABS footbed.

RODS: made of chromed steel, Ø 16 mm with red/blue players made of strong plastic material fixed with a special moulding. Supplied with black handles "Evo".

OPTIONS: Adjustable feet (art.18401)

PIANO DI GIOCO: misura 114 x 70 cm in vetro temperato da 5 mm, con foglio plastificato effetto erba.

STRUTTURA: in compensato multistrato rivestito in laminato plastico da 26 mm. Cantonali in alluminio anodizzato nero. Modello con gettoniera G07. Dotato di un sistema di sicurezza rilascio palline antifrode. Con 4 porta bottiglie in plastica. Finitura nero/gialla.

COPERTURA: in vetro temperato da 5 mm che consente una protezione totale contro furti e manomissioni.

GAMBE: quadrate 90 x 90 mm, in acciaio verniciate a polvere epossidica nera con sottopiede in ABS.

ASTE: in acciaio cromato, Ø 16 mm con ometti rosso/blu in materiale plastico indistruttibile fissati con stampaggio diretto. Con manopole nere "Evo".

OPTIONAL: Piedino regolabile (art.18401)

EXTERNAL SIZES MISURE ESTERNE	WEIGHT PESO	RODS ASTE	BEARINGS BOCCOLE	HANDLES MANOPOLE
140 x 78 x h.99 cm.	96 kg.	Ø 16 mm	"Evo"	"Evo" black / nero

STADIUM FAMILY (Oak/Rovere) - Indoor

Art. S-3354 (passing rods/aste passanti)
Art. S-3354R (telescopic rods/aste rientranti)

STADIUM
LINE
MADE IN ITALY

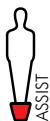

PLAYFIELD: 114 x 70 cm with tempered glass 5 mm, with plastic green paper reproducing the soccer table playfield.

SOCCER TABLE: made of MDF oak colour. Side panels 25 mm.

LEGS: squared 90 x 90 mm, made of steel, black powder coated varnished with ABS footbed.

RODS: made of chromed steel, Ø 16 mm with red/blue players made of strong plastic material fixed with a special moulding. Supplied with black handles "Evo".

OPTIONS: rubber adjustable foot (art. 18401).

PIANO DI GIOCO: misura 114 x 70 cm in vetro temperato da 5 mm, con foglio plastificato effetto erba.

STRUTTURA: in MDF rivestito in melaminico colore rovere. Spessore sponde 25 mm.

GAMBE: quadrate 90 x 90 mm, in acciaio verniciate a polvere epossidica nera con sottopiede in ABS.

ASTE: in acciaio cromato, Ø 16 mm con ometti rosso/blu in materiale plastico indistruttibile fissati con stampaggio diretto. Con manopole nere "Evo".

OPTIONAL: piedino regolabile in gomma (art. 18401).

EXTERNAL SIZES MISURE ESTERNE	WEIGHT PESO	RODS ASTE	BEARINGS BOCCOLE	HANDLES MANOPOLE
140 x 75 x h.88 cm.	73 kg.	Ø 16 mm	"Evo"	"Evo" black / nero

STADIUM FAMILY (Red/Rosso) - Indoor

Art. S-3441 (passing rods/aste passanti)
Art. S-3441R (telescopic rods/aste rientranti)

STADIUM
LINE
MADE IN ITALY



PLAYFIELD: 114 x 70 cm with tempered glass 5 mm, with plastic green paper reproducing the soccer table playfield.

SOCCER TABLE: made of MDF red colour. Side panels 25 mm.

LEGS: squared 90 x 90 mm, made of steel, black powder coated varnished with ABS footbed.

RODS: made of chromed steel, Ø 16 mm with red/blue players made of strong plastic material fixed with a special moulding. Supplied with black handles "Evo".

OPTIONS: rubber adjustable foot (art. 18401).

PIANO DI GIOCO: misura 114 x 70 cm in vetro temperato da 5 mm, con foglio plastificato effetto erba.

STRUTTURA: in MDF rivestito in melaminico colore rosso. Spessore sponde 25 mm.

GAMBE: quadrate 90 x 90 mm, in acciaio verniciate a polvere epossidica nera con sottopiede in ABS.

ASTE: in acciaio cromato, Ø 16 mm con ometti rosso/blu in materiale plastico indistruttibile fissati con stampaggio diretto. Con manopole nere "Evo".

OPTIONAL: piedino regolabile in gomma (art. 18401).

EXTERNAL SIZES MISURE ESTERNE	WEIGHT PESO	RODS ASTE	BEARINGS BOCCOLE	HANDLES MANOPOLE
140 x 75 x h.88 cm.	73 kg.	Ø 16 mm	"Evo"	"Evo" black / nero

STADIUM FAMILY (White/Bianco) - Indoor

Art. S-3503 (passing rods/aste passanti)
 Art. S-3503R (telescopic rods/aste rientranti)

STADIUM
 LINE
 MADE IN ITALY

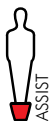

PLAYFIELD: 114 x 70 cm with tempered glass 5 mm, with plastic green paper reproducing the soccer table playfield.
 SOCCER TABLE: made of MDF white colour. Side panels 25 mm.
 LEGS: squared 90 x 90 mm, made of steel, black powder coated varnished with ABS footbed.
 RODS: made of chromed steel, Ø 16 mm with red/blue players made of strong plastic material fixed with a special moulding. Supplied with black handles "Evo".
 OPTIONS: rubber adjustable foot (art. 18401).

PIANO DI GIOCO: misura 114 x 70 cm in vetro temperato da 5 mm, con foglio plastificato effetto erba.
 STRUTTURA: in MDF rivestito in melaminico colore bianco. Spessore sponde 25 mm.
 GAMBE: quadrate 90 x 90 mm, in acciaio verniciate a polvere epossidica nera con sottopiede in ABS.
 ASTE: in acciaio cromato, Ø 16 mm con ometti rosso/blu in materiale plastico indistruttibile fissati con stampaggio diretto. Con manopole nere "Evo".
 OPTIONAL: piedino regolabile in gomma (art. 18401).

EXTERNAL SIZES MISURE ESTERNE	WEIGHT PESO	RODS ASTE	BEARINGS BOCCOLE	HANDLES MANOPOLE
140 x 75 x h.88 cm.	73 kg.	Ø 16 mm	"Evo"	"Evo" black / nero

STADIUM FAMILY (Black/Nero) - Indoor

Art. S-3504 (passing rods/aste passanti)
 Art. S-3504R (telescopic rods/aste rientranti)

STADIUM
 LINE
 MADE IN ITALY



PLAYFIELD: 114 x 70 cm with tempered glass 5 mm, with plastic green paper reproducing the soccer table playfield.
 SOCCER TABLE: made of MDF black colour. Side panels 25 mm.
 LEGS: squared 90 x 90 mm, made of steel, black powder coated varnished with ABS footbed.
 RODS: made of chromed steel, Ø 16 mm with red/blue players made of strong plastic material fixed with a special moulding. Supplied with black handles "Evo".
 OPTIONS: rubber adjustable foot (art. 18401).

PIANO DI GIOCO: misura 114 x 70 cm in vetro temperato da 5 mm, con foglio plastificato effetto erba.
 STRUTTURA: in MDF rivestito in melaminico colore nero. Spessore sponde 25 mm.
 GAMBE: quadrate 90 x 90 mm, in acciaio verniciate a polvere epossidica nera con sottopiede in ABS.
 ASTE: in acciaio cromato, Ø 16 mm con ometti rosso/blu in materiale plastico indistruttibile fissati con stampaggio diretto. Con manopole nere "Evo".
 OPTIONAL: piedino regolabile in gomma (art. 18401).

EXTERNAL SIZES MISURE ESTERNE	WEIGHT PESO	RODS ASTE	BEARINGS BOCCOLE	HANDLES MANOPOLE
140 x 75 x h.88 cm.	73 kg.	Ø 16 mm	"Evo"	"Evo" black / nero

STELVIO - Indoor

Art. S-3604 (passing rods/aste passanti)
Art. S-3604R (telescopic rods/aste rientranti)

STADIUM
LINE
MADE IN ITALY



PLAYFIELD: 114 x 70 cm made of mdf 19 cm covered with green melamine with silkscreened playingfield.
SOCCER TABLE: made of white mdf with black absorbent schock pvc border. Side panels 25 mm.
LEGS: in highly resistant thermoplastic with foldable closing system. Equipped by wheels placed on the 4 support pints to move it easily (see the picture). With anti-slip threaded rubber feet Ø53 mm for a perfect leveling.

RODS: made of chromed steel, Ø16 mm with red/blue players made of strong plastic material fixed with a special moulding. Supplied with black handles "Evo".

PIANO DI GIOCO: 14 X 70 cm in MDF da 19 mm rivestito in melaminico color verde con serigrafia campo gioco

STRUTTURA: in MEF color bianco bordato con profilo in PVC antiurto nero. Spessore sponde 25 mm.

GAMBE: in fibra termoplastica ad alta resistenza con sistema di chiusura pieghevole. Dotato di ruote sui 4 punti di appoggio per facilitare lo spostamento. Piedini regolabili per un perfetto livellamento, in gomma antiscivolo Ø53 mm

ASTE: in acciaio cromato Ø16 mm con ometti rosso/blu in materiale plastico indistruttibile fissati con stampaggio diretto. Con manopole nere "Evo".

EXTERNAL SIZES MISURE ESTERNE	WEIGHT PESO	RODS ASTE	BEARINGS BOCCOLE	HANDLES MANOPOLE
126 x 75 x h.87 cm.	53 kg.	Ø 16 mm	"Evo"	"Evo" black / nero

LEVANTE - Indoor

Art. S-3595 (passing rods/aste passanti)
Art. S-3595R (telescopic rods/aste rientranti)

STADIUM
LINE
MADE IN ITALY



PLAYFIELD: 114 x 70 cm made of MDF covered with green melamine with silkscreened playingfield.

SOCCER TABLE: made of MDF with black profile. Side panels 25 mm.

LEGS: made of resistant plastic with adjustable threaded foot.

RODS: made of chromed steel, Ø 16 mm with red/blue players made of strong plastic material fixed with a special moulding. Supplied with black handles "Evo".

PIANO DI GIOCO: misura 114 x 70 cm in MDF rivestito in melaminico color verde con serigrafia campo gioco.

STRUTTURA: in MDF con profilo nero. Spessore sponde 25 mm.

GAMBE: in plastica resistente con piedino autofilettante regolabile.

ASTE: in acciaio cromato, Ø 16 mm con ometti rosso/blu in materiale plastico indistruttibile fissati con stampaggio diretto. Con manopole nere "Evo".

EXTERNAL SIZES MISURE ESTERNE	WEIGHT PESO	RODS ASTE	BEARINGS BOCCOLE	HANDLES MANOPOLE
126 x 75 x h.87 cm.	55 kg.	Ø 16 mm	"Evo"	"Evo" black / nero

SPACE - Indoor

Art. S-3476 (passing rods/aste passanti)
Art. S-3476R (telescopic rods/aste rientranti)

STADIUM
LINE
MADE IN ITALY

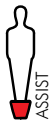

PLAYFIELD: 114 x 70 cm made of multilayered covered with formica.
SOCCER TABLE: made of multilayered covered with black coloured formica with rounded profiles covered with shock absorbent PVC. Side panels 25 mm.
LEGS: made of steel, black powder coated varnished.
RODS: made of chromed steel, Ø 16 mm with red/blue players made of strong plastic material fixed with a special moulding. Supplied with black handles "Evo".

PIANO DI GIOCO: misura 114 x 70 cm in multistrato rivestito in formica.
STRUTTURA: in materiale multistrato rivestito in formica color nera con profili arrotondati e rivestimenti in PVC antiurto. Spessore sponde 25 mm.
GAMBE: in acciaio verniciate a polvere epossidica nera.
ASTE: in acciaio cromato, Ø 16 mm con ometti rosso/blu in materiale plastico indistruttibile fissati con stampaggio diretto. Con manopole nere "Evo".

EXTERNAL SIZES MISURE ESTERNE	WEIGHT PESO	RODS ASTE	BEARINGS BOCCOLE	HANDLES MANOPOLE
closed/chiuso 146 x 76 x h. 30 cm open/aperto 146 x 76 x h. 90 cm	49 kg.	Ø 16 mm	"Evo"	"Evo" black / nero

LUSTIG - Indoor

Art. 3525 (telescopic rods/aste rientranti)



PLAYFIELD: 119x68 cm, made of MDF 9 mm with silkscreened playingfield and two support rods.
SOCCER TABLE: made of MDF covered with PVC, light oak coloured. Side panels 36 mm.
LEGS: made of MDF, covered with black laminate, adjustable feet.
RODS: telescopic rods, chromed steel 15,8 mm with printed red/black players
NET WEIGHT: 58 kg
2 soccer balls included.
Supplied completely disassembled with easy mounting instructions.

PIANO DI GIOCO: misura 119 x 68 cm in MDF da 9 mm con serigrafia sul campo gioco e con due barre di supporto.
STRUTTURA: in MDF rivestito in PVC color rovere chiaro. Spessore sponde 36 mm.
GAMBE: in MDF rivestite in laminato nero con piedini regolabili.
ASTE: telescopiche in acciaio cromato da 15,8 mm con ometti color rosso nero controbilanciati stampati sulle aste.
PESO NETTO: 58 kg
2 palline incluse.
Fornito completamente disassemblato con pratiche istruzioni di montaggio.

EXTERNAL SIZES / MISURE ESTERNE	WEIGHT / PESO	RODS / ASTE	BEARINGS / BOCCOLE
143,5 x 75 x h.91 cm.	58 kg.	Ø 15,8 mm	con cuscinetti a rulli

STARK - Indoor

Art. 3527 (telescopic rods/aste rientranti)
Art. S-3359P (passing rods/aste passanti)

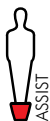

TOP PRODUCT

PLAYFIELD: 118x68 cm, made of MDF 9 mm with silkscreened playingfield and two support rods.
SOCCER TABLE: made of MDF covered with PVC, blue coloured with silver coloured profiles. Side panels 30 mm.
LEGS: made of MDF, 95x95 mm covered with black laminate, anti-slip rubber feet.
RODS: telescopic rods, chromed steel 15,8 mm with screwed yellow/blue players
NET WEIGHT: 49 kg
2 soccer balls included
Supplied completely disassembled with easy mounting instructions.

PIANO DI GIOCO: misura 118x68 cm in MDF da 9 mm con serigrafia sul campo gioco e con due barre di supporto.

STRUTTURA: in MDF rivestito in PVC color blu con profili argento. Spessore sponde 30 mm.

GAMBE: in MDF 95x95 cm rivestite in laminato nero con piedini in gomma antiscivolo.

ASTE: rientranti in acciaio cromato da 15,8 mm con ometti color giallo blu controbilanciati avvitati.

PESO NETTO: 49 kg

2 palline incluse.

Fornito completamente disassemblato con pratiche istruzioni di montaggio.

EXTERNAL SIZES / MISURE ESTERNE	WEIGHT / PESO	RODS / ASTE	BEARINGS / BOCCOLE
142 x 74 x h.88 cm.	49 kg.	Ø 15,8 mm	con cuscinetti a rulli

SCHÖN - Indoor

Art. 3526 (telescopic rods/aste rientranti)



TOP PRODUCT

PLAYFIELD: 118x68 cm, made of MDF 9 mm with silkscreened playingfield and two support rods.
SOCCER TABLE: made of MDF covered with PVC, dark grey coloured with silver coloured profiles. Side panels 30 mm.
LEGS: made of MDF, 95x95 mm covered with silver laminate, adjustable feet.
RODS: telescopic rods, chromed steel 15,8 mm with printed red/grey players
NET WEIGHT: 48 kg
2 soccer balls included
Supplied completely disassembled with easy mounting instructions.

PIANO DI GIOCO: misura 118x68 cm in MDF da 9 mm con serigrafia sul campo gioco e con due barre di supporto.

STRUTTURA: in MDF rivestito in PVC color grigio scuro con profili argento. Spessore sponde 30 mm.

GAMBE: in MDF 95x95 cm rivestite in laminato argento con piedini regolabili.

ASTE: telescopiche in acciaio cromato da 15,8 mm con ometti color rosso grigio controbilanciati stampati sulle aste.

PESO NETTO: 48 kg

2 palline incluse.

Fornito completamente disassemblato con pratiche istruzioni di montaggio.

EXTERNAL SIZES / MISURE ESTERNE	WEIGHT / PESO	RODS / ASTE	BEARINGS / BOCCOLE
142 x 74 x h.88 cm.	48 kg.	Ø 15,8 mm	con cuscinetti a rulli

SPARE PARTS STORM LINE / PARTI RICAMBIO LINEA STORM



Art. 300548
Spare part for soccertable Storm F3
Alzapalline per calcetto Storm F3



Art. 300558
Spare part for soccertable Storm F2
Alzapalline per calcetto Storm F2

Art. 300429
Leg for Storm F1
Gamba per calcetto Storm F1

Art. L362
Plastic leg black 90x90 for soccer table Storm F2-F3
Gamba in plastica nero 90x90 x calcetto Storm F2-F3



Art. 300555
Black side upper panel for soccer tables line Storm
Paramano nero in plastica per calcetto Storm



Art. 300556
Black plastic little part for long cushion soccer table F1
Inserto nero in plastica per sponda lunga Storm F1



Art. 300534
Side part for soccer table Storm F1 red
Cuffia per calcetto Storm F1 rossa



Art. 300541 - minimum/minimo 50 pcs/pz
Side part for soccer table Storm F1 green
Cuffia per calcetto Storm F1 verde



Art. 300537
Side part for soccer table Storm F2-F3 red
Cuffia per calcetto Storm F2-F3 rossa

STADIUM SOCCER-TABLES LINE IS A "RENZO & PIERLUIGI LONGONI" PROJECT



I CALCETTI DELLA LINEA STADIUM SONO UN PROGETTO BY "RENZO & PIERLUIGI LONGONI"

MODEL MODELLO	PIECES FOR EACH PALLET PEZZI PER PALLET	PACKAGING SIZES* INGOMBRO IMBALLO*	NUMBER OF PACKAGES COLLI	PACKAGING WEIGHT PESO IMBALLO	PIECES INCLUDED IN A 20' CONTAINER PEZZI PER 20' CONTAINER
TROLLEY	6	146 x 84 x 29 cm	1	69 kg	85
STORM F1	6	146 x 84 x 29 cm	1	70 kg	85
STORM F2	6	147 x 84 x 38 cm	1	82 kg	66
STORM F3	4	144 x 83 x 42 cm	1	112 kg	60
BIMBY	8	81 x 53 x 53 cm	1	51 kg	-
STORM F0	-	64 x 43 x 14 cm	1	21 kg	-
COSMO VS	4	152 x 79 x 47 cm	1	101 kg	57
COSMO VS PLUS	4	152 x 79 x 47 cm	1	101 kg	57
BLACK MONSTER	4	152 x 79 x 48 cm	1	97 kg	57
STADIUM PRO ITALY	4	152 x 79 x 40 cm	1	86 kg	66
STADIUM PRO	4	152 x 79 x 40 cm	1	86 kg	66
STADIUM PRO VS	4	152 x 79 x 46 cm	1	107 kg	57
STADIUM	4	152 x 79 x 40 cm	1	82 kg	66
STADIUM VS	4	152 x 79 x 47 cm	1	101 kg	57
STADIUM FAMILY	6	146 x 84 x 36 cm	1	78 kg	70
STELVIO	6	138 x 83 x 28 cm	1	58 kg	86
LEVANTE	6	146 x 84 x 29 cm	1	60 kg	86
SPACE	6	151 x 79 x 31 cm	1	54 kg	57
LUSTIG	6	153 x 77 x 18cm	1	62 kg	141
STARK	8	148 x 85 x 15,4 cm	1	53 kg	161
SCHÖN	8	148 x 85 x 15,4 cm	1	54 kg	161

* Rods kit included / Kit di aste incluso



Tam tam & accessories

Tam tam & accessori

TAM TAM - Indoor

Art. 18110



PRODUCT: Model with coin shute, made of multilayered wood covered with plastic laminate.
Side panel thickness 26 mm
PLAYINGFIELD: size 120x62 cm of formica
EXTERNAL SIZES: 170x66,5x h.93 cm
PACKAGING SIZES: 175x71,5x h.48 cm
WEIGHT: 56 kg

MOBILE: modello con gettoniera. Mobile in legno multistrato ricoperto di laminato plastico, finiture di alta qualità. Spessore sponde 26 mm
PIANO DI GIOCO: misure 120x62 cm in formica
MISURE ESTERNE: 170x66,5x h.93 cm
MISURE IMBALLO: 175x71,5x h.48 cm
PESO: 56 kg



Art. 18120
Shovel for tam tam
Pala per tam tam



art. 11141 - Ø16 mm
Conic spring for passing rods
Molla conica aste passanti

Art. 18121
Rod for tam tam shovel Ø1,3 cm length 62,5 cm
Asta per pale tam tam Ø1,3 cm lungh. 62,5 cm

TAM TAM TOUCH DOWN - Indoor

Art. 18188



PRODUCT: Made of ennobled chipboard. Side panel thickness 25 mm. Iron legs.
PLAYINGFIELD: size 114x70 cm of green printed ennobled melamine.
RODS: Ø16 mm
EXTERNAL SIZES: 145x68,5x h.100 cm
PACKAGING SIZES: 145x80x h.60 cm
WEIGHT: 40 kg

*colours can change without any previous notice

MOBILE: in legno truciolare nobilitato. Spessore sponde 25 mm. Gambe in ferro.
PIANO DI GIOCO: misure 114x70 cm in nobilitato melaminico verde serigrafato
ASTE: Ø16 mm
MISURE ESTERNE: 145x68,5x h.100 cm
MISURE IMBALLO: 145x80x h.60 cm
PESO: 40 kg

*variazioni di colori possibili



Soccer tables accessories
Accessori calcetto

Art. 3063
 Plastic cover for standard
 soccetable.
 Mixed colours
*Coperta in plastica per calcetto
 standard.
 Colori assortiti*



Art. 3560 - Cover Deluxe
 - Coperta in PVC 20 gr impermeabile, felpata e
 plastificata.
 - Color grigio con rifiniture bordi a vista in tessuto.
 - Materiale ad alta resistenza ideale per ambienti esterni
 - Dimensioni: 150x117x40 cm
 - Peso: 1300 gr
 - Adattabile ad ogni tipo di modello



Art. 3560 - Coperta Deluxe
 - Coperta in PVC 20 gr impermeabile, felpata e
 plastificata.
 - Color grigio con rifiniture bordi a vista in tessuto.
 - Materiale ad alta resistenza ideale per ambienti
 esterni
 - Dimensioni: 150x117x40 cm
 - Peso: 1300 gr
 - Adattabile ad ogni tipo di modello



Art. 3063P - Cover Pro
 - Waterproof cover
 - Grey colour with borders
 - High resistance material mainly suitable for
 outdoor use
 - Sizes: 150x117x40 cm
 - Suitable for every kind of soccetable model

Art. 3063P - Coperta Pro
 - Coperta in tela impermeabile
 - Color grigio con rifiniture bordi a vista
 - Materiale ad alta resistenza ideale
 per ambienti esterni
 - Dimensioni: 150x117x40 cm
 - Adattabile ad ogni tipo di modello



GLASS ON TOP KIT "UNIVERSAL" KIT VETRO SOPRA "UNIVERSAL"	
14547	Standard
14547PG	For revolving goal keeper / Per portiere girevole

(suitable for many soccer tables after
 adaptation holes and templates during
 installation)
 (compatibile con numerosi calcetti previo
 adattamento fori e sagome in fase
 d'installazione)



GLASS ON TOP KIT FOR STORM AND STORM F3 KIT VETRO SOPRA PER STORM E STORM F3	
14635	Standard
14355	For revolving goal keeper / Per portiere girevole



GLASS ON TOP KIT FOR STORM AND STORM F2 KIT VETRO SOPRA PER STORM E STORM F2	
14695	Standard
14695PG	For revolving goal keeper / Per portiere girevole

**NEW PRODUCT
 NOVITA'**

KIT LIGHT COBRA

Art. 14631

KIT LUCE COBRA



SUITABLE FOR ALL SOCCER TABLE MODELS
EASY ASSEMBLY (SUPPLIED WITH CABLE AND FIXING SCREWS)
STOVE-ENAMELLED IRON STRUCTURE
LOW POWER CONSUMPTION NEON TUBE
PLASTIC PROTECTIVE GRID

ADATTABILE A TUTTI I MODELLI DI CALCETTI
FACILE MONTAGGIO (COMPLETO DI CAVO E VITI PER FISSAGGIO)
STRUTTURA IN FERRO VERNICIATA A FORNO
LUCE AL NEON A BASSO CONSUMO
GRIGLIA DI PROTEZIONE IN PLASTICA



CE
MADE IN ITALY

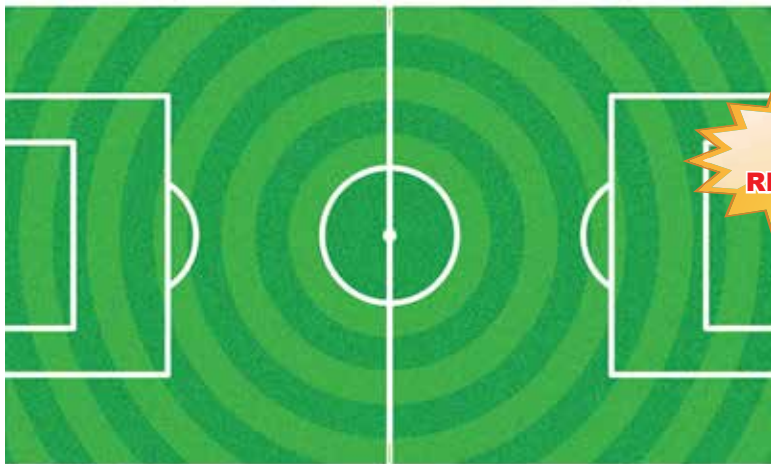

**UV
RESISTANT**



Paper sheet mod. "World Arena" (plastic coated, UV resistant) Foglio calcetto "World Arena" (plastificato, resistente ai raggi UV)	
6290	114x69,5 cm standard (Anonymous / anonimo)

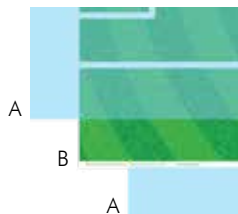

A) plastic transparent / plastica trasparente
B) print UV resistant / stampa resistente ai raggi UV

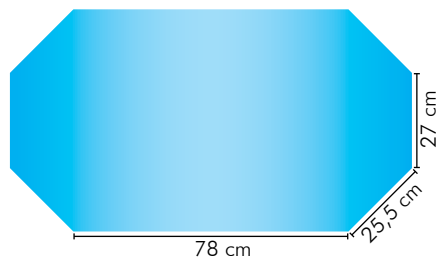

85 cm (revolving goal keeper/ portiere girevole)



85 cm (revolving goal keeper/ portiere girevole)

Tempered glass for soccer tables. Vetro temperato per calcetti.	
20030	Clear. 114x63x h.0,5 cm Trasparente. 114x63x h.0,5 cm
20030L	Clear for revolving goal keeper soccertable. 121x63x h.0,5 cm Trasparente per calcetto portiere girevole. 121x63x h.0,5 cm
20031	Sanded glass 114x63x h.0,5 cm Vetro sabbato. 114x63x h.0,5 cm
20031L	Sanded glass for revolving goal keeper soccertable. 121x63x h.0,5 cm Vetro sabbato per calcetto portiere girevole. 121x63x h.0,5 cm

Tempered and silk-screen printed glass for soccertables Storm. Vetro temperato e serigrafato per calcetti Storm.	
20100	Silk screen printed glass for outdoor soccer table. 114x63x h.0,5 cm Vetro serigrafato per calcetto da esterno. 114x63x h.0,5 cm
20101	Silk screen printed glass for outdoor revolving goalkeeper soccertable. 121x63x h.0,5 cm Vetro serigrafato per calcetto da esterno portiere girevole. 121x63x h.0,5 cm



Art. 2215 - Ø16 mm
Passing bearing "A90"
Boccola "A90" passante



Art. 2213 - Ø16 mm
Telescopic bearing "A91"
Boccola "A91" rientrante



Art. 2212 - Ø16 mm
Passing bearing "Fast", 20/30
Boccola "Fast" passante, 20/30
Art. 2212-19 Ø16 mm
Passing bearing "Fast", 19/25
Boccola "Fast" passante, 19/25



Art. 2121 - Ø10 mm
Telescopic bearing "Laser"
Boccola "Laser" rientrante



Art. 2294 - Ø16 mm
Passing bearing "Evo"
Boccola "Evo" passante



Art. 2293 - Ø16 mm
Telescopic bearing "Evo"
Boccola "Evo" rientrante



Art. 300190 - Ø16 mm
Passing bearing "Laser"
Boccola "Laser" passante

Art. 2088-18 - Ø18 mm
Passing bearing "Laser"
Boccola "Laser" passante



Art. 2121 - Ø10 mm
Telescopic bearing "Laser"
Boccola "Laser" rientrante



Art. 2088 - Ø16 mm
Passing bearing "Slide"
Boccola "Slide" a sfera passante



Art. 2121 - Ø10 mm
Telescopic bearing "Laser"
Boccola "Laser" rientrante

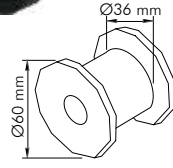
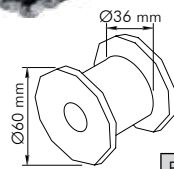
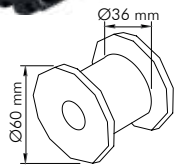

**BEARINGS FOR SOCCER TABLE WITH TELESCOPIC RODS
BOCCOLE PER CALCETTO ASTE RIENTRANTI**

Bearings' models / Modelli boccole	Pieces / Pezzi
A90 passing + A91 telescopic A90 passante + A91 rientrante	8 + 8 pcs / pz
Fast passing + Laser telescopic Fast passante + Laser rientrante	8 + 8 pcs / pz
Evo passing + Evo telescopic Evo passante + Evo rientrante	8 + 8 pcs / pz
Laser passing + Laser telescopic Laser passante + Laser rientrante	8 + 8 pcs / pz
Slide passing + Laser telescopic Slide passante + Laser rientrante	8 + 8 pcs / pz

**BEARINGS FOR SOCCER TABLE WITH PASSING RODS
BOCCOLE PER CALCETTO ASTE PASSANTI**

Bearings' models / Modelli boccole	Pieces / Pezzi
A90 passing / A90 passante	16 pcs / pz
Fast passing / Fast passante	16 pcs / pz
Evo passing / Evo passante	16 pcs / pz
Laser passing / Laser passante	16 pcs / pz
Slide passing / Slide passante	16 pcs / pz



Art. 2072
Bush for balls introduction Ø50 mm
Bocchettone per introduzione palline Ø50 mm



Art. 3518
Bush for balls introduction eco Ø50 mm
Bocchettone per introduzione palline eco Ø50 mm



Art. 18060 - Ø16 mm
Stopper for passing rods
Puntale per aste passanti



Art. 2217
Release bearing for telescopic rods
Boccola a scatto per aste rientranti



Art. 2216
Big bearing for telescopic rods
Boccola grande per aste rientranti



Art. 300009
Seeger ring for telescopic rods
Ghiera per aste rientranti



Art. 18070 - Ø10 mm
Stopper for telescopic rods
Gommino per aste rientranti



Art. 14554
Black PVC washer for soccer table leg
Ranella pvc nero per gamba calcetto



Art. 14636
Wheels for Klipper (kit)
Kit ruote per calcetto Klipper



Art. 14072
Ashtray black universal for soccer table
Portacenere universale nero per calcetto



Art. 18233 - Int.135x65 mm - Ext.160x80x25 mm
Black pvc frame for balls holder
Cornice pvc nero per raccogli palline



Art. 14681 - Ext.220x80x25 mm
Garniture for soccer table goal ext.
Guarnizione per porta calcetto

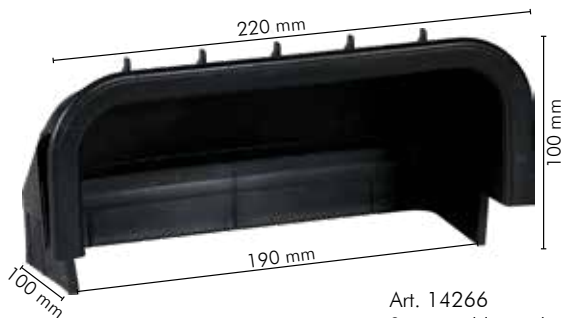

Art. 14266
Soccer table goal
Porta calcetto



Art. 14101
Recess bottle tray
Portabottiglie ad incasso



Art. 1119 - Ext.240x153x73 mm
Goal soccetable Superdue
Porta per calcetto Superdue



Art. 14802
Bottle tray for soccer table
Porta bottiglie per calcetto



Art. 2285 - 768x145x28 mm
Cuff black anonymous
Paramano nero anonimo



Art. 11035PVC
Ring stopping pvc with screw
6MA Ø16 mm
Anello d'arresto pvc nero con vite
6MA Ø16 mm

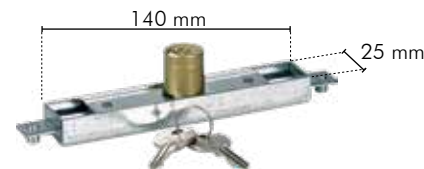

Art. 300185
Lock for soccer table
Serratura per calcetto



Art. 3347
Lock for Klipper soccer table
Serratura per calcetto Klipper



Rubber buffer for rods,
washer included
Molla in gomma per aste,
completa di ranella

h.	SHORE 30		SHORE 50	
	Ø 16	Ø 18	Ø 16	Ø 18
16 mm	11151	11151-18	11219	11219-18
18 mm	11152	-	11216	-
24 mm	11153	-	11220	-
29 mm	11154	-	11221	-

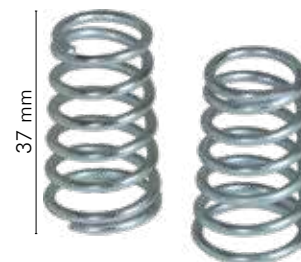

Art. 11036 - Ø16 mm
Conic spring for rods
Molla conica per aste

Art. 11147 - Ø18 mm
Conic spring for rods
Molla conica per aste



Art. 11036C - Ø16 mm
Short conic shaped spring for "Klipper"
Molla conica corta per "Klipper"



Art. 11032C - Ø10 mm
Short conic spring
Molla conica corta



Art. 14693
Knob for coin shute G07
Pomello per gettoniera G07



Art. L317
Screw for leg mod. Stadium family
Vite per gamba Stadium family

10MA x 50 mm



Art. 2163
Mounting plate for coin shute
(screws included)
Squadretta per gettoniera (viti incluse)

100 mm

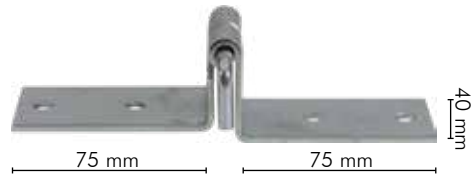

Art. 300265
Hinge for soccertables mod. Longoni
Cerniera per calcetto serie Longoni

40 mm

75 mm 75 mm

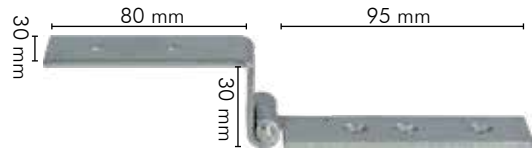

Art. 300524
Hinge for soccertables mod. Storm
Cerniera per calcetto Storm

80 mm 95 mm

30 mm 30 mm



Art. 300533
Hinge for soccertables mod. Stadium
Cerniera per calcetto Stadium

30 mm

40 mm 90 mm

Art. 15000
Black/white key-ring ball goal
Bilia portachiavi goal bianca/nera

Art. 15001
Black/yellow key-ring ball goal
Bilia portachiavi goal gialla/nera

Art. 15002
Black/red key-ring ball goal
Bilia portachiavi goal rossa/nera

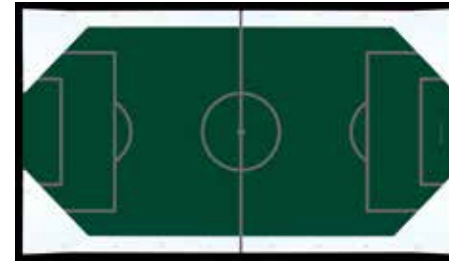

Art. 1030 - set 4 pcs./pz.
Plastic fixing glass angles, high (40mm)
Angolari fermavetro in plastica, alti (40mm)

Art. 1200
Corners for soccer table with wooden playfield - set
Angolari serie senza battuta (per piano legno)

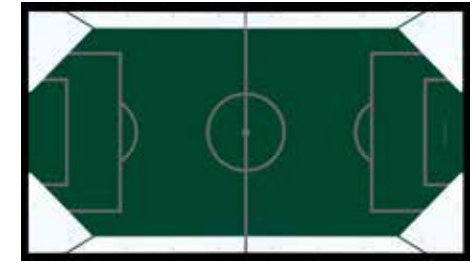
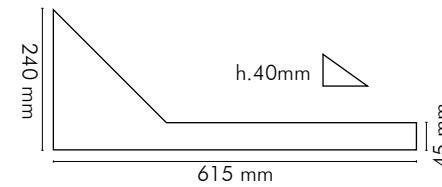

Art. 1031 - set 8 pcs./pz.
Plastic fixing glass angles, low (20mm)
Angolari fermavetro in plastica, bassi (20mm)

Art. 1032 - set 8 pcs./pz.
Plastic fixing glass angles, low (20mm), green
Angolari fermavetro in plastica, bassi (20mm), verdi

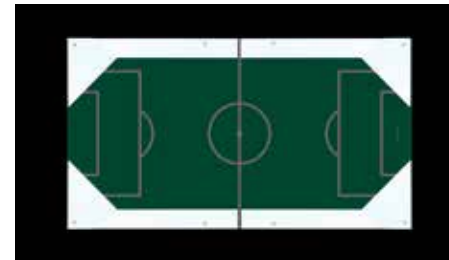
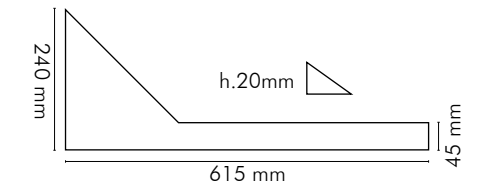

Art. 10444 - set 4 pcs./pz.
Plastic fixing glass angles, baby serie
Angolari fermavetro in plastica, serie baby

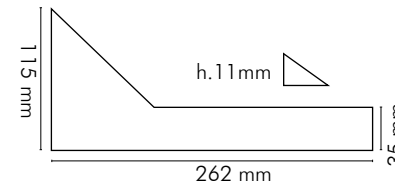



Art. 14289
Rubber spare part for adjustable feet
Gomma di ricambio per piedino regolabile snodato



Art. 300186 - Ø80 mm h.50 mm
Round rubber foot for soccer table leg
Piedino gomma cilindrico per gamba calcetto



Art. 14552 - 90x90x30 mm
Pvc squared foot for soccer table leg with thread for adjustable foot
Piedino quadrato pvc nero per gamba calcetto con filetto per piedino regolabile



Art. 300499 - 80x80x50 mm
Squared rubber foot for soccer table leg
Piedino gomma quadrato per gamba calcetto

Art. 300532 - 90x90x50 mm
Squared rubber foot for soccer table leg
Piedino gomma quadrato per gamba calcetto



Art. 18401 - Ø100 mm h.18 mm
Rubber adjustable foot.
Piedino regolabile in gomma.



Art. 18409 - Ø53 mm h.23 mm
Rubber self-threaded foot for Storm F1
Piedino in gomma autofilettante per calcetto Storm F1



Art. 14141
Specific lubricant for soccer table rods. No stain after its use, high speed game guaranteed for hours, longer rods lifetime. Perfect for indoor soccer tables wonderful for outdoor soccer tables.

Art. 14141
Lubrificante specifico per aste per calcetto. Non sporca, garantisce ore di gioco veloce e allunga la vita delle tue aste. Ottimo per i calcetti da interno, eccezionale per quelli da esterno.



Art. 11005 - Ø16 mm
Plastic/wooden handle.
Manopola plastica/legno.



Art. 11150 - Ø16 mm
"Super sport" plastic/rubber handle.
Manopola "Super sport", plastica/gomma.



Art. 11163 - Ø16 mm
Rubber/plastic handle "Evo", gray.
Manopola "Evo" in gomma/plastica, grigia.



Art. 11166 - Ø16 mm
Black handle Evo.
Manopola nera Evo.



Art. 11233 - Ø int. 16 mm
Art. 11234 - Ø int. 18 mm
Handle "Evo Pulsar" black thermoplastic rubber TGA-85
Manopola "Evo Pulsar" in gomma nera termoplastica TGA-85



Art. 14406 - Ø16 mm
Rubber handle "Pro".
Manopola "Pro" gomma.



Art. 11024 - Ø16 mm
Art. 11148 - Ø18 mm
Rubber handle.
Manopola in gomma nera.



Art. 11001 - Ø16 mm
Plastic black handle.
Manopola plastica nera.



Art. 11075 - Ø16 mm
Yellow handle.
Manopola gialla.



Art. 11003 - Ø16 mm
Wooden handle.
Manopola legno.

Art. 18257

Handgrip for rods, 2pcs set
*colours can change without any previous notice
Tubolare per manopola, set 2pz
*variazioni di colori possibili



PASSING RODS Ø 16mm, ASSIST FOOT
ASTE PASSANTI Ø 16mm, PIEDINO ASSIST

Art. 1045 - Ø 16mm
 Passing rods blue/red **set**.

Set completo aste passanti.

Art. 1064 - Ø 16mm
 Passing rods blue/red **set**,
 for outdoor soccertables.

*Set completo aste passanti
 doppia cromatura per modelli
 da esterno.*



DOUBLE CHROMED

Art. 1199 - Ø 16mm
 Passing rods blue/red **set**,
 for outdoor soccertables.

*Set completo aste passanti
 tripla cromatura per modelli
 da esterno.*

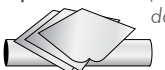

TRIPLE CHROMED

Code no. for single rod / *Articolo singola asta*

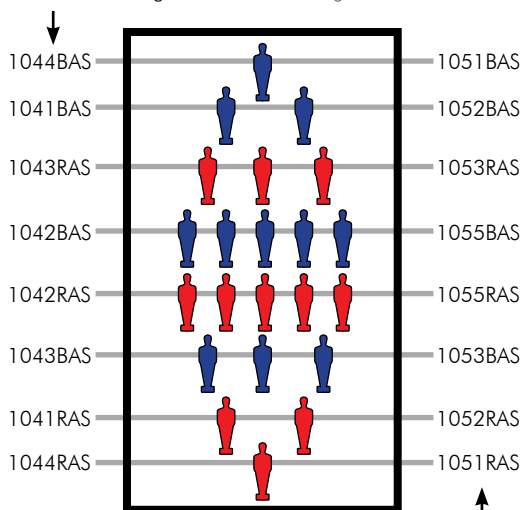

Code no. for single rod, **double chromed**
Articolo singola asta doppia cromatura

*(without handles and springs)
 (senza manopole e molle)*

PASSING RODS Ø 16mm, CLASSIC FOOT
ASTE PASSANTI Ø 16mm, PIEDINO CLASSIC

Code no. for single rod
Articolo singola asta

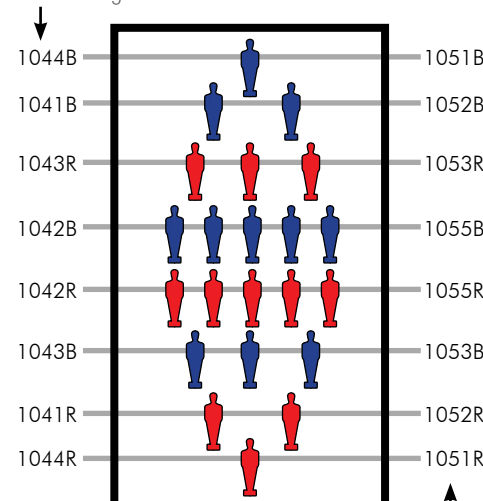

Code no. for single rod, **double chromed**
Articolo singola asta doppia cromatura

Art. 1045CL - Ø 16mm
 Passing rods blue/red **set**.

Set completo aste passanti.

Art. 1064CL - Ø 16mm
 Passing rods blue/red **set**,
 for outdoor soccertables.

*Set completo aste passanti
 doppia cromatura per modelli
 da esterno.*



DOUBLE CHROMED

*(without handles and springs)
 (senza manopole e molle)*

TELESCOPIC RODS Ø 16mm, ASSIST FOOT
ASTE TELESCOPICHE Ø 16mm, PIEDINO ASSIST

Art. 1057 - Ø 16mm
 Telescopic rods blue/red **set**.

Set completo aste telescopiche.

*(without handles and springs)
 (senza manopole e molle)*

Code no. for single rod
Articolo singola asta

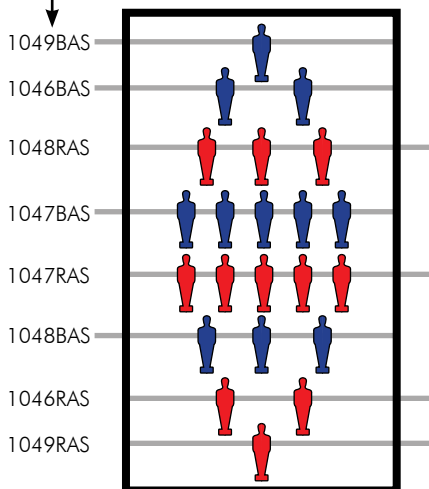

TELESCOPIC RODS Ø 16mm, CLASSIC FOOT
ASTE TELESCOPICHE Ø 16mm, PIEDINO CLASSIC

Art. 1057CL - Ø 16mm
 Telescopic rods

Set completo aste telescopiche.

Art. 1116CL - Ø 16mm
 Telescopic rods blue/red **set**,
 for outdoor soccertables.

*Set completo aste telescopiche
 doppia cromatura per modelli
 da esterno.*

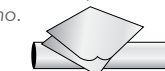

DOUBLE CHROMED

*(without handles and springs)
 (senza manopole e molle)*



PASSING RODS Ø 18mm, ASSIST FOOT
ASTE PASSANTI Ø 18mm, PIEDINO ASSIST

Art. 1115 - Ø 18mm
 Passing rods blue/red **set**.
 Set completo aste passanti.

(without handles and springs)
 (senza manopole e molle)

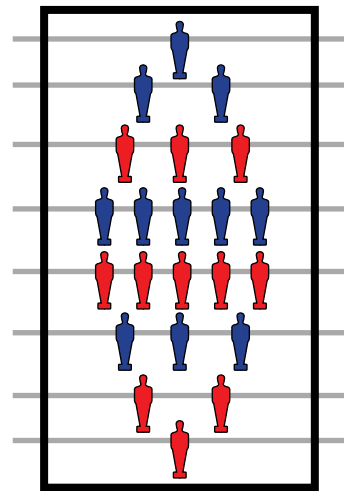

TELESCOPIC RODS Ø 18mm, ASSIST FOOT
ASTE TELESCOPICHE Ø 18mm, PIEDINO ASSIST

Art. 1096 - Ø 18mm
 Telescopic rods blue/red **set**.
 Set completo aste telescopiche.

(without handles and springs)
 (senza manopole e molle)

Code no. for single rod
 Articolo singola asta

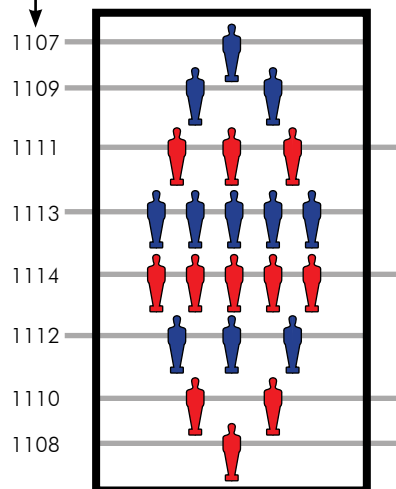

TELESCOPIC RODS Ø 16mm, FOOT CLASSIC
FOR KLIPPER & SUPERDUE
ASTE TELESCOPICHE Ø 16mm, PIEDINO CLASSIC
PER KLIPPER & SUPERDUE

Art. 1093 - Ø 16mm
 Telescopic rods blue/red **set**
 (4 telescopic rods + 4 telescopic internal rods).

Set completo aste telescopiche rosso/blu
 (4 aste telescopiche + 4 aste telescopiche interne).

(without handles and springs)
 (senza manopole e molle)

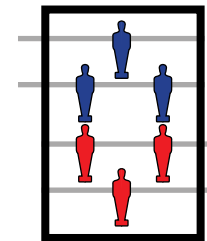

Art. 1094 - Ø 16mm
Complete kit telescopic rods for Klipper
 Includes:
 set telescopic rods (art. 1093)
 4 passing bearings A/90 (art. 2215)
 4 telescopic bearings A/91 (art. 2213)
 8 spring conic Ø 16mm (art. 11160)
 1 scoremarker cubes red (art.17004)
 1 scoremarker cubes blue (art.17009)
 10 white balls (art. 14497)
 4 handles for rods yellow (art. 11075)

Kit completo aste telescopiche per calcetto Klipper
 Contiene:
 set completo aste telescopiche (art. 1093)
 4 boccole A/90 passanti (art. 2215)
 4 boccole A/91 rientranti (art. 2213)
 8 molle coniche Ø 16mm (art. 11160)
 1 segnapunti a cubetti rosso (art. 17004)
 1 segnapunti a cubetti blu (art. 17009)
 10 palline bianche (art. 14497)
 4 manopole gialle (art. 11075)



Art. 300184
 Shooting round scoreboarder red
 Segnapunti rotondo a scatto rosso



Art. 300183
 Shooting round scoreboarder blue
 Segnapunti rotondo a scatto blu



Art. 17004
 Scoremarker abacus red
 Segnapunti a cubetti rosso



Art. 17002
 Scoremarker abacus red
 Segnapunti a pallottoliere rosso



Art. 17009
 Scoremarker abacus blue
 Segnapunti a cubetti blu



Art. 17006
 Scoremarker abacus blue
 Segnapunti a pallottoliere blu

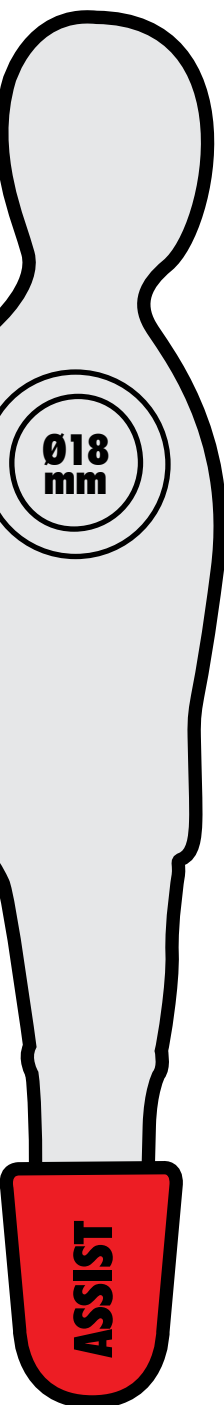

**FULL KIT MADE OF 8 PASSING RODS, CLASSIC FOOT,
KIT COMPLETO DI 8 ASTE PASSANTI, PIEDINO CLASSIC**



Ø 16 mm		
Kit art. 1070CL	Kit art. 1082CL	Kit art. 1086CL
nr. 1 passing rods blue/red set <i>set aste passanti</i> (art.1045CL)	nr. 1 passing rods blue/red set <i>set aste passanti</i> (art.1045CL)	nr. 1 passing rods blue/red set <i>set aste passanti</i> (art.1045CL)
nr. 1 scoremarker red <i>segnapunti rosso</i> (art.17004)	nr. 1 scoremarker red <i>segnapunti rosso</i> (art.17004)	nr. 1 scoremarker red <i>segnapunti rosso</i> (art.17004)
nr. 1 scoremarker blue <i>segnapunti blu</i> (art.17009)	nr. 1 scoremarker blue <i>segnapunti blu</i> (art.17009)	nr. 1 scoremarker blue <i>segnapunti blu</i> (art.17009)
nr. 8 handle for rods <i>manopola plastica</i> (art.11001)	nr. 8 handle for rods <i>manopola plastica</i> (art.11001)	nr. 8 handle for rods <i>manopola plastica</i> (art.11001)
nr. 10 balls white soccer <i>palline bianche</i> (art. 14497)	nr. 10 balls white soccer <i>palline bianche</i> (art. 14497)	nr. 10 balls white soccer <i>palline bianche</i> (art. 14497)
nr. 16 bearings Passing Evo <i>boccole Evo passanti</i> (art.2294)	nr. 16 bearings Passing Laser <i>boccole Laser passanti</i> (art.300190)	nr. 16 bearings Passing Slide <i>boccole Slide passanti</i> (art.2088)
nr. 16 springs conic for rods <i>molle coniche</i> (art.11036)	nr. 16 springs conic for rods <i>molle coniche</i> (art.11036)	nr. 16 springs conic for rods <i>molle coniche</i> (art.11036)
nr. 8 black stopper <i>tappi di sicurezza</i> (art. 18060)	nr. 8 black stopper <i>tappi di sicurezza</i> (art. 18060)	nr. 8 black stopper <i>tappi di sicurezza</i> (art. 18060)

**FULL KIT MADE OF 8 TELESCOPIC RODS, CLASSIC FOOT,
KIT COMPLETO DI 8 ASTE TELESCOPICHE, PIEDINO CLASSIC**



Ø 16 mm		
Kit art. 10701CL	Kit art. 10821CL	Kit art. 10861CL
nr. 1 telescopic rods blue/red set <i>set aste telescopiche</i> (art.1057CL)	nr. 1 telescopic rods blue/red set <i>set aste telescopiche</i> (art.1057CL)	nr. 1 telescopic rods blue/red set <i>set aste telescopiche</i> (art.1057CL)
nr. 1 scoremarker red <i>segnapunti rosso</i> (art.17004)	nr. 1 scoremarker red <i>segnapunti rosso</i> (art.17004)	nr. 1 scoremarker red <i>segnapunti rosso</i> (art.17004)
nr. 1 scoremarker blue <i>segnapunti blu</i> (art.17009)	nr. 1 scoremarker blue <i>segnapunti blu</i> (art.17009)	nr. 1 scoremarker blue <i>segnapunti blu</i> (art.17009)
nr. 8 handle for rods <i>manopola plastica</i> (art.11001)	nr. 8 handle for rods <i>manopola plastica</i> (art.11001)	nr. 8 handle for rods <i>manopola plastica</i> (art.11001)
nr. 10 balls white soccer <i>palline bianche</i> (art. 14497)	nr. 10 balls white soccer <i>palline bianche</i> (art. 14497)	nr. 10 balls white soccer <i>palline bianche</i> (art. 14497)
nr. 8 bearings Passing Evo <i>boccole Evo passanti</i> (art.2294) + nr. 8 bearings Telescopic Evo <i>boccole Evo rientranti</i> (art.2293)	nr. 8 bearings Passing Laser <i>boccole Laser passanti</i> (art.300190) + nr. 8 bearings Telescopic Laser <i>boccole Laser rientranti</i> (art.2121)	nr. 8 bearings Passing Slide <i>boccole Slide passanti</i> (art.2088) + nr. 8 bearings Telescopic Laser <i>boccole Laser rientranti</i> (art.2121)
nr. 16 springs conic for rods <i>molle coniche</i> (art.11036)	nr. 16 springs conic for rods <i>molle coniche</i> (art.11036)	nr. 16 springs conic for rods <i>molle coniche</i> (art.11036)
nr. 8 telescopic internal rods <i>aste telescopiche interne</i> (art. 1097)	nr. 8 telescopic internal rods <i>aste telescopiche interne</i> (art. 1097)	nr. 8 telescopic internal rods <i>aste telescopiche interne</i> (art. 1097)

**FULL KIT MADE OF 8 PASSING RODS, ASSIST FOOT,
KIT COMPLETO DI 8 ASTE PASSANTI, PIEDINO ASSIST**











Ø 16 mm		Ø 18 mm
Kit art. 1070	Kit art. 1086	112266
nr. 1 passing rods blue/red set <i>set aste passanti</i> (art.1045)	nr. 1 passing rods blue/red set <i>set aste passanti</i> (art.1045)	nr. 1 passing rods blue/red set <i>set aste passanti</i> (art.1115)
nr. 1 scoremarker red <i>segnapunti rosso</i> (art.17004)	nr. 1 scoremarker red <i>segnapunti rosso</i> (art.17004)	nr. 1 scoremarker red <i>segnapunti rosso</i> (art.17004)
nr. 1 scoremarker blue <i>segnapunti blu</i> (art.17009)	nr. 1 scoremarker blue <i>segnapunti blu</i> (art.17009)	nr. 1 scoremarker blue <i>segnapunti blu</i> (art.17009)
nr. 8 handle for rods <i>manopola plastica</i> (art.11001)	nr. 8 handle for rods <i>manopola plastica</i> (art.11001)	nr. 8 handle for rods <i>manopola plastica</i> (art.11148)
nr. 10 balls white soccer <i>palline bianche</i> (art. 14497)	nr. 10 balls white soccer <i>palline bianche</i> (art. 14497)	nr. 10 balls white soccer <i>palline bianche</i> (art. 14497)
nr. 16 bearings Passing Evo <i>boccole Evo passanti</i> (art.2294)	nr. 16 bearings Passing Slide <i>boccole Slide passanti</i> (art.2088)	nr. 16 bearings Passing Laser <i>boccole Laser passanti</i> (art.2088-18)
nr. 16 springs conic for rods <i>molle coniche</i> (art.11036)	nr. 16 springs conic for rods <i>molle coniche</i> (art.11036)	nr. 16 springs conic for rods <i>molle coniche</i> (art.11147)
nr. 8 black stopper <i>tappi di sicurezza</i> (art. 18060)	nr. 8 black stopper <i>tappi di sicurezza</i> (art. 18060)	nr. 8 black stopper <i>tappi di sicurezza</i> (art. 18060)

**FULL KIT MADE OF 8 TELESCOPIC RODS, ASSIST FOOT,
KIT COMPLETO DI 8 ASTE TELESCOPICHE, PIEDINO ASSIST**



Ø 16 mm			Ø 18 mm
Kit art. 10701	Kit art. 10821	Kit art. 10861	Kit art. 10951
nr. 1 passing rods blue/ red set <i>set aste passanti</i> (art.1057)	nr. 1 passing rods blue/ red set <i>set aste passanti</i> (art.1057)	nr. 1 passing rods blue/ red set <i>set aste passanti</i> (art.1057)	nr. 1 passing rods blue/ red set <i>set aste passanti</i> (art.1096)
nr. 1 scoremarker red <i>segnapunti rosso</i> (art.17004)	nr. 1 scoremarker red <i>segnapunti rosso</i> (art.17004)	nr. 1 scoremarker red <i>segnapunti rosso</i> (art.17004)	nr. 1 scoremarker red <i>segnapunti rosso</i> (art.17004)
nr. 1 scoremarker red <i>segnapunti rosso</i> (art.17004)	nr. 1 scoremarker red <i>segnapunti rosso</i> (art.17004)	nr. 1 scoremarker red <i>segnapunti rosso</i> (art.17004)	nr. 1 scoremarker red <i>segnapunti rosso</i> (art.17004)
nr. 8 handle for rods <i>manopola plastica</i> (art.11001)	nr. 8 handle for rods <i>manopola plastica</i> (art.11001)	nr. 8 handle for rods <i>manopola plastica</i> (art.11001)	nr. 8 handle for rods <i>manopola plastica</i> (art.11148)
nr. 10 balls white soccer <i>palline bianche</i> (art. 14497)	nr. 10 balls white soccer <i>palline bianche</i> (art. 14497)	nr. 10 balls white soccer <i>palline bianche</i> (art. 14497)	nr. 10 balls white soccer <i>palline bianche</i> (art. 14497)
nr. 8 bearings Passing Evo <i>Evo passanti</i> (art.2294) + nr. 8 <i>boccole</i> Telescopic Evo <i>Evo rientranti</i> (art.2293)	nr. 8 bearings Passing Laser <i>Laser passanti</i> (art.300190) + nr. 8 <i>boccole</i> Telescopic Laser <i>Laser rientranti</i> (art.2121)	nr. 8 bearings Passing Slide <i>Slide passanti</i> (art.2088) + nr. 8 <i>boccole</i> Telescopic Laser <i>Laser rientranti</i> (art.2121)	nr. 8 bearings Passing Slide <i>Slide passanti</i> (art.2088-18) + nr. 8 <i>boccole</i> Telescopic Laser <i>Laser rientranti</i> (art.2121)
nr. 16 springs conic for rods <i>molle coniche</i> (art.11036)	nr. 16 springs conic for rods <i>molle coniche</i> (art.11036)	nr. 16 springs conic for rods <i>molle coniche</i> (art.11036)	nr. 16 springs conic for rods <i>molle coniche</i> (art.11147)
nr. 8 telescopic internal rods <i>aste telescopiche interne</i> (art. 1097)	nr. 8 telescopic internal rods <i>aste telescopiche interne</i> (art. 1097)	nr. 8 telescopic internal rods <i>aste telescopiche interne</i> (art. 1097)	nr. 8 telescopic internal rods <i>aste telescopiche interne</i> (art. 1097)

FULL KIT MADE OF 8 DOUBLE AND TRIPLE CHROMED RODS
KIT COMPLETO DI 8 ASTE DOPPIA E TRIPLA CROMATURA

Ø 16 mm			
PASSING / PASSANTI	PASSING / PASSANTI	PASSING / PASSANTI	TELESCOPIC TELESCOPICHE
 DOUBLE CHROMED 	 DOUBLE CHROMED 	 TRIPLE CHROMED 	 DOUBLE CHROMED 
Kit art. 1076CL Double chromed rods Aste con <i>doppia cromatura</i>	Kit art. 1076 Double chromed rods Aste con <i>doppia cromatura</i>	Kit art. 1120 Triple chromed rods Aste con <i>trippla cromatura</i>	Kit art. 1121CL Double chromed rods Aste con <i>doppia cromatura</i>
nr. 1 passing rods set set aste passanti (art.1064CL)	nr. 1 passing rods set set aste passanti (art.1064)	nr. 1 passing rods set set aste passanti (art.1199)	nr. 1 telescopic rods set set aste telescopiche (art.1116CL)
nr. 1 scoremarker red segnapunti rosso (art.17004)	nr. 1 scoremarker red segnapunti rosso (art.17004)	nr. 1 scoremarker red segnapunti rosso (art.17004)	nr. 1 scoremarker red segnapunti rosso (art.17004)
nr. 1 scoremarker blue segnapunti blu (art.17009)	nr. 1 scoremarker blue segnapunti blu (art.17009)	nr. 1 scoremarker blue segnapunti blu (art.17009)	nr. 1 scoremarker blue segnapunti blu (art.17009)
nr. 8 handle for rods manopola plastica (art.11001)	nr. 8 handle for rods manopola plastica (art.11001)	nr. 8 handle for rods manopola plastica (art.11001)	nr. 8 handle for rods manopola plastica (art.11001)
nr. 10 balls white soccer palline bianche (art. 14497)	nr. 10 balls white soccer palline bianche (art. 14497)	nr. 10 balls white soccer palline bianche (art. 14497)	nr. 10 balls white soccer palline bianche (art. 14497)
nr. 16 bearings Passing Evo boccole Evo passanti (art.2294)	nr. 16 bearings Passing Evo boccole Evo passanti (art.2294)	nr. 16 bearings Passing Evo boccole Evo passanti (art.2294)	nr. 8 bearings Passing Evo boccole Evo passanti (art.2294) + nr. 8 bearings Telescopic Evo boccole Evo rientranti (art.2293)
nr. 16 springs conic for rods molle coniche (art.11036)	nr. 16 springs conic for rods molle coniche (art.11036)	nr. 16 springs conic for rods molle coniche (art.11036)	nr. 16 springs conic for rods molle coniche (art.11036)
nr. 8 black stopper tappi di sicurezza (art. 18060)	nr. 8 black stopper tappi di sicurezza (art. 18060)	nr. 8 black stopper tappi di sicurezza (art. 18060)	nr. 8 black stopper tappi di sicurezza (art. 18060)

Art. 1051

Rod passing 2 players, without men Ø 16 mm

Asta passante terzino senza ometti Ø 16 mm

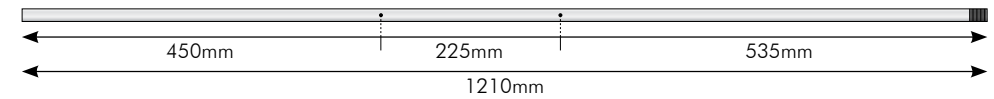

Art. 1054

Rod passing 5 players, without men Ø 16 mm

Asta passante attaccante senza ometti Ø 16 mm

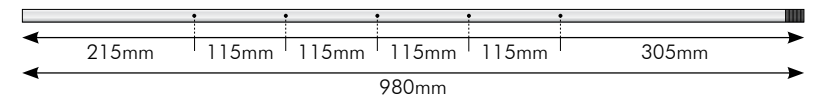

Art. 1052

Rod passing 3 players, without men Ø 16 mm

Asta passante mediano senza ometti Ø 16 mm

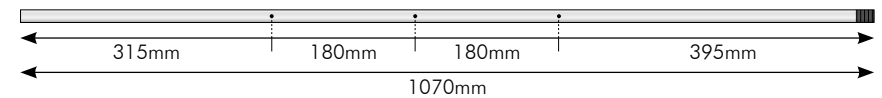

Art. 1053

Rod passing 1 player, without men Ø 16 mm

Asta passante portiere senza ometti Ø 16 mm

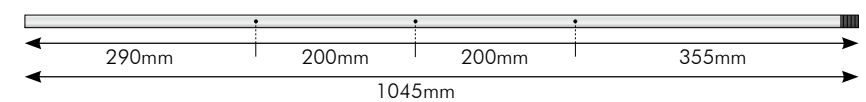

Art. 1050

Set rods passing without men Ø 16 mm (8pcs - 2 each type)

Set aste passanti senza ometti Ø 16 mm (8pz - 2 per tipo)

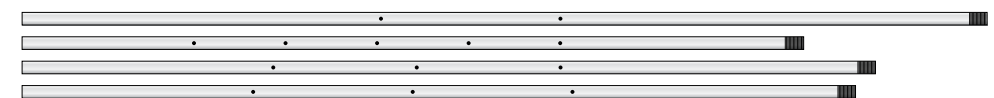

Art. 1055

Rod telescopic internal Ø 10 mm for telescopic rods

Astina telescopica interna Ø 10 mm per aste telescopiche

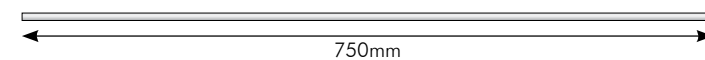

Art. 1097

Rod telescopic internal for Klipper e Superdue Ø 10 mm

Astina telescopica interna per Klipper e Superdue Ø 10 mm

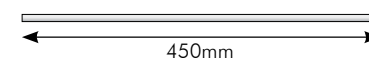

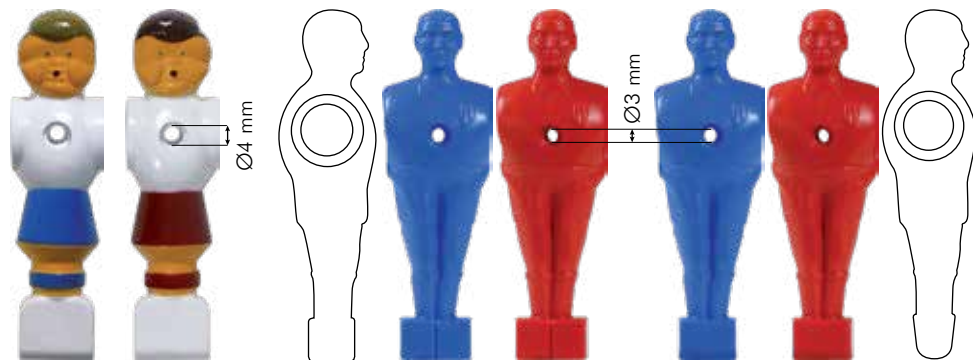

Art. 13008 - Ø16mm
"Eagle" plastic blue soccer man
Ometto "Eagle" plastica blu

Art. 13007 - Ø16mm
"Eagle" plastic red soccer man
Ometto "Eagle" plastica rosso

Art. 13001 - Ø16 mm
Blue soccer man, classic
Ometto blu, classic

Art. 13002 - Ø16 mm
Red soccer man, classic
Ometto rosso, classic

Art. 13112 - Ø16 mm
Blue soccer man, assist
Ometto blu, assist

Art. 13113 - Ø16 mm
Red soccer man, assist
Ometto rosso, assist

PROFESSIONAL BALLS / PALLINE PROFESSIONALI



Art. 18989 - set 3 pcs
"Bomber" red / rosse

Art. 18990 - set 3 pcs
"Bomber" orange / arancioni

Art. 18991 - set 3 pcs
"Bomber" white / bianche



Art. 14501 - set 10 pcs
Natural cork ball, 13 gr
Pallina sughero naturale, 13 gr



Art. 14502 - set 10 pcs
White cork ball, 13 gr
Pallina sughero bianca, 13 gr



Art. 14503 - set 10 pcs
Yellow cork ball, 13 gr
Pallina sughero gialla, 13 gr



Art. 14499 - set 10 pcs
Orange ball, 16 gr
Pallina arancio, 16 gr



Art. 14498 - set 10 pcs
Yellow ball, 16 gr
Pallina gialla, 16 gr



Art. 14634 - set 10 pcs
Nir Pro ball, 23 gr
Pallina Nir Pro, 23 gr



Art. 14497 - set 10 pcs
White ball, 16 gr
Pallina bianca, 16 gr



Art. 14505 - set 10 pcs
White/black ball, 17 gr
Pallina bianco/nera, 17 gr

Art. 14504 - set 10 pcs
Anti-bounce white ball, 16 gr
Pallina bianca anti-rimbalzo, 16 gr



Art. 11060
T-shirt black/blue set
Set maglie neroazzurro



Art. 11167
T-shirt red/black set
Set maglie rossonere



Art. 11168
T-shirt white/black set
Set maglie bianconere



Art. 11169
T-shirt white/blue set
Set maglie biancoazzurro



Art. 11178
T-shirt España set
Set maglie España



Art. 11179
T-shirt Portugal set
Set maglie Portugal



Art. 11180
T-shirt Nederland set
Set maglie Nederland



Art. 11181
T-shirt Brasil set
Set maglie Brasil



Art. 11170
T-shirt purple set
Set maglie viola



Art. 11171
T-shirt lightblue set
Set maglie azzurre



Art. 11172
T-shirt yellow/red set
Set maglie giallorosse



Art. 11174
T-shirt "granata" set
Set maglie granata



Art. 11182
T-shirt England set
Set maglie England



Art. 11183
T-shirt Croatia set
Set maglie Croatia



Art. 11184
T-shirt Italia set
Set maglie Italia



Art. 11185
T-shirt Deutschland set
Set maglie Deutschland



Art. 11175
T-shirt red/blue set
Set maglie rossoblu



Art. 11176
T-shirt "grifone" set
Set maglie grifone



Art. 11177
T-shirt pink/black set
Set maglie rosanero

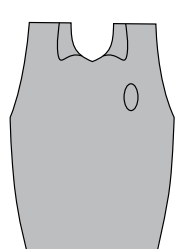

Art. 11173
T-shirt "custom" set
Set maglie "custom"



Art. 11186
T-shirt México set
Set maglie México



Art. 11187
T-shirt Sweden set
Set maglie Sweden



Art. 11188
T-shirt Argentina set
Set maglie Argentina



Art. 11189
T-shirt France set
Maglie France



T-shirt goal keeper
Maglie portiere

Set composed by:
- 10 t-shirts players
- 1 t-shirt goalkeeper
Set composto da:
- 10 maglie giocatori
- 1 maglia portiere

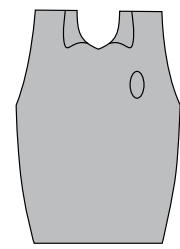

Art. 11173
T-shirt "custom" set
Set maglie "custom"



T-shirt goal keeper
Maglie portiere

Set composed by:
- 10 t-shirts players
- 1 t-shirt goalkeeper
Set composto da:
- 10 maglie giocatori
- 1 maglia portiere



Art. 12535
Lock for soccetable
Serratura calcetto



Art. 12536
Telescopic bearing
Boccola rientrante



Art. 12537
Slide bearing for passing rods
Boccola a sfera per asta passante

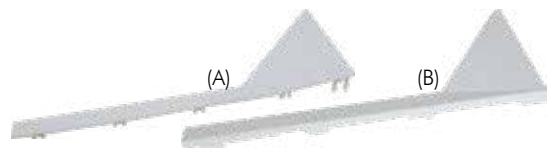

Art. 12540 - 4pcs / 4pz (A)
Plastic high fixing corners, h.40 mm
Angolari fermavetro alti in plastica, h.40 mm

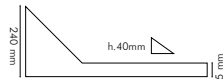

Art. 12541 - 4pcs / 4pz (B)
Plastic low fixing corners, h.20 mm
Angolari fermavetro bassi in plastica, h.20 mm

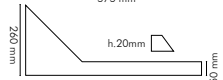

Art. 12541PG* - 4pcs / 4pz (B)
Plastic low fixing corners, h.20 mm
Angolari fermavetro bassi in plastica, h.20 mm

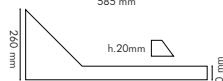

* For revolving goal keeper
Per portiere girevole



Art. 12539
Blue cubes score marker
Segnapunti a cubetti blu



Art. 12538
Red cubes score marker
Segnapunti a cubetti rosso

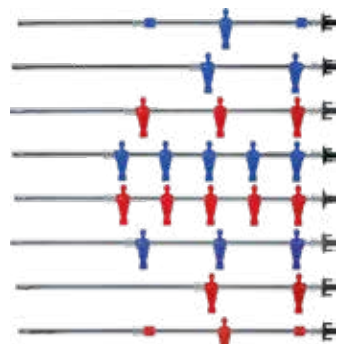

Art. 12544 - set
Telescopic rods with internal rods and bearings - indoor use
Aste telescopiche con astine interne e boccole - per interno

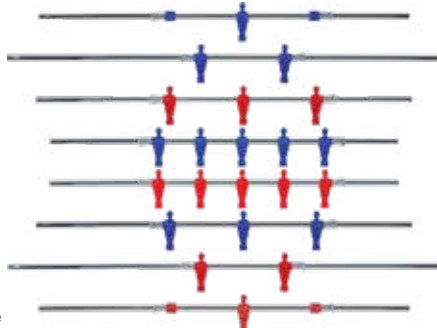

Art. 12542 - set
Passing rods - indoor use
Aste passanti - per interno

11141	Conic spring for passing rod Ø16 mm - 23 mm Molla conica per asta passante Ø16 mm - 23 mm
12545	Conic spring for passing rod Ø16 mm - 36 mm Molla conica per asta passante Ø16 mm - 36 mm
11143	Conic spring for telescopic rod Ø16 mm - 30 mm Molla tronca conica per asta rientrante Ø16 mm - 30 mm
11144	Conic spring for telescopic rod Ø10 mm - 30 mm Molla conica per asta rientrante Ø10 mm - 30 mm



G 07

Coin-shute G07, 115 x 135 mm
Gettoniera G07, 115 x 135 mm

Art. 14693
Knob for coin shute G-07
(it can be bought also separately)
Pomello per gettoniera G-07
(acquistabile anche separatamente)

Art. 300199G07
Spring for coinshute G07
Molla trazione per gettoniera G07



Art. 3335
Counter (not included - optional)
Contacolpi (non incluso - acquistabile separatamente)

Art.	
7038050EURO	0,50 EURO
70381EURO	1 EURO
70382EURO	2 EURO
7039	TOKENS "V"
70121FCH	1 CHF
70122FCH	2 CHF
701210KCEC	10 CZK
7039GETT4SC	4SCAL.7017

M48

Electromechanic plate coin-shute, 155 x 60 mm
 Gettoniera elettromeccanica piastra, 155 x 60 mm

Art.	
7013050EURO	0,50 EURO
70131EURO	1 EURO
70132EURO	2 EURO
7013	TOKENS



DIFFERENT TOKEN MASKS AVAILABLE
 SUITABLE FOR ELECTRONIC COIN-OP POOL

MASCHERINE INTERCAMBIABILI ADATTE PER
 POOL A GETTONIERA ELETTRONICA



G 10

Coin-shute G10, 88 x 120 x 30 mm
 Gettoniera G10, 88 x 120 x 30 mm

Art.	
7139	0,50 EURO
71391EURO	1 EURO
71392EURO	2 EURO
71391FCH	1 CHF
71392FCH	2 CHF

MR 89



Art. 3049
 Counter (included)
 Contacolpi (incluso)

Coin-shute MR89, 100 x 130 mm
 Gettoniera MR89, 100 x 130 mm

Art.	
7041050EURO	0,50 EURO
70411EURO	1 EURO
70412EURO	2 EURO
70411FCH	1 CHF
70412FCH	2 CHF
704110KCEC	10 CZK
70415KUNA	5 KUNA
7041	FOREIGN MON
7136	TOKENS PUSH
7050	TOKENS

Art. 14257
 Rack for MR89
 Cremagliera per MR89

Art. 14258
 Pawl for MR89
 Nottolino dentato per MR89



Art. 14256
 Shooting bar for MR89
 Asta a tiro per MR89

Art. 14267
 Front guide for rod for MR89
 Guida anteriore asta per MR89

Art. 300188
 SPRING for MR89
 Molla a trazione per MR89



Art. 300396
 Screw+nut+washer for MR89
 Vite+dado+ranella per MR89



Coin-shute for vending machine,
127 x 110 mm
Gettoniera per distributore,
127 x 110 mm

Art.	
17739	1 EURO
17739050EURO	0,50 EURO
177392EURO	2 EURO
177391FCH	1 CHF
177392FCH	2 CHF



Art. 15928
Electronic kit for soccer table
Kit elettronico calcetto

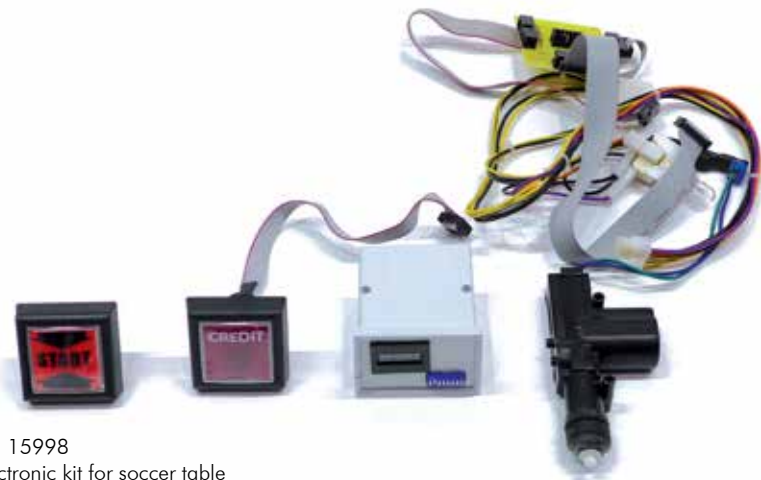

Art. 15998
Electronic kit for soccer table
Kit elettronico calcetto eco

TOKENS AND PLATES/GETTONI E MASCHERINE

TOKEN / GETTONE	STD	MR89	G-07
<p>art. 7219</p>	<p>art. 7313</p>	<p>art. 7314</p>	<p>art. 7315</p>
<p>art. 7017</p>	<p>art. 7316</p>	<p>art. 7317</p>	<p>art. 7318</p>
<p>art. 7142G</p>	<p>art. 7319</p>	<p>art. 7320</p>	<p>art. 7321</p>
<p>art. 7044</p>	<p>art. 7323</p>	<p>art. 7324</p>	<p>art. 7325</p>
<p>art. 7142F</p>	<p>art. 7326</p>	<p>art. 7327</p>	<p>art. 7328</p>



Table tennis & accessories
Ping pong & accessori

PING PONG BANDITO OUTDOOR

Art. W415101



Outdoor tennis table, Bandito line.

Made in germany, highly resistant to bad weather (humidity and hot temperature resistant) and with original approved size for tournaments.

The panel is made of melanine resin, schock resistant and its thickness is 4 mm. It is also strongly connected to a metallic structure with a thickness of 36 mm and anti-rust painted.

It can be closed completely or half folded, closure system very practical. Once folded, the table has a width of 55 cm about.

Equipped with side support in order to contain balls and bats (not included in the price).

The table is tuv approved and follows the rules en 14468-1.

Suitable also for internal use and for schools or youth centers.

Wheels can offer an easy transport.

Included in the price : a net set and assembly instructions.

Size of the box : 163x145x12 cm

Weight : kg. 59 about



Ping pong da tavolo Bandito outdoor.

Made in germany, altamente resistente alle intemperie e con dimensioni originali da torneo (274x152,5x76 cm). Il pannello in resina melaminica e' resistente agli urti e ha uno spessore di 4 mm. E' saldamente collegato a una struttura metallica di 36 mm di spessore.

Il piano e' resistente all'umidita' ma anche alle alte temperature. La struttura e' verniciata a polvere antiruggine.

Il tavolo puo' essere piegato interamente o a meta' (per il giocare da soli) e possiede un meccanismo di aggancio molto pratico. Dotato di supporti laterali per contenere le palline e le racchette.

Il ping pong e' tuv approvato e segue la norma EN 14468-1.

Il tavolo puo' essere usato anche all'interno ed e' adatto per scuole o centri giovanili.

Una volta piegato, il tavolo ha una larghezza di circa 55 cm. Le ruote permettono un facile trasporto.

Sono compresi un set di rete e istruzioni di montaggio (palline e racchette non comprese nel prezzo ma acquistabili separatamente).

Dimensione della scatola: 163x145x12 cm

Peso: kg. 59

PING PONG BANDITO JUNIOR FUN

Art. W414001



Junior Fun is the indoor tennis table suitable for kids and adults.

Easy to be installed, strong resistant, space-saving capacity and adjustable feet in order to assemble and move the table easily and faster.

The top quality net is suitable also for tournament and has a practical quick release system.

Size: 135 x 75 x 76 cm - 1 pc. plate.

Net weight: 17 kg - Gross weight : 21 kg

Size of the packing: 138 x 79 x 5 cm

Junior fun e' il tavolo da ping pong adatto sia per bambini che per adulti ad uso interno.

Facile da installare, resistente agli urti, dotato di capacita' salva spazio e di piedini regolabili per rendere piu' facile l'assemblaggio e lo spostamento.

Grazie al piedistallo posizionato nella parte superiore, il tavolo necessita solo di essere aperto.

Rete adatta anche per tornei e dotata di un sistema di sgancio rapido.

Misure: 135 x 75 x 76 cm - Piano 1 pz.

Peso netto: 17 kg - Peso lordo: 21 kg

Misura confezione: 138 x 79 x 5 cm

SPARES-PARTS/ACCESSORI



Art. W412501
Net set ia universal for ping pong
Retina ia universale per ping pong

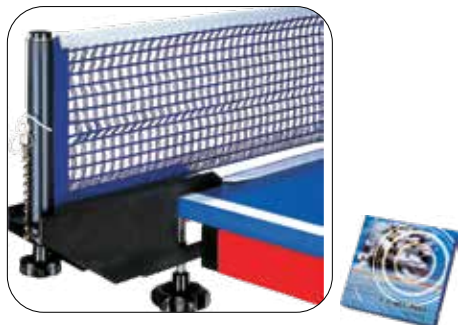

Art. 15939
ITTF post and cotton net set, ruler,
net size 15x183 cm
*Set tendirete ITTF e retina in cotone.
Retina 15x183 cm*



Art. 15941
Plastic post and nylon net set, ruler.
Net size 15x178 cm
*Set tendirete in plastica e retina in nylon.
Retina 15x178 cm*



Art. 15940
Clamp type post and cotton net set, ruler.
Net size 15x175 cm
*Set tendirete a scatto e retina in cotone.
Retina 15x175 cm*



Art. W413001
Cover for ping pong table Bandito
Size: 150x160x55-80 cm
*Coperta per ping pong Bandito
Dimensione: 150x160x55-80 cm*

HOBBY SERIES/SERIE HOBBY

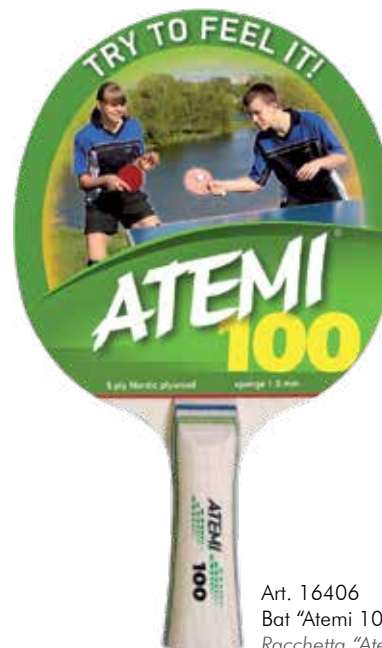

Art. 16406
Bat "Atemi 100"
Racchetta "Atemi 100"



Art. 16405
Bat "Atemi 200"
Racchetta "Atemi 200"



Art. 16404
Bat "Atemi 300"
Racchetta "Atemi 300"



Art. 16419
Set "Hobby"
Set "Hobby"

PRO SERIES/SERIE PRO



Art. 16412
Bat "Atemi 400"
Racchetta "Atemi 400"



Art. 16411
Bat "Atemi 500"
Racchetta "Atemi 500"



Art. 16408
Bat "Atemi 800"
Racchetta "Atemi 800"



Art. 16407
Bat "Atemi 900"
Racchetta "Atemi 900"



Art. 16410
Bat "Atemi 600"
Racchetta "Atemi 600"



Art. 16409
Bat "Atemi 700"
Racchetta "Atemi 700"

Art. 16402
Bat "Atemi 2000"
Racchetta "Atemi 2000"



Art. 16403
Bat "Atemi 1000"
Racchetta "Atemi 1000"



Art. 16415 - set 6 pcs/pz
Balls for table tennis AteMI - 1star white
Palline ping pong AteMI - 1star bianche

Art. 16417 - set 6 pcs/pz
Balls for table tennis AteMI - 3stars white
Palline ping pong AteMI - 3stars bianche

Art. 16414 - set 6 pcs/pz
Balls for table tennis AteMI - 1star orange
Palline ping pong AteMI - 1star arancio

Art. 16418 - set 6 pcs/pz
Balls for table tennis AteMI - 3stars orange
Palline ping pong AteMI - 3stars arancio



Art. 16413
Cover for ping pont bats AteMI
Custodia porta racchette AteMI



Art. 15985
Bat "Evo S-II" red
Racchetta "Evo S-II" rossa



Art. 15986
Bat Evo S-II blue
Racchetta Evo S-II blu



Art. 15947
Bat "Smash"
Racchetta "Smash"



Art. 15948
Bat Evo "Hurricane"
Racchetta "Hurricane"



Art. 15950
Bat "Attack"
Racchetta "Attack"



Art. W411501
Balls for table tennis *Star (box 6 pcs)
*Palline ping pong *Star (scat. 6 pz)*



Art. W411503
Balls for table tennis *Star (box 100 pcs)
*Palline ping pong *Star (scat. 100 pz)*



Air hockey & accessories
Air hockey & accessori

AIR HOCKEY "GOLD" 8ft (224 x 112 cm) - Indoor

Art. 17581G



Art. 17828
Plexiglass® divider
(it can be bought also separately)
Divisorio in Plexiglass®
(acquistabile anche separatamente)

- Playingfield made of stainless steel
- Electronic coin selector COMESTERO RM5
- 4 plastic handles and 6 pucks included in the table
- UV lamp included in the standard version
- Plexiglass® divider included
- Flash diodes on the playingfield included
- Package: (legs incl.): 245x130x50 cm
- Weight: 230 kg
- Playing field: 224x112 cm
- Height: 90 cm
- **CE** certificated

- Campo gioco in acciaio inossidabile
- Selettore di moneta elettronico Comestero RM5
- 4 battitori in plastica e 6 dischetti di dotazione
- Lampada UV nella versione std.
- Completo di separatore in Plexiglass®
- Include diodi sul piano gioco,
- Misure imballo: (gambe incluse) 245x130x50 cm
- Peso: 230 kg
- Campo gioco: 224x112 cm
- Altezza: 90 cm
- Certificato **CE**

AIR HOCKEY "SMALL BABY" - Indoor

Art. 17826

art. 17828
Plexiglass® divider
(it can be bought also
separately)

Divisorio in Plexiglass®
(acquistabile anche
separatamente)

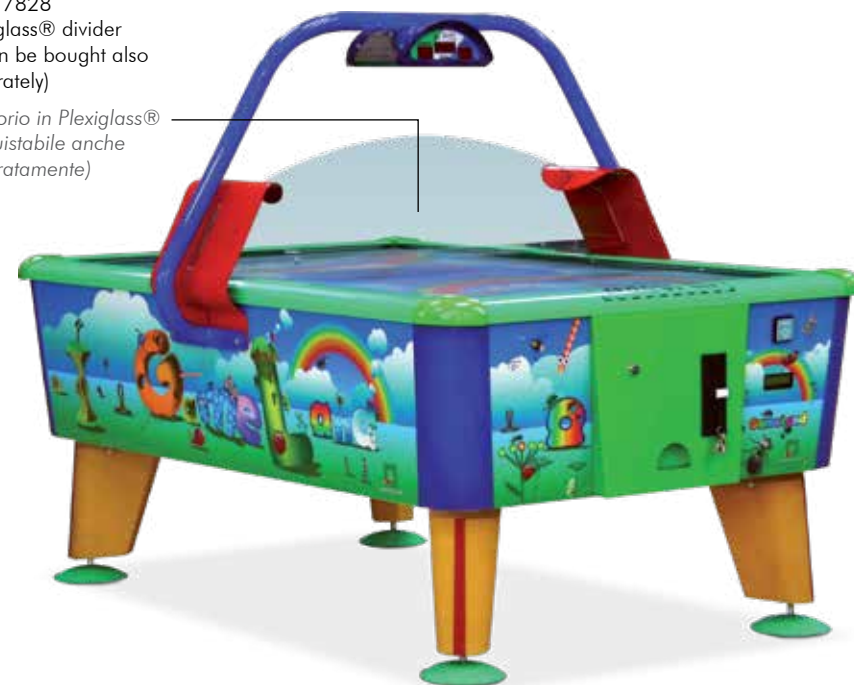

- External sizes: 163x107x h.67 cm (without lamps)
- Playingfield made of Plexiglass®. Sizes: 145x89x0,8 cm
- Accessories: 4 plastic handles and 6 pucks included
- Electronic coin shute
- Plexiglass® divider included
- Magic legs system
- Material of the body: laminated plywood
- Packaging sizes: 168x115x h.45 cm
- Weight: 150 kg
- **CE** certificated

- Dimensioni esterne: 163x107x h.67 cm (senza lampada)
- Campo gioco in Plexiglass®. Misure: 145x89x0,8 cm
- Dotazione: 4 battitori in plastica e 6 dischetti
- Gettoniera elettronica
- Separatore Plexiglass® incluso
- Sistema magic legs
- Materiale cassone: Laminato compensato
- Dimensione dell'imballo: 168x115x h.45 cm
- Peso: 150 kg
- Certificato **CE**

AIR HOCKEY "ARCTIC" 8ft (224 x 112 cm) - Outdoor

Art. 3524



Outdoor

- Suitable for outdoor. 100% waterproof.
- Polycarbonate perforated playfield.
- Comestero RM5 or NRI electronic coin acceptor.
- Polycarbonate barrier on both sides and in the center of the playfield.
- LED lighting system in the playfield and in the legs.
- Digital score display for each player.
- Standard power supply 230V/50Hz.
- Power consumption 60W (demo mode), 390W (game mode).
- Polycarbonate top frame around the playfield with a lighting system.
- External sizes: 240x130 cm
- Package: (legs included.): 243x138x54 cm
- Weight: 220 kg
- Playingfield: 224x112 cm
- Height: 90 cm
- 4 plastic handles and 6 pucks included
- Certificated **CE**

- Adatto per esterno. 100% impermeabile.
- Campo gioco perforato in polycarbonato.
- Gettoniera elettronica Comestero RM5 o NRI.
- Barriera in polycarbonato su entrambi i lati e al centro del campo gioco.
- sistema di illuminazione a LED nel campo gioco e nelle gambe.
- Display punteggio digitale per ogni giocatore.
- alimentazione standard 230V/50Hz.
- consumo energetico 60W (modalità demo), 390W (modalità di gioco).
- Cornice del campo gioco in polycarbonato con un sistema di illuminazione.
- Misure esterne: 240x130 cm
- Misure imballo: (gambe incluse) 243x138x54 cm
- Peso: 220 kg
- Campo gioco: 224x112 cm
- Altezza: 90 cm
- 4 battitori in plastica e 6 dischetti di dotazione
- Certificato **CE**

AIR HOCKEY "SKATE" 8ft (224 x 112 cm) - Outdoor

Art. 3400



Outdoor

- Suitable for outdoor. 100% waterproof.
- Polycarbonate perforated playfield.
- Comestero RM5 or NRI electronic coin acceptor.
- Polycarbonate barrier on both sides and in the center of the playfield.
- LED lighting system in the playfield and in the legs.
- Digital score display for each player.
- Standard power supply 230V/50Hz.
- Power consumption 60W (demo mode), 390W (game mode).
- Polycarbonate top frame around the playfield with a lighting system.
- Package: (legs included.): 243x138x54 cm
- Weight: 220 kg
- Playingfield: 224x112 cm
- Height: 90 cm
- 4 plastic handles and 6 pucks included
- Certificated **CE**

- Adatto per esterno. 100% impermeabile.
- Campo gioco perforato in polycarbonato.
- Gettoniera elettronica Comestero RM5 o NRI.
- Barriera in polycarbonato su entrambi i lati e al centro del campo gioco.
- sistema di illuminazione a LED nel campo gioco e nelle gambe.
- Display punteggio digitale per ogni giocatore.
- alimentazione standard 230V/50Hz.
- consumo energetico 60W (modalità demo), 390W (modalità di gioco).
- Cornice del campo gioco in polycarbonato con un sistema di illuminazione.
- Misure imballo: (gambe incluse) 242x138x190 cm
- Peso: 240 kg
- Campo gioco: 224x112 cm
- Altezza: 80 cm
- 4 battitori in plastica e 6 dischetti di dotazione
- Certificato **CE**

AIR HOCKEY SPARES / RICAMBI PER AIR HOCKEY



Art. 17950
Motor for metal door
Motore per porta metallo



Art. 17779
Electromagnet
Elettromagnete



Art. 19179
Motor for air hockey Gold
Motore per air hockey Gold



Art. 17698
Motherboard for air hockey Fire
Scheda madre per air hockey Fire



Art. 17698G
Mother board 2.0 for air hockey Gold
Scheda madre 2.0 per air hockey Gold



Art. 17699
Coin shute
Gettoniera



Art. 17831
Power supply
Alimentatore



Art. 3396
"Start" button
Pulsante "start"



Art. 3395
"Credit" display button
Pulsante "credit" con display



Art. 17954
Microswitch
Microswitch



Art. 17951G
Optical sensor 2.0 for air hockey 8' gold + conn lan
Sensore ottico 2.0 per air hockey gold + conn. lan

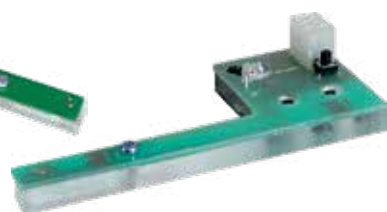

Art. 17951
Optical sensor standard for air hockey 8
Sensore ottico standard per air hockey 8'

AIR HOCKEY "ALABAMA"

Art. 3392



HOME
DESIGNED
-
USO
ABITAZIONE

- External sizes: 212,5x106,5x79,5 cm
- Playingfield sizes: 197,5x91 cm
- Playing surface: 3 mm MDF
- Side panel: 17 mm MDF, 18 cm wide
- Top panel: 7,5 cm
- Top rail corners: rounded ABS
- Legs: 12 mm MDF
- Leg panels: 9 mm MDF
- Leg levellers: Ø13 cm, chrome plated
- Scorers: manual slide scorer
- Pucks: 2 pcs, Ø6,5 cm
- Handles: 2 pcs, Ø9,5 cm
- Airflow system: UL,TUV/GS recognized high output electric motor
- Power: supplied with 110V and 240V motors (2pcs)
- Packaging sizes: 220x116x35 cm
- Weight: 75 kg

- Dimensioni esterne: 212,5x106,5x79,5 cm
- Dimensioni di gioco: 197,5x91 cm
- Superficie di gioco: 3 mm MDF
- Sponda laterale: 17 mm MDF, larga 18 cm
- Sponda di testa: 7,5 cm
- Angolari di testa: ABS arrotondato
- Gambe: 12 mm MDF
- Pannelli orizzontali: 9 mm MDF
- Piedini regolabili: Ø13 cm, cromati
- Segnapunti: segnapunti scorrevole manuale
- Dischi: 2 pcs, Ø6,5 cm
- Manopole: 2 pcs, Ø9,5 cm
- Flusso d'aria: UL, TUV/GS motore ad alto rendimento
- Energia: fornita con motori 110V e 240V (2 pcs)
- Misure imballo: 220x116x35 cm
- Peso: 75 kg



Art. 3509
Corner for air hockey Alabama
Angolare per air hockey Alabama

AIR HOCKEY "MONTANA"

Art. 3515



**HOME
DESIGNED
-
USO
ABITAZIONE**

- External sizes: 203x107x79 cm
- Playingfield size: 197x91 cm
- Playingfield thickness: 4,5 mm MDF with white PCV laminate
- Upper cushions: 104x12 mm, MDF with PVC laminate
- Side rails: 129,60x12 mm MDF with black PVC laminate
- Frame: 12 mm MDF
- Legs: 13x5x12 mm in MDF with black PVC laminate
- Electrical and manual score marker
- Motor: 2 pezzi DC
- Adapter: 1 pezzo, 12V
- Included: 2 red pucks, 2 handles
- Packaging sizes: 208x112x20 cm
- Net weight: 49 kg
- Lord weight: 55 kg
- Volume: 0.50 M3 circa
- CE approved

- Dimensioni esterne: 203x107x79 cm
- Dimensioni campo gioco: 197x91 cm
- Spessore superficie di gioco: 4,5 mm MDF con laminato PVC bianco
- Sponde superiori: 104x12 mm, MDF con laminato in PVC
- Fasce laterali: 129,60x12 mm MDF con laminato in PVC nero
- Telaio: 12 mm MDF
- Gambe: 13x5x12 mm in MDF con laminato in PVC nero
- Segnapunti: elettronico e manuale
- Motore: 2 pezzi DC
- Adattatore: 1 pezzo, 12V
- Dotazione: 2 dischetti rossi; 2 manopole.
- Misure imballo: 208x112x20 cm
- Peso: 49 kg
- Peso lordo: 55 kg
- Volume: 0.50 M3 circa
- Certificato CE

AIR HOCKEY "TEXAS 5"

Art. 3532



**HOME
DESIGNED
-
USO
ABITAZIONE**

5' Air Hockey table, studied for family use only (not professional one) and suitable for players of all ages.
Black PVC legs and corners. Body made of MDF

Features:

- External sizes: 152.5x76x80 cm
- Playingfield size: 150x75.50 cm
- Head and side rails: in MDF and black PVC
- Wooden legs with matt black paint with MDF panel covered with black PVC, folding, with adjustable feet
- Scoreboard: basic electronic.
- 220 V motor
- Equipment: 4 handles, 4 felts, 4 pucks
- Package sizes: 160x83x15 cm
- Weight: 26 kg with packaging - 20 kg table only
- CE certificate

Tavolo air hockey con dimensioni ridotte rispetto a quelle ad uso professionale, per uso familiare pensato per i giocatori di ogni età.
Gambe e angolari in PVC nero e sponde in MDF

Caratteristiche:

- Dimensioni esterne: 152,5X76x80 cm
- Dimensioni campo gioco: 150x75,50 cm
- Sponde di testa e laterali: MDF e PVC nero
- Gambe in legno con verniciatura nero opaca unite da un pannello in MDF rivestito in PVC nero, pieghevoli, con piedini regolabili
- Segnapunti: elettronico basilare.
- Motore 220V
- Dotazione: 4 manopole; 4 feltrini; 4 dischetti
- Misure imballo: 160x83x15cm
- Peso: 26kg con imballo - 20kg solo tavolo
- Certificato CE



Art. 17804
Handle for air hockey 8' Ø12 cm
(felt included) - mixed colours
*Manopola air hockey 8' Ø12 cm
(completo di feltrino) - colori assortiti*



Art. 6013
Handle for air hockey Ø9,5 cm
Manopola air hockey Ø9,5 cm



Art. 300462
Handle for air hockey 8' Ø12 cm
Manopola air hockey 8' Ø12 cm



Art. 6017
Air hockey - felt Ø9,3 cm
*Feltrino per manopola
Air hockey Ø9,3 cm*



Art. 17829
Air hockey - felt Ø8,7 cm
*Feltrino per manopola
Air hockey Ø8,7 cm*



Art. 300465
Air hockey - felt Ø9,5 cm
*Feltrino per manopola
Air hockey Ø9,5 cm*



Art. 17701
Puck Ø7 cm for air hockey
23 gr - h.7 mm (mixed colours)
*Dischetto air hockey Ø7 cm
23 gr - h.7 mm (colori assortiti)*



Art. 6015
Puck Ø8,2 cm for air hockey
30 gr - h.7 mm
*Dischetto air hockey Ø8,2 cm
30 gr - h.7 mm*

Art. 6016
Puck Ø6,3 cm for air hockey
11,5 gr - h.5 mm
*Dischetto air hockey Ø6,3 cm
11,5 gr - h.5 mm*



Juke box

Juke box DENVER (BIG)



 **Bluetooth®**

Art. 5091

- Vinyl Jukebox

- MP3 function
- AM/FM radio function
- USB/SD function
- Bluetooth function (it can work with your ipod/iphone), located on the side. Aux function (with switch on/off)
- 7 color changing led lights system
- Wooden cabinet
- Multi functional remote control
- Size: (h)105 x (w)57 x (d)30 cm
- Precise sound quality
- Woofer, mid-range and tweeters
- Clean, well defined, high fidelity sound
- Power: 2x20W

PACKING:

- Export carton (triple corrugated)
 - Dimension: 67x40x115 cm = 0.3082 cbm
 - Gross weight: 25,3 kg
- APPROVAL: CE (EMC+LVD) FOR EU

- Jukebox con lettore vinile

- Funzione MP3
- Radio AM/FM
- Funzione USB/SD
- Funzione bluetooth (funziona con il tuo ipod/iphone). Funzione aux (con interruttore on/off)
- Luci a led, 7 colori
- Mobile in legno
- Telecomando multifunzionale
- Misure: (h)105 x (w)57 x (d)30 cm
- Qualità del suono precisa
- Woofer, mid-range e tweeters
- Suono pulito, ben definito, accurato
- Potenza: 2x20W

IMBALLAGGIO:

- Cartone esterno (tripla onda)
- Dimensioni: 67x40x115cm = 0.3082 cbm
- Peso lordo: 25,3 kg

OMOLOGAZIONE: CE (EMC+LVD) FOR EU

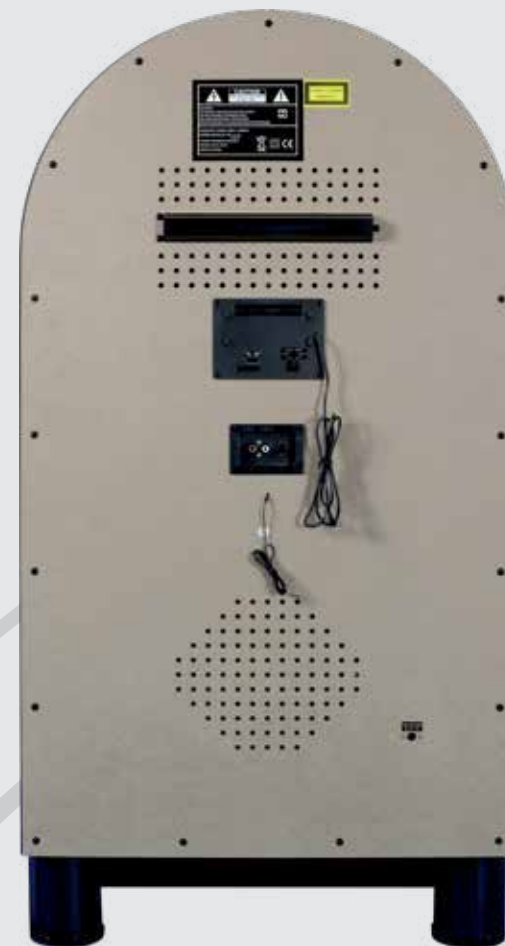

Juke box DENVER

(BIG)

Bluetooth®

Art. 5090

- Jukebox station with cd player
- MP3 function
- AM/FM radio function
- USB/SD function
- **Bluetooth function** (it can work with your ipod/iphone), located on the side. Aux fuction (with switch on/off)
- 7 color changing led lights system
- Wooden cabinet
- Multi functional remote control
- Size: (h)105 x (w)57 x (d)30 cm
- Precise sound quality
- Woofer, mid-range and tweeters
- Clean, well defined, high fidelity sound
- Power: 2x40W

PACKING:

- Export carton (triple corrugated)
- Dimension: 66 x 38,5 x 111 cm = 0.283 cbm
- Gross weight: 29 kg
- APPROVAL: CE (EMC+LVD) FOR EU



- Jukebox con lettore cd
- Funzione MP3
- Radio AM/FM
- Funzione USB/SD
- **Funzione bluetooth** (funziona con il tuo ipod/iphone). Funzione aux (con interruttore on/off)
- Luci a led, 7 colori
- Mobile in legno
- Telecomando multifunzionale
- Misure: (h)105 x (w)57 x (d)30 cm
- Qualità del suono precisa
- Woofer, mid-range e tweeters
- Suono pulito, ben definito, accurato
- Potenza: 2x40W

IMBALLAGGIO:

- Cartone esterno (tripla onda)
- Dimensioni: 66 x 38,5 x 111 cm = 0.283 cbm
- Peso lordo: 29 kg

OMOLOGAZIONE: CE (EMC+LVD) FOR EU



Juke box DENVER

(BIG)

USB/SD + IPOD

Art. 5089

- Jukebox station with professional cd player (sanyo)
- 7 colours changing led lights system
- Wooden cabinet
- FM radio function
- Multi functional remote control
- Size: (h)105 x (w)57 x (d)30 cm
- Precise sound quality
- Woofer, mid-range and tweeters
- Clean, well defined, high fidelity sound
- Power: 2x30W

PACKING:

- Export carton (triple corrugated)
 - Dimension: 66 x 38,5 x 111cm = 0.283 cbm
 - Gross weight: 29 kg
- APPROVAL: CE (EMC+LVD) FOR EU



- Jukebox con lettore cd professionale (sanyo)
- Luci a led, 7 colori
- Mobile in legno
- Radio FM
- Telecomando multifunzionale
- Misure: (h)105 x (w)57 x (d)30 cm
- Qualità del suono precisa
- Woofer, mid-range e tweeters
- Suono pulito, ben definito, accurato
- Potenza: 2x30W

IMBALLAGGIO:

- Dimensioni: 66 x 38,5 x 111cm = 0.283 cbm
 - Peso lordo: 29 kg
- OMOLOGAZIONE: CE (EMC+LVD) FOR EU



Juke box NEW ORLEANS

(SMALL)



**USB/SD
VERSION**



**IPOD
VERSION**



Art.5083 - USB / SD / AUX FUNCTION

Art.5084 - I-pod function and multi functional remote control

- Cd player
- AM - FM radio
- 7 colour changing led light system (with possibility to choose the colour)
- Wooden cabinet
- Power output: 2x7,5 W
- Sizes: 26x38x16,5 cm
- Volume: 0,035 m3
- Weight: 5 Kg

CE (EMC + LVD)
ETL/UL/FDA PER USA

Art.5083 - Ingresso USB / SD / AUX FUNCTION

Art.5084 - Ingresso I-pod e telecomando multifunzione

- Lettore CD
- Radio AM - FM
- Luci a LED 7 colori con possibilità di scelta del colore
- Mobile in legno
- Potenza stereo: 2x7,5 W
- Misure: 26x38x16,5 cm
- Ingombro: 0,035 m3
- Peso: 5 Kg

CE (EMC + LVD)
ETL/UL/FDA PER USA

Juke box **KANSAS** (MEDIUM)

**IPOD
VERSION**



Art. 5085

- Sanyo cd player
- I-pod function
- AM - FM radio
- 7 colour changing led light system (with possibility to choose the colour)
- Digital display
- Wooden cabinet
- Video equalizer
- Power output: 2 x 7,5 W
- Sizes 32 x 50, 5 x 25 cm
- Volume: 0,0408 m3
- Weight: 9 Kg
- Functional remote control

CE (EMC + LVD) FOR EU
ETL/UL/FDA FOR USA

Art. 5085

- Lettore CD Sanyo
- Attacco I-pod
- Radio AM - FM
- Luci a LED 7 colori con possibilità di scelta del colore
- Display digitale
- Mobile in legno
- Equalizzatore video
- Potenza stereo: 2 x 7,5 W
- Misure 32 x 50, 5 x 25 cm
- Volume: 0,0408 m3
- Peso: 9 Kg
- Telecomando multifunzione

CE (EMC + LVD) FOR EU
ETL/UL/FDA FOR USA



**Darts & accessories
Dardi e accessori**

ELECTRONIC DARTS/DARDI ELETTRONICI



**LED NEW
VERSION**

Art. 17410
Automatic dartboard "Cyberdine"
- External size: 62 x 200 x 45 cm
- Weight: 65 kg
- V: 110 - 240
- W max: 120

Art. 17410
Dardo meccanico "Cyberdine"
- Misure esterne: 62 x 220 x 45 cm
- Peso netto: kg 65
- V: 110 - 240
- W max: 120



**BEST
PRICE**

Art. 17410W
Automatic dartboard "Cyberdine"
- External sizes: 65 x 225 x 40 cm
- Packaging sizes: 70 x 230 x 45 cm
- Net weight: kg 75
- Gross weight: kg 80

Art. 17410W
Dardo meccanico "Cyberdine"
- Misure esterne: 65 x 225 x 40 cm
- Misure imballaggio: 70 x 230 x 45 cm
- Peso netto: kg 75
- Peso lordo: kg 80

Art. 18273
Dart Radikal Idarts / Dardo Radikal Idarts

Radikal Darts® is a professional dart machine featuring digital cameras, laser distance measuring and sensors for an exhilarating experience.

With Radikal Darts® you can choose to play either OFF LINE or ON LINE in real time and watching your opponents on the advanced 19" TFT display, their throws and scores.

Radikal Darts® introduces a new and unique technology, the Remote Refereeing System®, patented in Europe, USA and Japan. This system allows remote validation of each game by a referee, making it possible to organize championships in which the players can play anytime, anywhere.

Technical features:

- 3 Cameras to record the board and the player
- Laser light to control and measure the throw distance
- Panoramic 21.5" TFT
- Player card reader
- Touch screen
- Software for Leagues, Championships and stats management

Dimensions:
620 x 659 x 2327 mm (WxDxH)

Radikal Darts® è un dardo professionale che racchiude fotocamere digitali, un misuratore della distanza a laser e sensori garantendo un'esperienza di gioco esaltante.

Con Radikal Darts® puoi scegliere di giocare OFF line oppure ON line in tempo reale e guardare i tuoi avversari sul display TFT 19", così come i loro tiri e i loro punteggi.

Radikal Darts® introduce una nuova ed unica tecnologia, il cosiddetto Remote Refereeing System®, brevettato in Europa, USA e Giappone. Questo sistema garantisce una convalida remota di ogni partita da parte di un arbitro, rendendo possibile organizzare tornei nei quali i giocatori possono essere in qualsiasi posto in qualsiasi momento.

Dati tecnici:

- 3 fotocamere per filmare il dardo ed il giocatore
- luce laser che controllare e misurare la distanza di tiro
- Schermo panoramico TFT 21,5"
- Lettore di carte da gioco
- Touch screen
- Software per gare e campionati

Dimensioni:
620 x 659 x 2327 mm (LxPxH)



Art. W17770
 Dartautomat E-Master (for wall)
 Dardo automatico E-Master (a muro)

Art. W811201
 Stand for E-master black
 Piedistallo per dardo E-master nero

The new dart E-Master by Karella, made in Europe. Coin op professional dart (until 4 players) of high quality. It is possible to mount it on the wall thanks to the hooks of wall-mounting. As an option, it is possible to order also the stand (art. W811201). It can be used with different purposes: commercial use, in schools, in recreational centers and also as furniture. Suitable also for professional tournaments and for intensive training.

Height: 97,5 cm
 Length: 62 cm
 Depth: 46,5 cm
 Weight: kg 45

Il nuovo bersaglio Karella E-Master made in Europe. Dardo professionale (fino a 4 giocatori) di ottima qualita' con gettoniera. Fornito con la possibilita' di aggancio a muro per un montaggio diretto. Come opzione si puo' ordinare anche il piedistallo (art. W811201) Puo' essere usato con diversi scopi: uso commerciale, nelle scuole, nei centri giovanili e anche come oggetto da arredamento. Adatto anche per tornei professionali e per l'allenamento intensivo.

Altezza: 97,5 cm
 Larghezza: 62 cm
 Profondità: 46,5 cm
 Peso: 45 kg



DARTS ACCESSORIES/ACCESSORI PER DARDI ELETTRICI



Art. 15500006
 Switch matrix Novomatic
 Switch matrix Novomatic



Art. 4492
 Switch matrix Cyberdine x4
 Switch matrix Cyberdine x4



Art. 4492-3
 Switch matrix Cyberdine x3
 Switch matrix Cyberdine x3

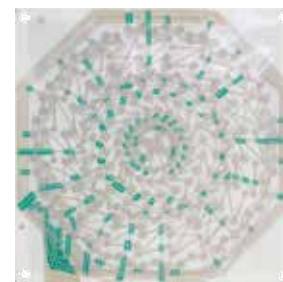

Art. 4552
 Switch matrix King Dart x4
 Switch matrix King Dart x4



Art. 4553
 Switch matrix King Dart x3
 Switch matrix King Dart x3



Art. 4489
 Empty spider Cyberdine
 Ragnatela vuota Cyberdine

Art. 86190002
 Empty spider Novomatic
 Ragnatela vuota Novomatic



Art. 4527
 Complete spider Cyberdine x4
 Ragnatela completa Cyberdine x4

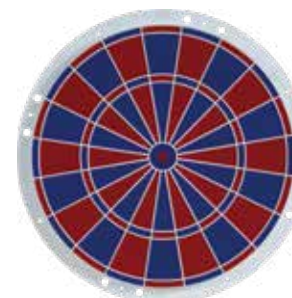

Art. 40450164
 Complete spider Novomatic
 Ragnatela completa Novomatic

Art. 4527-3
 Complete spider Cyberdine x3
 Ragnatela completa Cyberdine x3



Art. 4508
 Darthead complete Cyberdine x4
 Bersaglio completo Cyberdine x4

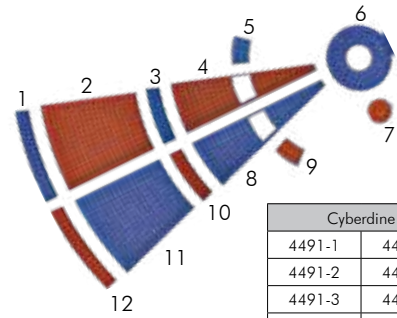

Dartboard sections
Settori per dardo

Cyberdine	
4491-1	4491-7
4491-2	4491-8
4491-3	4491-9
4491-4	4491-10
4491-5	4491-11
4491-6	4491-12



Art. F501
Plexiglass scores panel Cyberdine
Testata Plexiglass Cyberdine

Art. F816
Plexiglass scores panel Cyberdine with CPU
Testata Plexiglass Cyberdine con CPU

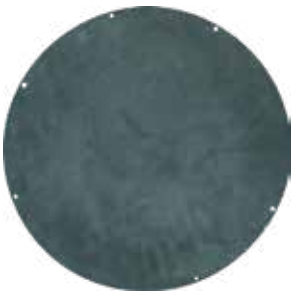

Art. 4543
Matrix rubber Cyberdine
Gomma per bersaglio Cyberdine

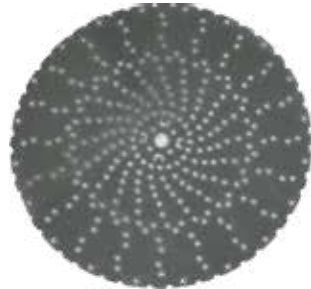

Art. F463
Sponge Cyberdine
Spugna Cyberdine



Art. F846
Cyberdine photoelectric cell
Fotocellula Cyberdine

Art. 40750002
Novomatic photoelectric cell
Fotocellula Novomatic



Art. F147
Motherboard Cyberdine
Scheda madre Cyberdine



Art. F148
Plexicover spotlight Cyberdine
Carter luci in metacrilato Cyberdine



Art. 17616
Power supply Cyberdine
Alimentatore Cyberdine



Art. N35500055
Novomatic sensor for missed dart sensor
Sensore tiro fuori Novomatic



Art. 12098
Lightbulb 12V 1,2W Cyberdine
Lampadina 12V 1,2W Cyberdine



Art. 12069
Lightbulb 12V
Lampadina taglio 12V



Art. F946
Lamp holder T5 Cyberdine
Portalampada T5 Cyberdine



Art. 17964
Foot Cyberdine
Piedino Cyberdine



Art. F437
Button 50 x 50 mm Cyberdine
(lamp and micro switch included)
Tasto 50 x 50 mm Cyberdine
(completo di lampada e micro switch)

Art. F438
Plexiglass for Cyberdine main door
Plexiglass per sportello Cyberdine



Art. A-32605
Adhesive throw line - 9 x 56 cm
Linea adesiva per distanza tiro - 9 x 56 cm



Art. F437
Button 50 x 50 mm Cyberdine
(lamp and micro switch included)
Tasto 50 x 50 mm Cyberdine
(completo di lampada e micro switch)



Art. 86190003
Dart web segment Novomatic/Cyberdine
Settore zero per Novomatic/Cyberdine



Art. D-70771
Dart- tip remover
Estrattore per punte

Art. F700
Sensor "out of target" Cyberdine
Sensore "bersaglio mancato" Cyberdine



Art. 16117
Tournament board, 16 players
Tabellone per gara, 16 giocatori





Art. O-7500
Electronic dartboard ULTRA soft tip
- 15.5 inch Soft Tip Worldwide Standard Size Target Area
- 29 Games & 90 Variations
- Simultaneous Game Play by up to 8 Players
- Large LCD Scoring Display with X/O "Cricket" Scoring Marks
- Open/Double/In/Out Options for "01" Games
- Selectable Bullseye Score (25/50 or 50/50)
- Sound Effects Volume Adjustable
- AC adapter or Batteries (4x"AA") Options (Not Included)
- Easy Installation
- Included: Soft Tip Dartboard; Operating Manual; Installation Guide; Flights x 6; Shafts X 6; Extra Tips x 30; Barrels X 6; Throw Line; Screws.

Dardo elettronico ULTRA soft tip
- 15,5" di area bersaglio soft tip standard
- 29 giochi e 90 varianti
- Gioco simultaneo fino ad 8 giocatori
- Display LCD versione LARGE
- Opzioni double/in/out (25/50 o 50/50)
- Effetti sonori con volume regolabile
- Possibilità di adattatore AC o alimentazione con batterie (4 x tipo AA) - non inclusi
- Semplice installazione
- Include: dardo soft tip, manuale di funzionamento, guida d'installazione, 6 freccette complete, 30 puntalini di ricambio, linea distanza tiro, viti.



Art. O-7600
Electronic dartboard SMART soft tip
- 15.5 inch Soft Tip Worldwide Standard Size Target Area
- 7 inch LCD Colour Screen
- Firmware Updatable (by Sd Card)
- Included: Electronic Dartboard; Operating Manual; 1.2m mini USB Cable; Flights x 6; Shafts X 6; Extra Tips x 30; Barrels X 6; Throw Line; Screws.

Dardo elettronico SMART soft tip
- 15,5" di area bersaglio soft tip standard
- Display LCD a colori 7"
- Programma aggiornabile (tramite SD card)
- Include: dardo elettronico, manuale di funzionamento, 1,2 mt di cavo mini USB, 6 freccette complete, 30 puntalini di ricambio, linea distanza tiro, viti.

Art. O-5202
Dartboard COBRA SOFT
- Production dimension: 51.0x2.73x43.5cm
- 21 exciting games with 65 variations for players of all ages.
- 1 LED display with "bar type" cricket scoring system
- Suitable for 1 to 8 players
- Play up with computer in 4 levels: Professional/Advanced/Intermediate/Beginner
- 6 softtip darts; extra 40 tips for spare

Bersaglio COBRA SOFT
- Dimensioni prodotto: 51.0x2.73x43.5 cm
- 21 giochi con 65 varianti per giocatori di tutte le età
- 1 display LED con sistema di punteggio "bar type"
- Da 1 a 8 giocatori
- Giocabilità con computer in 4 livelli: professionale/avanzato/medio/principiante
- Include 6 puntalini soft, 40 puntalini di ricambio.



Art. W492077P
Electronic dartboard SCO-RE BATT. Soft tip
- Per freccette punta plastica
- Funzionamento: batteria

Bersaglio elettronico SCO-RE BATT. Soft tip
- Per freccette punta plastica
- Funzionamento: batteria

Art. O-2341
Adhesive for distance shooting range blue One80
Linea adesiva per distanza tiro, blu One80



Art. O-2340
Adhesive for distance shooting range black One80
Linea adesiva per distanza tiro, blu One80





- Art. W4807203
Electronic dartboard CB-50 soft tip
- 27 games with more than 159 variations
 - Cricket, sport and casino games
 - Possibility to change the difficulties level for each kind of game
 - Double-in and double-out with display and Master out option
 - 4 LED score indications up to max. 16 players
 - LED score indications for cricket game
 - Virtual match: possibility to choose up to 5 virtual competitors
 - 2 zones bullseye for a max playing surface
 - Electronic voice and digital soundeffects
 - 8 volume regulation possibilities
 - Keyboard function
 - dart cabinet and accessories tray included
 - Centralized computer control
 - 220V adaptor included
 - 12 soft tips included

- Match virtuale: possibilità di scelta tra 5 antagonisti virtuali
- Bullseye a 2 zone per una massima superficie di punteggio
- Voce elettronica ed effetti sonori digitali
- 8 possibilità di regolarizzazione del volume
- Funzione tastiera
- Contenitore dardo e portaccessori compresi
- Controllo computer centralizzato
- Adattatore 220V compreso
- Include 12 freccette soft

- Bersaglio elettronico CB-50 soft tip
- 27 giochi con più di 159 varianti
 - Cricket, sport e giochi da casinò
 - Possibilità di variare la difficoltà per ogni tipologia di gioco
 - Double-in e double-out con display e opzione Master out
 - 4 segnalazioni di punteggio a LED fino ad un massimo di 16 giocatori
 - Segnalazioni a LED per punteggi cricket

- Art. W807501
Dart PREMIUM SILVER
- 41 games with more than 210 options.
 - Wide ring pull out
 - Bull's eye incorporated 2 zones
 - Sounds effects
 - 5 Displays led for 16 players max.
 - Sound control
 - Support for darts and shelves
 - 12 Darts included

- Bersaglio PREMIUM SILVER
- 41 Giochi con più di 218 varianti.
 - Ampio anello tiro fuori
 - Bull's eye incorporato a due zone
 - Effetti sonori
 - Cinque display led per 16 giocatori massimo
 - Annuncio double in/double out
 - Controllo del volume
 - Supporto per freccette e ripiani integrati
 - 12 Freccette incluse



- Art. W815101
Dart cabinet XTREME ALL IN
Ideal set "all in" for each player.
- Original winmau "xtreme" board with bdo-logo.
 - High quality flexible cabinet with wooden venatures.
 - Detachable score
 - Dartboard included with 2 sets of darts and rhino of high quality flights
 - Self-adhesive shooting line
 - Checkout card
 - Cloth and chalks
 - Game rules

- Armadietto XTREME ALL IN
Fantastico set "all in", ideale per ogni giocatore.
- Tirassegno originale winmau "xtreme" con bdo-logo.
 - Armadietto richiudibile di alta qualità con venature legno.
 - Punteggio staccabile

- Dardo incluso con 2 set di freccette e alette rhino di alta qualità
- Linea a tiro autoadesiva
- Carta checkout
- Panno e gessetti
- Regole di gioco



- Bersaglio CB-25 LCD
- Da 1 a 8 giocatori
 - 29 Giochi con 90 varianti di gioco
 - Segmenti di colore blu e rossi con ragnatela bianca
 - Robusto armadietto in plastica
 - Maxi display LCD
 - Supporto per freccette e vassoio per accessori integrato
 - Effetti sonori e possibilità di impostare la lingua inglese
 - Sfida virtuale: sfide contro avversari virtuali (5 livelli di difficoltà)
 - Opzione di lancio e rimbalzo
 - Double in e double out con display e opzione master out
 - Funzione double - bull's eye: 2 zone bull's eye senza limitazioni di ragnatela per garantire il massimo numero di tiri
- Dotazione: 6 freccette + adattatore ca 220v
Dimensioni imballo: 55x55x4,5 cm
Peso kg. 3,5 ca

- Art. W808901
Dartomat CB-25 LCD
- Suitable for up to 8 players
 - 29 Games with more than 90 options
 - Segments blue and red with white spider
 - Strong resistant plastic cabinet
 - Maxi lcd display
 - Support for darts and accessories tray
 - Sound effects and setting of english language
 - Virtual function: possibility to choose up to virtual competitors (5 levels of difficulties)
 - Launch and rebound option
 - 2 Zone bull's eye without spieder restrictions for maximum frequency of shots.
- Included: 6 darts + ac 220v adapter
Packing size: 55x55x4,5 cm
Weight: 3,5 kg about



- Art. W4807201
Cabinet with automatic dart CB-90 soft dart
- 38 games with more than 211 variations
 - Cricket, sport and casino games
 - Possibility to change the difficulties level for each kind of game
 - Double-in and double-out with display and Master out option
 - 5 LED score indications up to max. 16 players
 - 4 LED score indications for cricket game
 - Virtual match: possibility to choose up to 5 virtual competitors
 - 2 zones bullseye for a max playing surface
 - 8 volume regulation possibilities
 - keyboard function
 - dart cabinet and accessories tray included
 - centralized computer control
 - 220V adaptor included
 - 12 soft tips included

- Bersaglio con cabinet elettronico CB-90 CW softtip*
- 38 giochi con più di 211 varianti
 - Cricket, Sport e giochi da casinò
 - Possibilità di variare la difficoltà per ogni tipologia di gioco
 - Double-in e double-out con display e opzione Master out
 - 5 segnalazioni di punteggio a LED fino ad un massimo di 16 giocatori
 - 4 segnalazioni a LED per punteggi cricket
 - Match virtuale: possibilità di scelta tra 5 antagonisti virtuali
 - Bullseye a 2 zone per una massima superficie di punteggio
 - 8 possibilità di regolarizzazione del volume
 - Funzione tastiera
 - Contenitore dardo e portaccessori compresi
 - Controllo computer centralizzato
 - Adattatore 220V compreso
 - Include 12 freccette soft



Art. O-5201
Dartautomat STARK DELUXE soft
Bersaglio STARK DELUXE soft

- Art. O-4109
Dartboard GLADIATOR II STEEL
- Staplefree construction, firmly located in backboard
 - Official size: 18"x11/2"
 - New Manufacturing Process
 - Patented ferrule system at the backboard
 - Gift box packing

- Dardo GLADIATOR II STEEL*
- Senza zanchette, fissato in modo ottimale sul retro
 - Misure standard: 18"x1-1/2"
 - Nuovo metodo di produzione
 - Sistema di fissaggio sul retro brevettato
 - Confezione regalo



- Art. O-4102
Dartboard TOPSCORE STEEL
- Official size: 18"x1-1/2"
 - Staple free bullseye
 - Suitable for steeltip and softtip darts
 - Gift box packaging
 - Supplied with mounting bracket and instructions

- Bersaglio TOPSCORE STEEL*
- Misure standard: 18"x1-1/2"
 - Bullseye privo di zanchette
 - Confezione regalo
 - Fornito con fascia per il montaggio ed istruzioni

Art. W4806902
 Dartboard WM BLADE V steel tip
 Dartboard used in the official competition B.D.O.
 Supplied with an extra thin spider.
 Longlife in comparison to the other models in bristle.
 Supplied with rota lock system which avoid the rotation of the spider.
 - Weight kg.5
 - Diameter 45 cm
 - Thickness 4 cm



Bersaglio WM BLADE V steel tip
 Dardo usato nelle competizioni ufficiali della B.D.O.
 Dotato di ragnatela extra sottile.
 Maggior durata nel tempo rispetto agli altri modelli in setola.
 Nuovo rota lock system che impedisce la rotazione della ragnatela.
 - Peso kg. 5
 - Diametro 45 cm
 - Spessore 4 cm



Art. W4807101
 Dartboard SOFT 2-LOCH
 - Suggested for training
 - Suitable for softdarts
 - 6 soft darts included

Bersaglio SOFT 2-LOCH
 - Bersaglio ideale per allenamento
 - Adatto a freccette soft
 - 6 freccette soft incluse

DARTS/FRECCETTE

Dart Standard, 1/4 BSF
 Freccetta Standard, 1/4 BSF

Sold individually or in boxes of 100 pcs
 Vendute singolarmente o in box da 100 pz



TOP PRODUCT



9 gr	D-0101901	D-0101904	D-0101907	D-0101909
------	-----------	-----------	-----------	-----------

Dart Serie Ht, 1/4 BSF
 Freccetta Serie Ht, 1/4 BSF

Sold individually or in boxes of 100 pcs
 Vendute singolarmente o in box da 100 pz



TOP PRODUCT



16 gr	D-10044	D-10042	D-10043	D-10041
-------	---------	---------	---------	---------

DARTS & ACCESSORIES - DARDI E ACCESSORI

Dart Super Slim, 1/4 BSF
Freccetta Super Slim, 1/4 BSF

Sold individually or in boxes of 100 pcs
Vendute singolarmente o in box da 100 pz



16 gr	D-1001602	D-1001607	D-1001608	D-1001609
18 gr	D-1001611	D-1001612	D-1001613	D-1001610

DARTS & ACCESSORIES - DARDI E ACCESSORI

Dart VS, 1/4 BSF
Freccetta VS, 1/4 BSF

Sold individually or in boxes of 100 pcs
Vendute singolarmente o in box da 100 pz



16 gr	D-1002801	D-1002809
14 gr	D-1002301	D-1002309

Dart Fly Fast, 1/4 BSF
Freccetta Fly Fast, 1/4 BSF

Sold individually or in boxes of 100 pcs
Vendute singolarmente o in box da 100 pz



16 gr	D-01023G	D-01023R	D-01023B	D-01023N



	18 gr
1/4 BSF-2BA	D-70034-18



	18 gr
2BA-2BA	D-70032-18

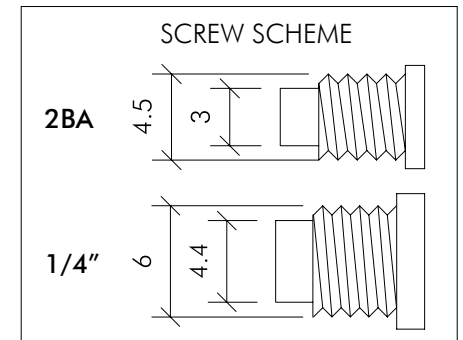

DARTTIPS PACKED/PUNTALINI

Darttip Nir / Punta Nir



1000 pcs	2BA	421009
25 mm	1/4 BSF	421209

Darttip Goldstar / Punta Goldstar



500 pcs - 30 mm	2BA	D-60641
1000 pcs - 30 mm	1/4 BSF	D-40001

Darttip Karella Special / Punta Karella Special



500 pcs - 28 mm	2BA	W4804901	W4804902
-----------------	-----	----------	----------

Darttip Prp-Tip / Punta Pro-Tip



1000 pcs - 24.5 mm	2BA	W4805103	W4805101
--------------------	-----	----------	----------

Darttip Evo / Punta Evo



50 pcs - 28 mm	2BA	371011	371010	371012	371013	371009
500 pcs - 28 mm	2BA	371006	371005	371007	371008	371004

Darttip Longlife sht / Punta Longlife sht



100 pcs - 26 mm	2BA	BU19-60711R	BU19-60711BL	BU19-60711B	BU19-60711
1000 pcs - 26 mm	2BA	BU19-60701R	-	BU19-60701B	BU19-60701

Darttip Tournament Championship Newgeneration / Punta Tournament Championship Newgeneration



100 pcs - 22 mm	2BA	P2000
-----------------	-----	-------

Darttip Tournament Championship short / Punta Tournament Championship short



100 pcs - 19 mm	2BA	P3000
-----------------	-----	-------

FLIGHT/CODE

Flight Standard 1/4 BSF
Code Standard 1/4 BSF



Sold individually or in boxes of 100 pcs
Vendute singolarmente o in box da 100 pz

1/4 BSF	D-1000701	D-1000704	D-1000707	D-1000709
---------	-----------	-----------	-----------	-----------

Flight HT 2BA
Code HT 2BA



Sold individually or in boxes of 100 pcs
Vendute singolarmente o in box da 100 pz

2BA	D-1000901	D-1000904	D-1000907	D-1000909
-----	-----------	-----------	-----------	-----------

Flight Super Slim 2BA
Code Super Slim 2BA



Sold individually or in boxes of 100 pcs
Vendute singolarmente o in box da 100 pz

2BA	D-1001802	D-1001807	D-1001808	D-1001809
-----	-----------	-----------	-----------	-----------

Flight Fly Fast 2BA
Code Fly Fast 2BA

Sold individually or in boxes of 100 pcs
Vendute singolarmente o in box da 100 pz



2BA	D-1001001	D-1001004	D-1001007	D-1001009

Flight VS 2BA
Code VS 2BA

Sold individually or in boxes of 100 pcs
Vendute singolarmente o in box da 100 pz



2BA	D-1002401	D-1002409

art. W4809701
Tool to make holes on wings
Macchinetta per bucare alette



DARTSOFT



Dart soft VHD Meteor
Freccette soft VHD Meteor
18 gr O-6023



Dart soft Bavaria Fb
Freccette soft Favaria Fb
18 gr O-6509



Dart soft Paladin
Freccette soft Paladin
18 gr O-6062



Dart soft
Chameleon Saphire
Freccette soft
Chameleon Saphire
18 gr O-6677



Dart soft Dragon
Freccette soft Dragon
18 gr O-6042



Dart soft Reactive
Freccette soft Reactive
16 gr O-9893



Dart soft Arcane Voice
Freccette soft Arcane Voice

18 gr O-6082

Dart soft Strike
Freccette soft Strike

16 gr O-6123

Dart soft Dryad
Freccette soft Dryad

16 gr O-6142

Dart soft Intruder
Freccette soft Intruder

16 gr O-6201



Dart soft Xiao Qiao
Freccette soft Xiao Qiao

16 gr O-6852

Dart soft Meng
Freccette soft Meng

17 gr O-6854



Dart soft Vapor
Freccette soft Vapor

16 gr O-6321

Dart soft Comet
Freccette soft Comet

16 gr O-6165



Dart soft Wo Long
Freccette soft Wo Long

18 gr O-6831

Dart soft Blaster
Freccette soft Blaster

16 gr O-6241

Dart soft Speed
Freccette soft Speed

16 gr O-6281



Dart soft Flash
Freccette soft Flash
16 gr | O-6261



Dart soft Burst
Freccette soft Burst
16 gr | O-6221



Softdart Blackout
Freccette soft Blackout
18 gr | W4730001



Softdart Ton Machine
Freccette soft Ton Machine
18 gr | W98731501

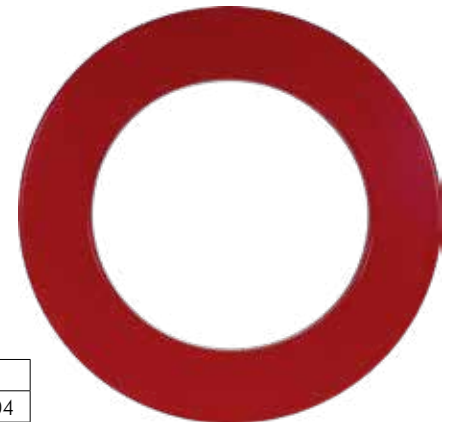

Dartboard surround / Proteggi muro
Ø ext 70 cm; Ø int 46 cm; h. 3,3 cm

O-2601	O-2602	O-2603	O-2604



Softdart Sniper
Freccette set Sniper
20 gr | W98729502



Softdart Apocalypse
Freccette soft Apocalypse
16 gr | W98733001



Softdart Marvyn King Silver
Freccette set Marvyn King Silver
18 gr | W98723601



Darts steel Karella St-4
Freccette steel Karella St-4
18 gr | W4607004

Dart case "The Pak"
Porta freccette "The Pak"



black / nero	blue / blu	red / rosso	yellow / giallo	orange / arancio
W4802301	W4802302	W4802303	W4802304	W4802307



lilac / lilla	silver / argento	green / verde	mimetic / mimetico	hero
W4802311	W4802312	W4802313	W4802314	W4801801



leather / pelle	pink / rosa	leo
W4802001	W4802308	W4802309



Art. W4806701
Shaft doc made of alu
Chiavetta levapunte



Art. O-2505
Dart case Holdall
Astuccio Holdall



Art. O-2558
Dart case happy dart black Dragon
Astuccio happy dart black Dragon



Art. O-2588
Dart case happy dart blue/white
Astuccio happy dart blue/white



Dart case "Master Pak"
Porta freccette "Master Pak"

black / nero	blue / blu
W4802305	W4802306



Vending machines & gadget
Distributori & gadget

NOVA

Art. 19164
External size/Misure esterne: 34x134x46 cm



Coinshute can be programmed from 1 to 2 coins.
Options: 1 €, 1.50 € or 2 €
Packaging: 6 pcs per pallet

Gettoniera programmabile 1 o 2 monete.
Prezzo di vendita 1 €, 1.50 € o 2 €
Imballaggio: 6 pz per pallet

CAPSULE	CAPACITY
Ø 50 mm	195
Ø 60 mm	110
Ø 68 mm	85

LUXOR

Art. 19130
External size/Misure esterne: 53x150x53 cm



Packaging: 4 pcs per pallet
Imballaggio: 4 pz per pallet

CAPSULE	CAPACITY
Ø 90 mm	160/140
Ø 100 mm	120/100

NILO

Art. 19161
External size/Misure esterne: 46x150x46 cm



Packaging: 8 pcs per pallet
Options: board
Imballaggio: 8 pz per pallet
Optional: pedana

CAPSULE	CAPACITY
Ø 68 mm	220
Ø 90 mm	90
uovo	180

HORUS

Art. 19133
External size/Misure esterne: 43x144x46 cm



Packaging: 8 pcs per pallet
Options: board
Imballaggio: 8 pz per pallet
Optional: pedana

CAPSULE	CAPACITY
Ø 68 mm	150
Ø 90 mm	70
uovo	130

EXPE CAFFEE

Art. 19158
External size/Misure esterne: 34x65x33 cm



Net weight: 7 kg
Capacity: 90 capsules
Packaging: 8 pcs per pallet
Options: board

Peso netto: 7 kg
Capacità: 90 capsule
Imballaggio: 18 pz per pallet
Optional: pedana

STREET PINBALL (con ruote)

Art. 19131
External size/Misure esterne: 42x114x60 cm



Packaging: 9 pcs per pallet
Imballaggio: 9 pz per pallet

PALLINE	CAPACITY
Ø 25/32 mm	300/250

SETI

Art. 19156
External size/Misure esterne: 24X46X24 cm



Packaging: 96 pcs per pallet
Options: board
Imballaggio: 96 pz per pallet
Optional: pedana

PALLINE	CAPACITY
Ø 25/32 mm	300/250
mix	-



Art. 19175
Kit mix for seti/
Kit mix per Seti

PEDANE



Art. 19144
Board without wheels for Horus and Nilo
Pedana senza ruote per Horus e Nilo



Art. 19144R
Board with wheels for Horus and Nilo
Pedana con ruote per Horus e Nilo



Art. 17741
Board for Expe 9 and Expe Caffee
Pedana per Expe 9 e Expe Caffee



Art. 19190
Board double Seti
Pedana double Seti

CAPSULE Ø 90 mm



Art. 19120
Ball "Click&play" for vending machine
Capsula "Click and play"



Art. 19240
Empty plastic jar Laiv
Barattolo plastica vuoto



Art. 19177
Ball empty 90 mm
Capsula vuota

Art. 19121
Ball "Happy toy" for vending machine
Capsula "Happy toy"

CAPSULE Ø 69 mm



e molte altre...

Difresh®



Art. 19340
Vending machine Difresh
Distributore Difresh



ON REQUEST
Minimum quantity 50 pcs

A RICHIESTA
Quantitativo minimo 50pz



Art. 19341
Refill Difresh - mixed colours
Ricarica Difresh - colori assortiti



SPORT & free time
SPORT & tempo libero



Art. W420501
Badminton set for 4 players (with net)
Badminton set per 4 giocatori (rete inclusa)



Art. W421702
Badminton racket PRO
Racchetta Badminton PRO

Art. W421501
Racket Bandito Master
Racchetta Bandito Master



Art. W425001
Racket Badminton Bandito speed (set 2 pcs)
Racchetta Badminton Bandito speed (set 2 pz)



Art. W440701
Beachball rackets (set 2 pcs) balls included
Racchette per beachball (set 2 pz) palline incluse



Art. W422702
Balls for Badminton (6 pcs)
Palline piumate Profi (set 6 pz)



Art. W460501
Trampolin Bandito Ø122 cm, weight: ca.13 kg
Trampolino Bandito Ø122 cm, peso: ca.13 kg





Art. W450401
Heavy bag Bandito Kiddystar.
Sizes: ca. 40 x 15 cm. Weight: 1 kg
Box gloves junior included.
Sacco box Bandito Kiddystar.
Misure: ca. 40 x 15 cm. Peso: 1 kg
Guantoni junior inclusi.



Art. W450501
Heavy bag Bandito Junior.
Sizes: ca. 60 x 25 cm.
Weight: 10 kg
Box gloves junior included.
Sacco box Bandito Junior.
Misure: ca. 60 x 25 cm.
Peso: 10 kg
Guantoni junior inclusi.



Glove for box
Guantone box

S/M	M/L	L/XL	XL/XX
W451001	W451002	W451003	W451004



Art. W450503
Heavy bag Bandito Pro
Sizes: ca. 90 x 35 cm.
Weight: 24 kg
Sacco box Bandito Pro
Misure: ca. 90 x 35 cm.
Peso: 24 kg



Art. W450701
Hooks for heavy bag
Ganci per sacco da box

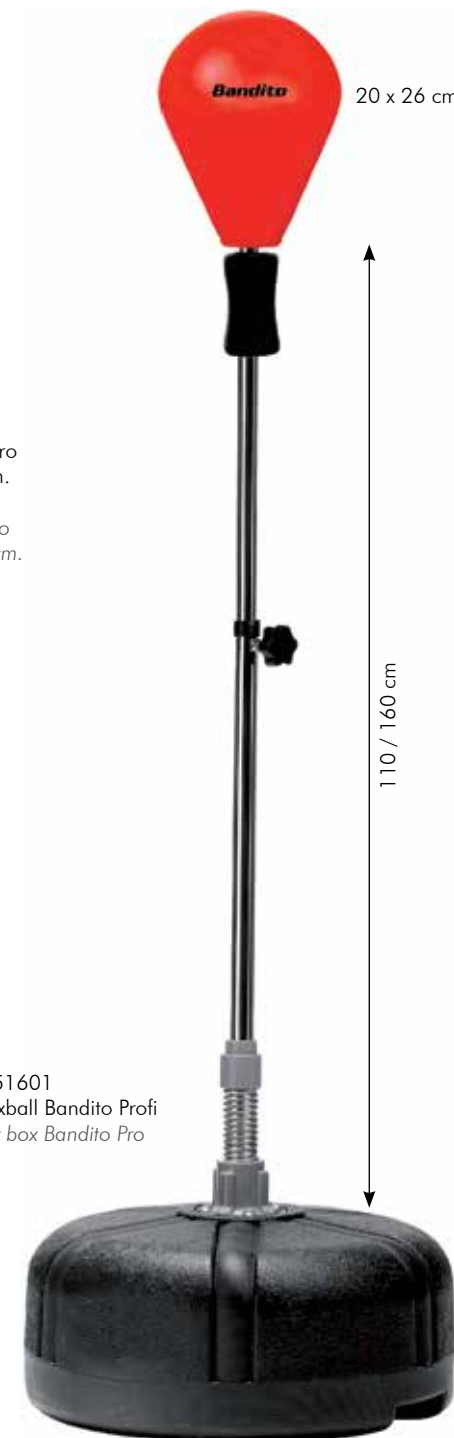

20 x 26 cm

110 / 160 cm

Art. W451601
Standball Bandito Profi
Base per box Bandito Pro



Art. W430501
Set bocce with bag
Set bocce con custodia



Art. W441001
Shangai big, 25 rods, 95 cm long
Shangai gigante. 25 aste, lunghezza 95 cm.



Art. W443101
Goal for funairhockey (1 pc). Sizes: 90 x 60 x 42 cm. Weight: 3 kg.
Porta per funairhockey (1 pz). Misura: 90 x 60 x 42 cm. Peso: 3 kg.



Art. W441501
Funhockey rackets (set 2 pcs) with balls
Racchette funhockey (set 2 pz) con palline



Art. W442501
Balls for funk hockey (4 pcs) - Ø 72 mm. Weight: 23 gr.
Palline per funhockey (4 pz) - Ø 72 mm. Peso: 23 gr.

The company reserves the right to apply any modification to materials, descriptions or configuration without any previous notice.
La ditta ha la possibilità di applicare qualsiasi modifica a materiali, descrizioni o caratteristiche senza obbligo di notifica preventiva.



NORDITALIA RICAMBI S.R.L

Via Spaino, 2 - 22066 Mariano C.se (Co) - Italy
Tel. +39 031 746542 - Fax. +39 0313551044
www.norditalia.it - info@norditalia.it